

## Relay Module - PLC-RSC- 24DC/1IC/ACT - 2967604

Please be informed that the data shown in this PDF Document is generated from our Online Catalog. Please find the complete data in the user's documentation. Our General Terms of Use for Downloads are valid (<http://phoenixcontact.com/download>)



PLC-INTERFACE for high switch-on currents, consisting of PLC-BSC.../1 IC/ACT basic terminal block with screw connection and plug-in miniature relay, for mounting on DIN rail NS 35/7,5, max. switch-on current up to 130 A, 1 N/O contact, input voltage 24 V DC

### Your advantages

- Direct connection of load return line thanks to actuator version
- Efficient connection to system cabling using V8 adapter
- Safe isolation according to DIN EN 50178 between coil and contact
- Functional plug-in bridges
- Max. inrush current of 130 A



### Key Commercial Data

Packing unit	10 pc
GTIN	 4 017918 169794
GTIN	4017918169794
Weight per Piece (excluding packing)	67.980 g
Custom tariff number	85364900
Country of origin	India

### Technical data

#### Note

Utilization restriction	EMC: class A product, see manufacturer's declaration in the download area
-------------------------	---

#### Dimensions

Width	14 mm
Height	80 mm
Depth	94 mm

#### Ambient conditions

Ambient temperature (operation)	-40 °C ... 60 °C
---------------------------------	------------------

# Relay Module - PLC-RSC- 24DC/1IC/ACT - 2967604

## Technical data

### Ambient conditions

Ambient temperature (storage/transport)	-40 °C ... 85 °C
---	------------------

### Coil side

Nominal input voltage $U_N$	24 V DC
Typical input current at $U_N$	18 mA
Typical response time	8 ms
Typical release time	10 ms
Protective circuit	Reverse polarity protection Polarity protection diode
	Free-wheeling diode Damping diode
Operating voltage display	Yellow LED
Power dissipation for nominal condition	0.43 W

### Contact side

Contact type	1 N/O contact
Type of switch contact	Single contact
Contact material	AgSnO
Maximum switching voltage	250 V AC/DC (The separating plate PLC-ATP should be installed for voltages larger than 250 V (L1, L2, L3) between identical terminal blocks in adjacent modules. Potential bridging is then carried out with FBST 8-PLC... or ...FBST 500...)
Minimum switching voltage	12 V (at 100 mA)
Min. switching current	100 mA (at 12 V DC)
Maximum inrush current	80 A (20 ms)
	130 A (peak, at capacitive load, 230 V AC, 24 µF)
Limiting continuous current	6 A
	10 A (the value is permissible if both connections 13, both connections 14 and both connections BB are bridged)
Interrupting rating (ohmic load) max.	144 W (at 24 V DC)
	58 W (at 48 V DC)
	48 W (at 60 V DC)
	50 W (at 110 V DC)
	80 W (at 220 V DC)
	85 W (for 250 V DC)
	1500 VA (for 250 V AC)
Interrupting rating (ohmic load) max. bridged	240 W (for 24 V DC. The value is permissible if both connections 13, both connections 14 and both connections BB are bridged.)
	2500 VA (for 250 V AC. The value is permissible if both connections 13, both connections 14 and both connections BB are bridged.)
Switching capacity min.	1200 mW
Switching capacity	2 A (at 24 V, DC13)
	0.2 A (at 110 V, DC13)
	0.2 A (at 250 V, DC13)
	6 A (at 24 V, AC15)
	6 A (at 120 V, AC15)

# Relay Module - PLC-RSC- 24DC/1IC/ACT - 2967604

## Technical data

### Contact side

	6 A (at 250 V, AC15)
--	----------------------

### Connection data input side

Connection name	Coil side
Connection method	Screw connection
Stripping length	8 mm
Screw thread	M3
Conductor cross section solid	0.14 mm <sup>2</sup> ... 2.5 mm <sup>2</sup>
Conductor cross section flexible	0.14 mm <sup>2</sup> ... 2.5 mm <sup>2</sup>
	0.2 mm <sup>2</sup> ... 2.5 mm <sup>2</sup> ( )
	2x 0.5 mm <sup>2</sup> ... 1.5 mm <sup>2</sup> ( )
Conductor cross section AWG	26 ... 14

### Connection data output side

Connection name	Contact side
Connection method	Screw connection
Stripping length	8 mm
Screw thread	M3
Conductor cross section solid	0.14 mm <sup>2</sup> ... 2.5 mm <sup>2</sup>
Conductor cross section flexible	0.14 mm <sup>2</sup> ... 2.5 mm <sup>2</sup>
	0.2 mm <sup>2</sup> ... 2.5 mm <sup>2</sup> ( )
	2x 0.5 mm <sup>2</sup> ... 1.5 mm <sup>2</sup> ( )
Conductor cross section AWG	26 ... 14

## General

Note	Separating plate PLC-ATP must be installed for voltages larger than 250 V (L1, L2, L3) between identical terminal blocks in adjacent modules.
	The PLC-ATP separating plate should be installed for safe isolation between adjacent modules
	The PLC-ATP separating plate is required at the start and end of every PLC terminal strip.
	The system installer must ensure the touch protection of the product (at voltages > 25 V AC/60 V DC). The product is a built-in device without protection against direct contact.
Test voltage relay winding/relay contact	4 kV AC (50 Hz, 1 min.)
Operating mode	100% operating factor
Degree of protection	RT II (Relay)
	IP20 (Relay base)
Mechanical service life	3x 10 <sup>7</sup> cycles
Mounting position	any
Assembly instructions	In rows with zero spacing

## Standards and Regulations

Connection in acc. with standard	CUL
----------------------------------	-----

# Relay Module - PLC-RSC- 24DC/1IC/ACT - 2967604

## Technical data

### Standards and Regulations

Designation	Standards/regulations
Standards/regulations	EN 50178
	EN 61810-1
Rated insulation voltage	250 V AC
Rated surge voltage	6 kV
Insulation	Safe isolation, reinforced insulation
Degree of pollution	2
Overvoltage category	III
Flammability rating according to UL 94	V0

### Environmental Product Compliance

REACH SVHC	Lead 7439-92-1
China RoHS	Environmentally Friendly Use Period = 50
	For details about hazardous substances go to tab "Downloads", Category "Manufacturer's declaration"

## Drawings

Diagram

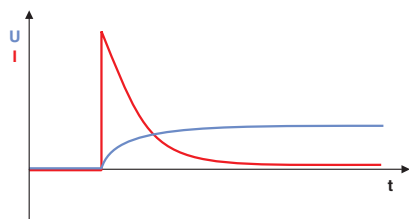

Basic behavior of capacitive loads:  
 - Very high inrush current  
 - Voltage increases with an e-function

Diagram

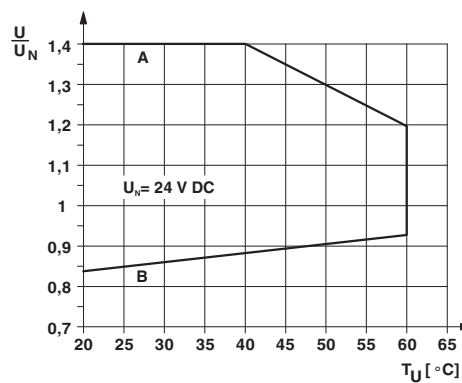

Curve A  
 Maximum permissible continuous voltage  $U_{max}$  with limiting continuous current on the contact side (see relevant technical data)  
 Curve B  
 Minimum permissible operate voltage  $U_{op}$  after pre-excitation (see relevant technical data)

# Relay Module - PLC-RSC- 24DC/1IC/ACT - 2967604

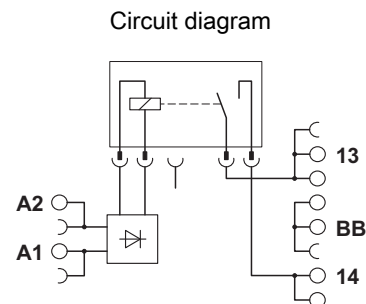
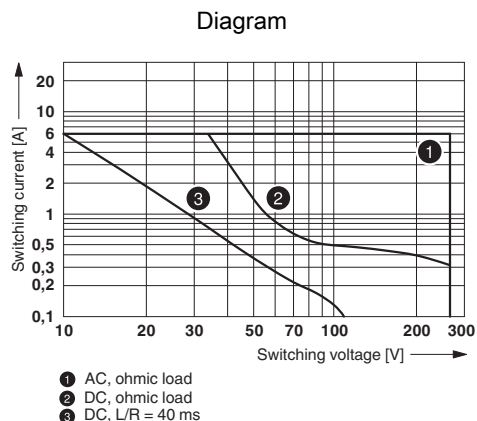

Interrupting rating

## Articles in set

Relay base - PLC-BSC- 24DC/ 1IC/ACT - 2967837



14 mm PLC basic terminal block for high switch-on currents with screw connection, without relay or solid-state relay, for mounting on DIN rail NS 35/7,5, with load return line connection (BB), 1 N/O contact, input voltage 24 V DC

Single relay - REL-MR- 24DC/1IC - 2961341



Plug-in miniature power relay, with power contact for high switch-on currents, 1 N/O contact, input voltage 24 V DC

## Classifications

eCl@ss

eCl@ss 5.0	27371601
eCl@ss 5.1	27371600
eCl@ss 6.0	27371600
eCl@ss 7.0	27371601
eCl@ss 8.0	27371601
eCl@ss 9.0	27371601

ETIM

ETIM 2.0	EC001437
ETIM 3.0	EC001437
ETIM 4.0	EC001437

# Relay Module - PLC-RSC- 24DC/1IC/ACT - 2967604

## Classifications

### ETIM

ETIM 5.0	EC001437
ETIM 6.0	EC001437

### UNSPSC

UNSPSC 6.01	30211916
UNSPSC 7.0901	39121515
UNSPSC 11	39121515
UNSPSC 12.01	39121515
UNSPSC 13.2	39122334

## Approvals

### Approvals

#### Approvals

PRS / GL / UL Listed / UL Recognized / cUL Recognized / cUL Listed / EAC / cULus Recognized / cULus Listed

#### Ex Approvals

### Approval details

PRS		<a href="http://www.prs.pl/">http://www.prs.pl/</a>	TE/2109/880590/16
-----	---	---	-------------------

GL		<a href="http://exchange.dnv.com/tari/">http://exchange.dnv.com/tari/</a>	46016-03 HH
----	---	---	-------------

UL Listed		<a href="http://database.ul.com/cgi-bin/XYV/template/LISEXT/1FRAME/index.htm">http://database.ul.com/cgi-bin/XYV/template/LISEXT/1FRAME/index.htm</a>	FILE E 172140
-----------	---	---	---------------

UL Recognized		<a href="http://database.ul.com/cgi-bin/XYV/template/LISEXT/1FRAME/index.htm">http://database.ul.com/cgi-bin/XYV/template/LISEXT/1FRAME/index.htm</a>	FILE E 238705
---------------	---	---	---------------

cUL Recognized		<a href="http://database.ul.com/cgi-bin/XYV/template/LISEXT/1FRAME/index.htm">http://database.ul.com/cgi-bin/XYV/template/LISEXT/1FRAME/index.htm</a>	FILE E 238705
----------------	---	---	---------------

# Relay Module - PLC-RSC- 24DC/1IC/ACT - 2967604

## Approvals

cUL Listed		<a href="http://database.ul.com/cgi-bin/XYV/template/LISEXT/1FRAME/index.htm">http://database.ul.com/cgi-bin/XYV/template/LISEXT/1FRAME/index.htm</a>	FILE E 172140
------------	--	---	---------------

EAC		RU C- DE.A*30.B.01082
-----	--	--------------------------

cULus Recognized	
------------------	--

cULus Listed	
--------------	--

## Accessories

### Accessories

#### Bridge

Continuous plug-in bridge - FBST 500-PLC RD - 2966786



Continuous plug-in bridge, length: 500 mm, color: red

Continuous plug-in bridge - FBST 500-PLC BU - 2966692



Continuous plug-in bridge, length: 500 mm, color: blue

Continuous plug-in bridge - FBST 500-PLC GY - 2966838



Continuous plug-in bridge, length: 500 mm, color: gray

## Relay Module - PLC-RSC- 24DC/1IC/ACT - 2967604

### Accessories

Single plug-in bridge - FBST 6-PLC RD - 2966236



Single plug-in bridge, length: 6 mm, number of positions: 2, color: red

---

Single plug-in bridge - FBST 6-PLC BU - 2966812



Single plug-in bridge, length: 6 mm, number of positions: 2, color: blue

---

Single plug-in bridge - FBST 6-PLC GY - 2966825



Single plug-in bridge, length: 6 mm, number of positions: 2, color: gray

---

Single plug-in bridge - FBST 8-PLC GY - 2967688



Single plug-in bridge, length: 8 mm, number of positions: 2, color: gray

---

Single plug-in bridge - FBST 14-PLC BK - 2967691



Single plug-in bridge, length: 14 mm, number of positions: 2, color: black

---

### Controller board

## Relay Module - PLC-RSC- 24DC/1IC/ACT - 2967604

### Accessories

System connection - PLC-V8L/FLK14/OUT - 2299660



V8 adapter for 8 x PLC-INTERFACE (14 mm); Controller: PLC system cabling of output cards; connection 1: Plug connection (Can be snapped onto 8x PLC-INTERFACE terminals); connection 2: 1x IDC/FLK pin strip (14-position); number of channels: 8; control logic: positive switching

System connection - PLC-V8L/FLK14/OUT/M - 2304306



V8 adapter for 8 x PLC-INTERFACE (14 mm); Controller: PLC system cabling of output cards; connection 1: Plug connection (Can be snapped onto 8x PLC-INTERFACE terminals); connection 2: 1x IDC/FLK pin strip (14-position); number of channels: 8; control logic: negative switching

### DIN rail

DIN rail, unperforated - NS 35/ 7,5 V2A UNPERF 2000MM - 0801377



DIN rail, unperforated, Standard profile, width: 35 mm, height: 7.5 mm, acc. to EN 60715, material: Stainless steel V2A, uncoated, length: 2000 mm, color: silver

DIN rail perforated - NS 35/ 7,5 PERF 2000MM - 0801733



DIN rail perforated, Standard profile, width: 35 mm, height: 7.5 mm, acc. to EN 60715, material: Steel, galvanized, passivated with a thick layer, length: 2000 mm, color: silver

DIN rail, unperforated - NS 35/ 7,5 CU UNPERF 2000MM - 0801762



DIN rail, unperforated, Standard profile, width: 35 mm, height: 7.5 mm, acc. to EN 60715, material: Copper, uncoated, length: 2000 mm, color: copper-colored

## Relay Module - PLC-RSC- 24DC/1IC/ACT - 2967604

### Accessories

DIN rail, unperforated - NS 35/15 UNPERF 2000MM - 1201714



DIN rail, unperforated, Standard profile, width: 35 mm, height: 15 mm, similar to EN 60715, material: Steel, galvanized, passivated with a thick layer, length: 2000 mm, color: silver

---

DIN rail, unperforated - NS 35/15 CU UNPERF 2000MM - 1201895



DIN rail, unperforated, Standard profile, width: 35 mm, height: 15 mm, similar to EN 60715, material: Copper, uncoated, length: 2000 mm, color: copper-colored

---

DIN rail, unperforated - NS 35/15-2,3 UNPERF 2000MM - 1201798



DIN rail, unperforated, Standard profile 2.3 mm, width: 35 mm, height: 15 mm, acc. to EN 60715, material: Steel, galvanized, passivated with a thick layer, length: 2000 mm, color: silver

---

DIN rail, unperforated - NS 35/15 AL UNPERF 2000MM - 1201756



DIN rail, unperforated, Standard profile, width: 35 mm, height: 15 mm, similar to EN 60715, material: Aluminum, uncoated, length: 2000 mm, color: silver

---

DIN rail perforated - NS 35/15 PERF 2000MM - 1201730



DIN rail perforated, Standard profile, width: 35 mm, height: 15 mm, similar to EN 60715, material: Steel, galvanized, passivated with a thick layer, length: 2000 mm, color: silver

---

## Relay Module - PLC-RSC- 24DC/1IC/ACT - 2967604

### Accessories

DIN rail, unperforated - NS 35/ 7,5 UNPERF 2000MM - 0801681



DIN rail, unperforated, Standard profile, width: 35 mm, height: 7.5 mm, acc. to EN 60715, material: Steel, galvanized, passivated with a thick layer, length: 2000 mm, color: silver

---

### Labeled terminal marker

Zack marker strip - ZB10,LGS:FORTL.ZAHLEN - 1053014



Zack marker strip, Strip, white, labeled, can be labeled with: CMS-P1-PLOTTER, printed horizontally: consecutive numbers 1 ... 10, 11 ... 20, etc. up to 991 ... 1000, mounting type: snap into tall marker groove, for terminal block width: 10.2 mm, lettering field size: 10.15 x 10.5 mm

---

### Partition plate

Separating plate - PLC-ATP BK - 2966841



Separating plate, 2 mm thick, required at the start and end of a PLC terminal strip. Furthermore, it is used for: visual separation of groups, safe isolation of different voltages of neighboring PLC relays in acc. with DIN VDE 0106-101, isolation

---

### Power module

Power terminal block - PLC-ESK GY - 2966508



Power terminal block, for the input of up to four potentials, for mounting on NS 35/7.5

---

### Screwdriver tools

Screwdriver - SZF 1-0,6X3,5 - 1204517



Actuation tool, for ST terminal blocks, also suitable for use as a bladed screwdriver, size: 0.6 x 3.5 x 100 mm, 2-component grip, with non-slip grip

## Relay Module - PLC-RSC- 24DC/1IC/ACT - 2967604

### Accessories

#### Terminal marking

Zack marker strip - ZB10/WH-100:UNBEDRUCKT - 5060883



Zack marker strip, Strip, white, unlabeled, can be labeled with: CMS-P1-PLOTTER, PLOTMARK, mounting type: snap into tall marker groove, for terminal block width: 10.2 mm, lettering field size: 10.15 x 10.5 mm

Zack marker strip - ZB 10:UNBEDRUCKT - 1053001



Zack marker strip, Strip, white, unlabeled, can be labeled with: PLOTMARK, CMS-P1-PLOTTER, mounting type: snap into tall marker groove, for terminal block width: 10.2 mm, lettering field size: 10.5 x 10.15 mm

Marker for terminal blocks - UC-TM 12 - 0819194



Marker for terminal blocks, Sheet, white, unlabeled, can be labeled with: BLUEMARK ID COLOR, BLUEMARK ID, BLUEMARK CLED, PLOTMARK, CMS-P1-PLOTTER, mounting type: snap into tall marker groove, for terminal block width: 12 mm, lettering field size: 11.45 x 10.5 mm

Marker for terminal blocks - UCT-TM 12 - 0829144



Marker for terminal blocks, Sheet, white, unlabeled, can be labeled with: TOPMARK NEO, TOPMARK LASER, BLUEMARK ID COLOR, BLUEMARK ID, BLUEMARK CLED, THERMOMARK PRIME, THERMOMARK CARD 2.0, THERMOMARK CARD, mounting type: snap into tall marker groove, for terminal block width: 12 mm, lettering field size: 10.8 x 9.6 mm

#### Spare parts

Relay base - PLC-BSC- 24DC/ 1IC/ACT - 2967837



14 mm PLC basic terminal block for high switch-on currents with screw connection, without relay or solid-state relay, for mounting on DIN rail NS 35/7,5, with load return line connection (BB), 1 N/O contact, input voltage 24 V DC

## Relay Module - PLC-RSC- 24DC/1IC/ACT - 2967604

### Accessories

Single relay - REL-MR- 24DC/1IC - 2961341



Plug-in miniature power relay, with power contact for high switch-on currents, 1 N/O contact, input voltage 24 V DC

---

Phoenix Contact 2019 © - all rights reserved  
<http://www.phoenixcontact.com>