

Features

Regulated Converter

- 300W baseplate-cooled, fan-less operation
- 550W peak power or forced air rating
- Industrial, household and medical 2MOPP ready
- Standby power consumption <0.5W
- Aux Output: 5VSB / 1A
- Signals: remote sensing and ON/OFF control



RACM550-G

550 Watt

5" x 3"

Open Frame or Enclosed Single Output



Description

The RACM550 Series is designed to support up to 300 Watt continuous output power without fan cooling. The compact 5" x 3" baseplate design enables direct heat dissipation through metal housings in the application. Up to 550 watts are available to drive dynamic loads for several seconds of peak power or with forced air for even longer time frames. A fan output is on board as standard as well as a 5V/1A VSB output for applications with housekeeping circuits and on/off control. A wide input range of 80 to 264VAC, up to 5000m operating altitude and international safety agency certifications make the series worldwide suitable for BF-rated applied parts, household and industrial ITE applications.

Selection Guide

Part Number	Input Voltage Range [VAC]	Nom. Output Voltage [VDC]	Max. Output Current ⁽¹⁾ [A]	Efficiency typ. ⁽²⁾ [%]
RACM550-24SG ⁽³⁾	80-264	24	22.92	93
RACM550-36SG ⁽³⁾	80-264	36	15.28	93
RACM550-48SG ⁽³⁾	80-264	48	11.46	93
RACM550-56SG ⁽³⁾	80-264	56	9.82	94

Notes:

Note1: With forced air cooling (2.5m/s) + conduction cooling + refer to "Line Derating"

Note2: Efficiency is tested at nominal input and full load at +25°C ambient

Compatible Connectors

RECOM Part Number	Description
R-L2001D-Y-2x2P	mating housing
R-PHD2.0	crimp contact

Model Numbering



Notes:

Note3: add suffix "/OF" for open frame version

add suffix "/ENC" for enclosed version (MOQ may apply for some models)

Ordering Examples:

RACM550-24SG/OF	24Vout	Single	open frame
RACM550-36SG/ENC	36Vout	Single	enclosed

Specifications (measured @ Ta= 25°C, rated input, rated load unless otherwise stated)

BASIC CHARACTERISTICS				
Parameter	Condition	Min.	Typ.	Max.
Nom. Input Voltage		100VAC		240VAC
Input Voltage Range ⁽⁴⁾		80VAC 120VDC		264VAC 370VDC
Input Current	115VAC 230VAC			6.5A 3.0A

continued on next page

- UL62368-1 (TÜV NRTL) certified
- CAN/CAS C22.2 No. 62368-1 certified
- IEC/EN62368-1 certified
- ANSI/AAMI ES60601-1 (ed 3.1) certified
- CAN/CSA-C22.2 No. 60601-1:14 certified
- IEC/EN60335-1 certified
- IEC/EN60950-1 certified
- IEC/EN60601-1 (ed. 3.1)
- EN60601-1-2 (ed. 4) certified
- IEC/EN61558-1 certified
- IEC/EN61558-2-16 certified
- EN55032 compliant
- EN55024 compliant
- CB Reports

Specifications (measured @ Ta= 25°C, rated input, rated load unless otherwise stated)

BASIC CHARACTERISTICS

Parameter	Condition		Min.	Typ.	Max.
No load Power Consumption					2W
Standby Power	main output OFF, VSB Output unloaded				0.5W
Input Frequency Range	AC input		47Hz		63Hz
ErP Lot 6 Standby Mode Conformity (VSB Output Load Capability)	Input Power= 1W (main output= standby mode)				450mW
Minimum Load			0%		
Power Factor	115VAC 230VAC		0.98 0.95	0.99 0.97	
Start-up Time	main output VSB Output	115VAC/230VAC 115VAC/230VAC		400ms 140ms	
Rise Time	main output VSB Output	115VAC/230VAC 115VAC/230VAC		15ms 5ms	
Hold-up Time	main output VSB Output	115VAC/230VAC, 550W 115VAC/230VAC		15ms 130ms	
Output Ripple and Noise ⁽⁶⁾	20MHz BW @ 25°C	main output	1% of Vout nom. max.		
		VSB Output			120mVp-p

Notes:

Note4: The products were submitted for safety files at AC-input operation. For DC-input make sure that sufficient fuses are used

Note5: Measurements are made with a 12" twisted pair-wire terminated with a 0.1µF and 10µF parallel capacitor

Efficiency vs. Load

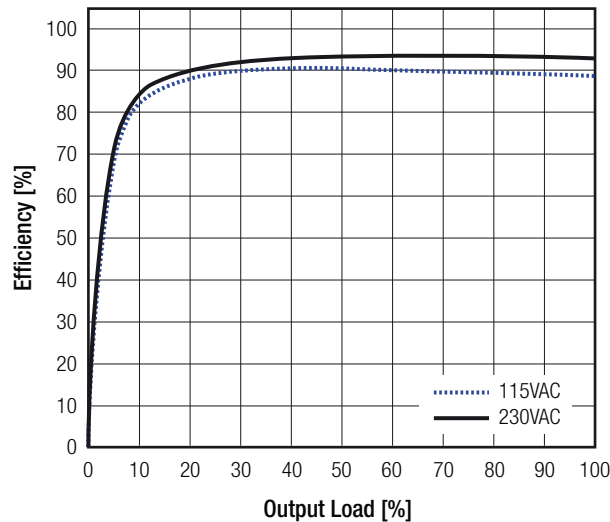

REGULATIONS

Parameter	Condition		Value
Output Accuracy	main output		±3.0% max.
	VSB output		±4.0% max.
Line Regulation	low line to high line, full load	main output / VSB output	±1.0% max.
Load Regulation ⁽⁶⁾	10% to 100% load	main output / VSB output	1.0% max.

Notes:

Note6: Operation below 10% load will not harm the converter, but specifications may not be met

Specifications (measured @ Ta= 25°C, rated input, rated load unless otherwise stated)

ADDITIONAL FEATURES

Parameter	Condition		Min.	Typ.	Max.
VSB Output Voltage					5VDC
VSB Output Power	CTRL ON	115VAC/230VAC			5W
	CTRL OFF	230VAC 115VAC			5W 1W
Output Voltage Adjustability ⁽⁷⁾	on-board potentiometer				±2VDC
ON/OFF CTRL	CON3, Pin3 (refer to "VSB & CTRL (CON3)")	main and FAN output ON main and FAN output OFF	2.4VDC - 5VDC or open OVDC - 0.8VDC or shorted to GND		
Fan Output Voltage					12VDC
Fan Output Current	@ +50°C (not protected)	continuous peak (1s)		250mA	500mA
Remote Sense ⁽⁸⁾					2VDC
Power OK LED		LED = green LED = red			working failure

Notes:

Note7: By trimming up, decrease output current to avoid exceeding rated output power. By trimming down, do not exceed maximum continuous output current

Note8: The output voltage can be adjusted by both ADJ (potentiometer) and Sense. The maximum combined adjustment range is ±2VDC

REMOTE SENSE

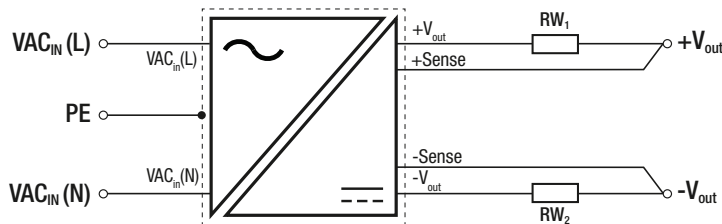

RW₁ ... wire losses +
RW₂ ... wire losses -

PROTECTIONS (Fan output not protected)

Parameter	Type		Value
Input Fuse ⁽⁹⁾	internal		2x T6.3A, slow blow type
Over Voltage Category (OVC)			OVCII
Class of Equipment			Class I
Isolation Voltage (safety certified) ⁽¹⁰⁾	I/P to O/P	1 minute	4kVAC
Isolation Resistance			10MΩ min.
Insulation Grade			reinforced
Leakage Current			0.25mA max.
Means of Protection	250VAC working voltage		2MOPP

Notes:

Note9: Refer to local safety regulations if input over-current protection is also required. Recommended fuse: slow blow type

Note10: For repeat Hi-Pot testing, reduce the time and/or the test voltage

PROTECTIONS MAIN OUTPUT

Short Circuit Protection (SCP)	below 100mΩ	P _{in} =10W max.	hiccup mode, auto recovery
Over Voltage Protection (OVP)			110% - 120%, hiccup mode
Over Current Protection (OCP)			105% - 135%, hiccup mode
Over Temperature Protection (OTP)			auto recovery, internal temperature sensors

Specifications (measured @ Ta= 25°C, rated input, rated load unless otherwise stated)

PROTECTIONS AUX (VSB)

Short Circuit Protection (SCP)	below 100mΩ	hiccup mode, auto recovery
Over Voltage Protection (OVP)		8-9VDC, hiccup mode
Over Current Protection (OCP)		2.5-3.5A, hiccup mode

ENVIRONMENTAL

Parameter	Condition	Value
Operating Temperature Range	refer to below graphs (valid for /OF and /ENC)	-40°C to +70°C
Temperature Coefficient		±0.02%/K
Operating Altitude ⁽¹⁾		5000m
Operating Humidity	non-condensing	20% - 90% RH max.
Pollution Degree		PD2
Shock		250m/s ² , 6ms; 3 times, each along x, y, z axes
Vibration		90-200Hz, 10m/s ² ; 3.5min./1cycle, 5 periods, each along x, y, z axes
MTBF	according to MIL-217F Method 2 Components Stress Method	+25°C (forced air cooling) 200 x 10 ³ hours +45°C (forced air cooling) 50 x 10 ³ hours

Notes:

Note11: Recognized by safety agency for safe operation up to 5000m. High altitude operation may impact the performance and lifetime. Please contact RECOM tech support for advice.

Thermal Derating 115VAC

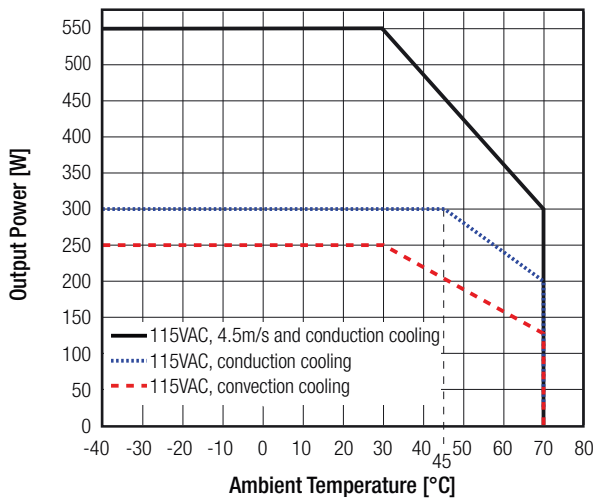

Line Derating (<115VAC)

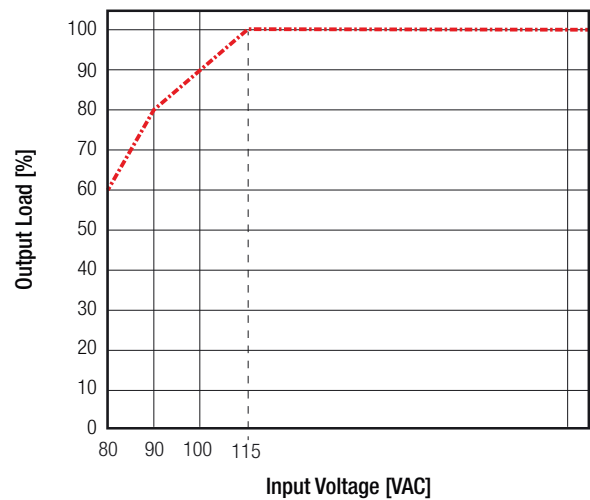

Thermal Derating 230VAC

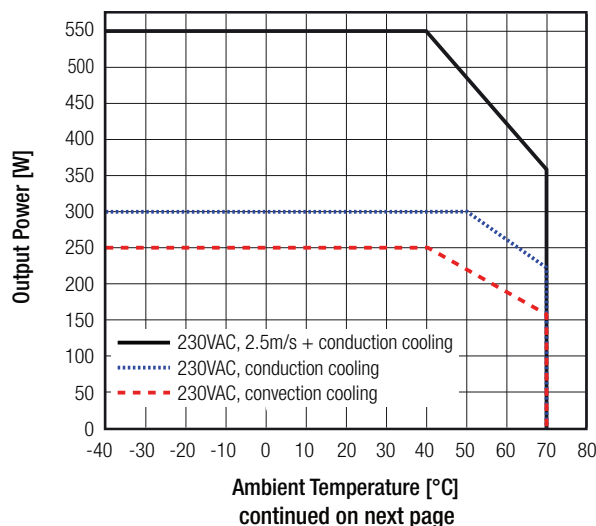

Conduction Cooling:
ground plane ref.: 2mm alloy; size A4

Convection Cooling:
<0.1m/s = still air
0.1 - 0.2m/s = natural convection

Specifications (measured @ Ta= 25°C, rated input, rated load unless otherwise stated)

Peak Load Capability

Calculation

- P_{nom} = nom. output power [W]
- P_p = peak output power (≤550W) [W]
- P_r = recovery output power [W]
- t₁ = peak time set (10s max.) [s]
- t₂ = recovery time (min. 4 x t₁) [s]
- k = safety factor 1.7 []

$$P_r = \frac{P_{nom} \times (t_{1set} + t_2) - (P_p \times t_{1set})}{t_2 \times k}$$

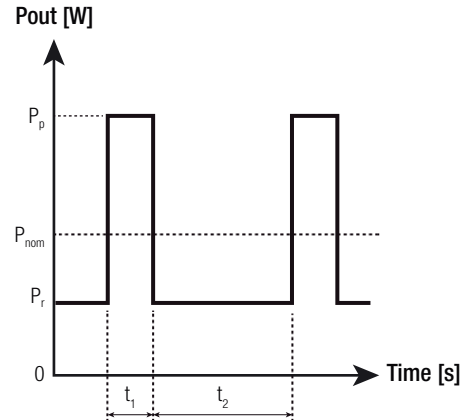

Practical Example (RACM550-24SG/OF):

Take the RACM550-24SG/OF at 100VAC input voltage and T_{AMB} = 60°C (220W) with conduction cooling.

P_{nom.} = refer to derating graphs= 245W with line derating 220W

P_p = 550W

t₁ = 10s

t₂ = 40s

k = 1.7

$$P_r = \frac{220 \times (10 + 40) - (550 \times 10)}{40 \times 1.7} = \underline{\underline{80.9W}}$$

Recommended thermal reference points for specific operating conditions

Top View

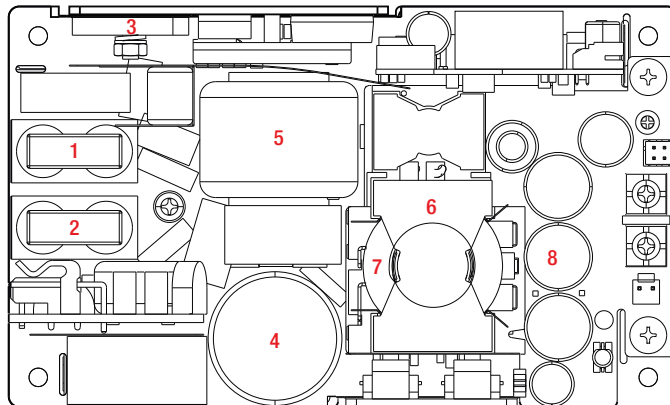

Number	Component	Rated Max. Temperature	Critical by:			
			LL & natural convection	HL & natural convection	LL & forced cooling	HL & forced cooling
1	L3	130	x		x	
2	L4	130	x		x	
3	BD1	125	x		x	
4	C8	105	x	x	x	x
5	L8	130	x	x	x	x
6	T1 (core)	130	x	x		x
7	T1 (wire)	150	x	x		x
8	C27	105	x	x		

Specifications (measured @ Ta= 25°C, rated input, rated load unless otherwise stated)

SAFETY AND CERTIFICATIONS

Certificate Type (Safety)	Report Number	Standard
Audio/video, information and communication technology equipment - Safety requirements (CB)	211-700545-000	IEC62368-1:2014 2nd Edition
Audio/video, information and communication technology equipment - Safety requirements		EN62368-1:2014 + A11:2017
Audio/video, information and communication technology equipment - Safety requirements (TÜV NRTL)	65.250.19.032.02	UL62368-1:2014
		CAN/CSA C22.2 No.62368-1:2014
Information Technology Equipment, General Requirements for Safety (CB)	211-700555-000	IEC60950-1:2005, 2nd Edition + A2:2013
Information Technology Equipment, General Requirements for Safety		EN60950-1:2006 + A2:2013
Household and similar electrical appliances - Safety - Part 1: General requirements	SA1904214L 02001	EN60335-1:2012 + A11:2014
Measurement methods for electromagnetic fields of household appliances and similar apparatus with regard to human exposure		EN62233:2008
Medical Electric Equipment, General Requirements for Safety and Essential Performance	E314885-D1001- 1-A0-C0-UL	ANSI/AAMI ES60601-1:2005 + A2:2010/(R)2012
		CAN/CSA-C22.2 No. 60601-1:14, 3rd Ed.
Medical Electric Equipment, General Requirements for Safety and Essential Performance (CB)	E314885-D1005- 1-A0-C0-CB	IEC60601-1:2005, 3rd Edition + AM1:2012
Medical Electric Equipment, General Requirements for Safety and Essential Performance		EN60601-1:2006 + A1:2013
Safety of power transformers, power supplies, reactors and similar products - Part 1: General requirements and tests (CB)	211-700556-000	IEC61558-1:2005 2nd Edition + A1:2009
Safety of transformers, reactors, power supply units and similar products for supply voltages up to 1100 V - Part 2-16: Particular requirements and tests for switch mode power supply units and transformers for switch mode power supply units (CB)		IEC61558-2-16:2009 1st Edition + A1:2013
Safety of power transformers, power supplies, reactors and similar products - Part 1: General requirements and tests (LVD)		EN61558-1:2005 + A1:2009
Safety of transformers, reactors, power supply units and similar products for supply voltages up to 1100 V - Part 2-16: Particular requirements and tests for switch mode power supply units and transformers for switch mode power supply units (LVD)		EN61558-2-16:2009 + A1:2013
RoHS2		RoHS 2011/65/EU + AM2015/863

EMC Compliance (according to EN55032)	Condition	Standard / Criterion
Electromagnetic compatibility of multimedia equipment - Emission requirements	with floating output ⁽¹²⁾	EN55032:2015, Class B
Electromagnetic compatibility of multimedia equipment - Immunity requirements		EN55035:2017
Information technology equipment - Immunity characteristics - Limits and methods of measurement		EN55024:2010 + A1:2015
ESD Electrostatic discharge immunity test	Air ±8kV, Contact ±4kV	EN61000-4-2:2009, Criteria A
Radiated, radio-frequency, electromagnetic field immunity test	3V/m (80-1000MHz, 1800MHz, 2600MHz, 3500MHz, 5000MHz)	EN61000-4-3:2006+A2:2010, Criteria A
Fast Transient and Burst Immunity	AC Power Port= L-N: 1kV	EN61000-4-4:2012, Criteria A
Surge Immunity	AC Power Port= L-N, L-PE, N-PE: 1kV	EN61000-4-5:2014, Criteria B
Immunity to conducted disturbances, induced by radio-frequency fields	AC Power Port: 3V (0.15-80MHz)	EN61000-4-6:2014, Criteria A
Power Magnetic Field Immunity	1A/m	EN61000-4-8:2010, Criteria A
Voltage Dips	>95% at 50/60Hz	EN61000-4-11:2004, Criteria A
	30% at 50Hz	EN61000-4-11:2004, Criteria A
	30% at 60Hz	EN61000-4-11:2004, Criteria B
Voltage Interruptions	>95% at 50Hz	EN61000-4-11:2004, Criteria C
	>95% at 60Hz	EN61000-4-11:2004, Criteria B
Limits of Harmonic Current Emissions	Class A	EN61000-3-2:2014
Limits of Voltage Fluctuations & Flicker	Clause 5	EN61000-3-3:2013

Notes:

Note12: For improved radiated emission performance wrap two turns of the output cable onto a clamp filter (e.g. Würth 742 712 21)

continued on next page

Specifications (measured @ Ta= 25°C, rated input, rated load unless otherwise stated)

EMC Compliance (according to EN60601-1-2)	Condition	Standard / Criterion
Medical electrical equipment Part 1-2: General requirements for basic safety and essential performance – Collateral Standard: Electromagnetic disturbances – Requirements and tests		EN60601-1-2:2015, Class B
ESD Electrostatic discharge immunity test	Contact ±2, 4, 6, 8kV	EN61000-4-2:2009
Radiated, radio-frequency, electromagnetic field immunity test	10V/m (80-2700MHz) 27V/m (385MHz) 28V/m (450, 810, 870, 930, 1720, 1845, 1970, 2450MHz) 9V/m (710, 745, 780, 5240, 5500, 5785MHz)	EN61000-4-3:2006+A2:2010
Fast Transient and Burst Immunity	AC Power Port= L-N, PE: 2kV	EN61000-4-4:2012
Surge Immunity	AC Power Port= L-N: 0.5, 1kV L-PE, N-PE: 0.5, 1, 2kV	EN61000-4-5:2014
Immunity to conducted disturbances, induced by radio-frequency fields	AC Power Port: 3, 6Vrms (0.15-80MHz)	EN61000-4-6:2014
Power Magnetic Field Immunity	30A/m	EN61000-4-8:2010
Voltage Dips	>95% (0.5P, 1P)	EN61000-4-11:2004
	30% (25P)	
Voltage Interruptions	>95% (250P)	

DIMENSION AND PHYSICAL CHARACTERISTICS

Parameter	Type	Value
Material	PCB baseplate / case ("ENC")	FR4, (UL94 V-0) aluminum
Dimension (LxWxH)	open frame version enclosed version	127.0 x 76.0 x 38.0mm 150.0 x 87.0 x 45.0mm
Weight	open frame version enclosed version	500g typ. 590g typ.

Dimension Drawing Open Frame (mm)

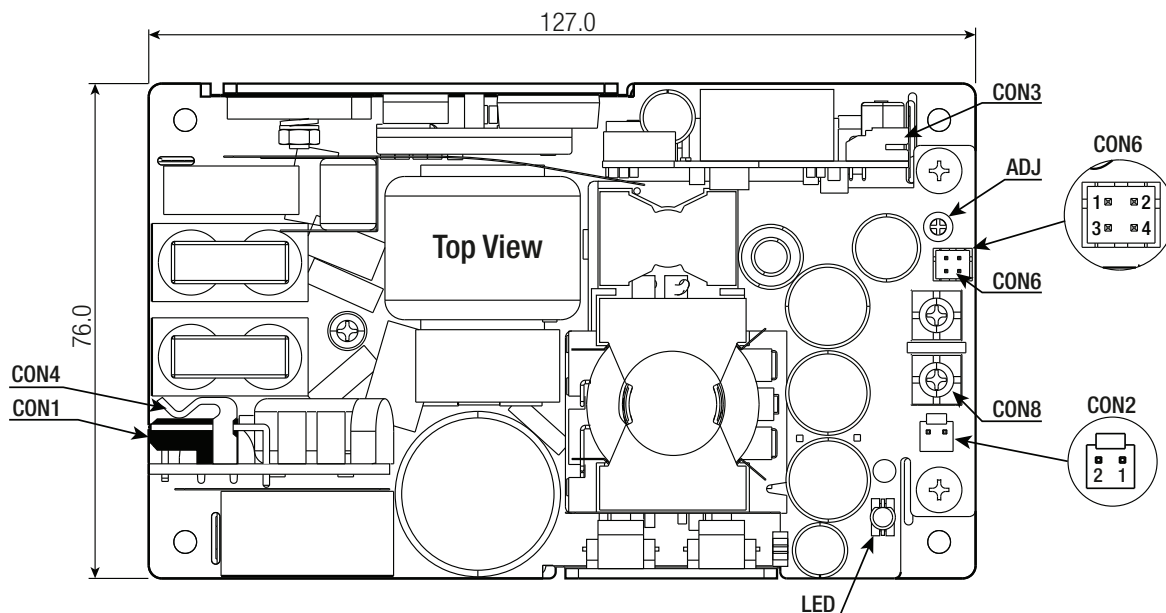

continued on next page

Specifications (measured @ Ta= 25°C, rated input, rated load unless otherwise stated)

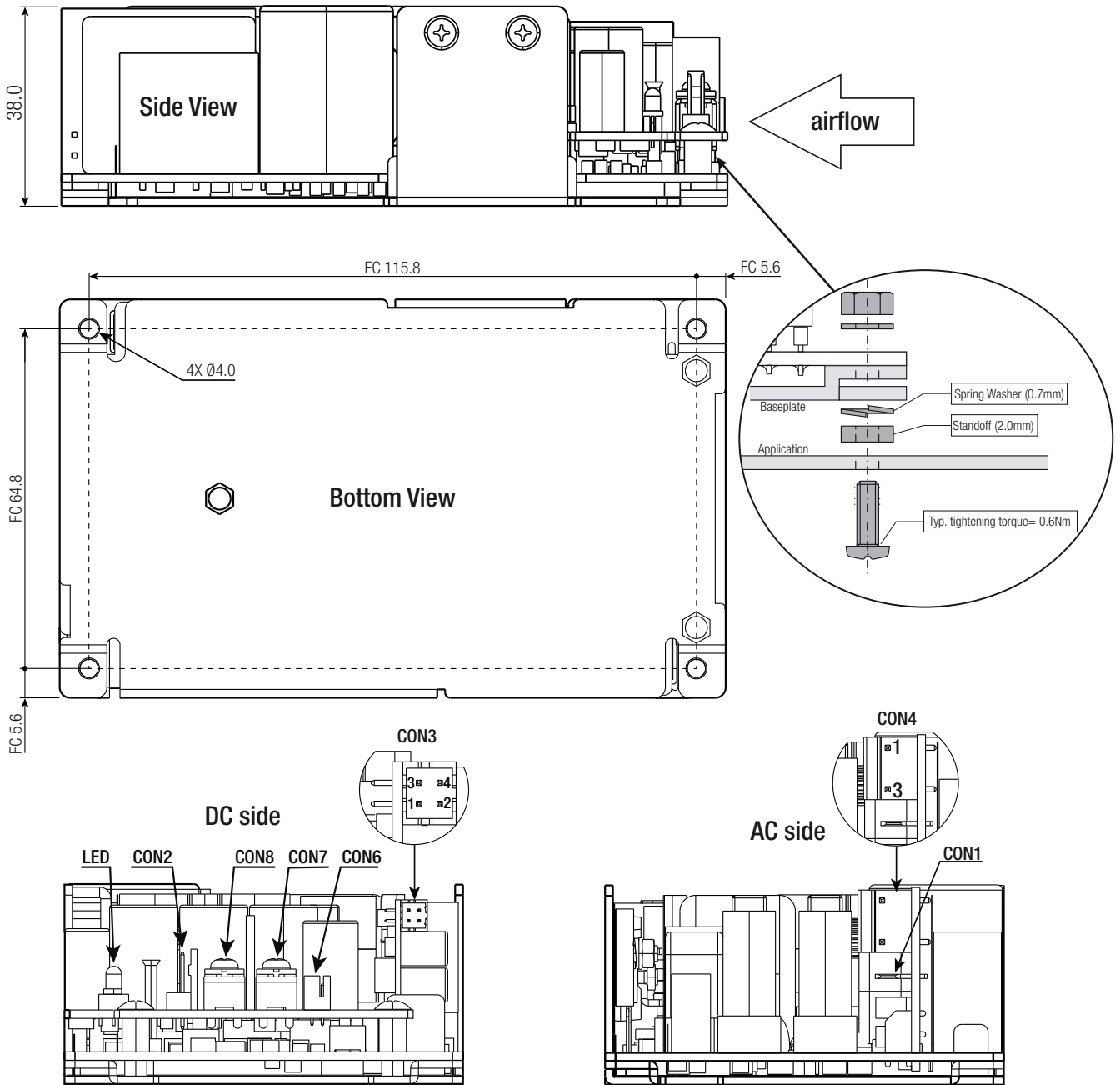

Compatible Connector (valid for open frame and enclosed version)

PE (CON1)			AC Input (CON4)			FAN (CON2)			VSB & CTRL (CON3)			Sense (CON6)		
#	Function	Connector	#	Function	Mating Housing	#	Function	Mating Housing	#	Function	Mating Housing	#	Function	Mating Housing
1	PE	TE Connectivity PIDG series with positive lock .250EX	1	AC/N	Molex 09-50-1031 or similar	1	-FAN	Molex 22-01-1022	1	+5VSB	R-L2001D-Y-2x2P	1	-Sense	R-L2001D-Y-2x2P
			2	no pin		2	+FAN		2,4	GND		2,4	NC	
			3	AC/L					3	PS ON		3	+Sense	

NC= No connection

MAIN Output Screw Terminal (CON7/8)

#	Function	AWG
CON7	-Vout	14-26
CON8	+Vout	14-26

wire stripping length: 5.0mm
recommended tightening torque: 0.8Nm

Notes:

Note12: For other mating connectors, please contact RECOM_tech_support for advice

Maximum tightening torque for mounting without standoffs: 0.3Nm
FC= fixing centers
Tolerance: ISO-2768-M (unless otherwise stated)

continued on next page

Specifications (measured @ Ta= 25°C, rated input, rated load unless otherwise stated)

Dimension Drawing Enclosed Version (mm)

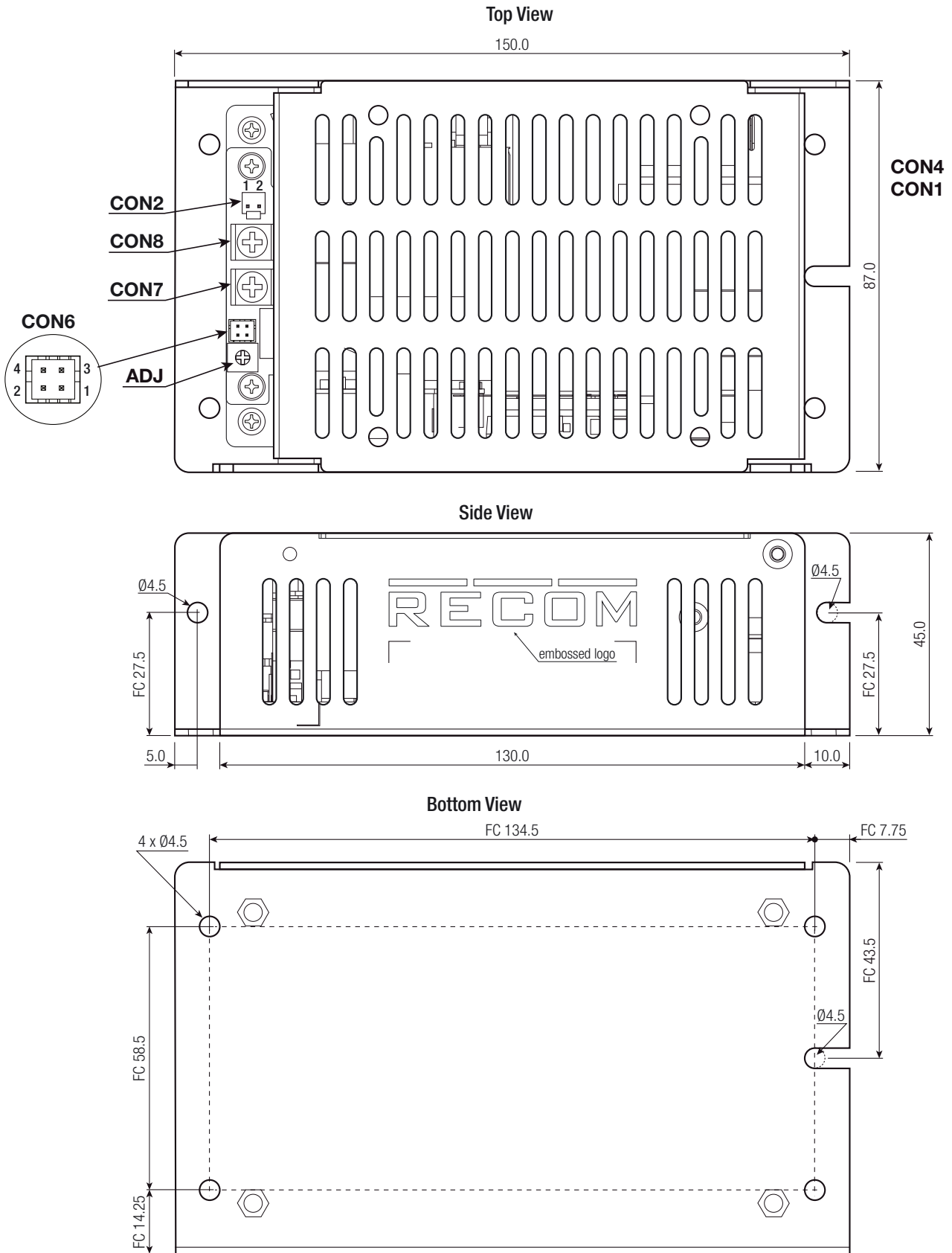

continued on next page

Specifications (measured @ Ta= 25°C, rated input, rated load unless otherwise stated)

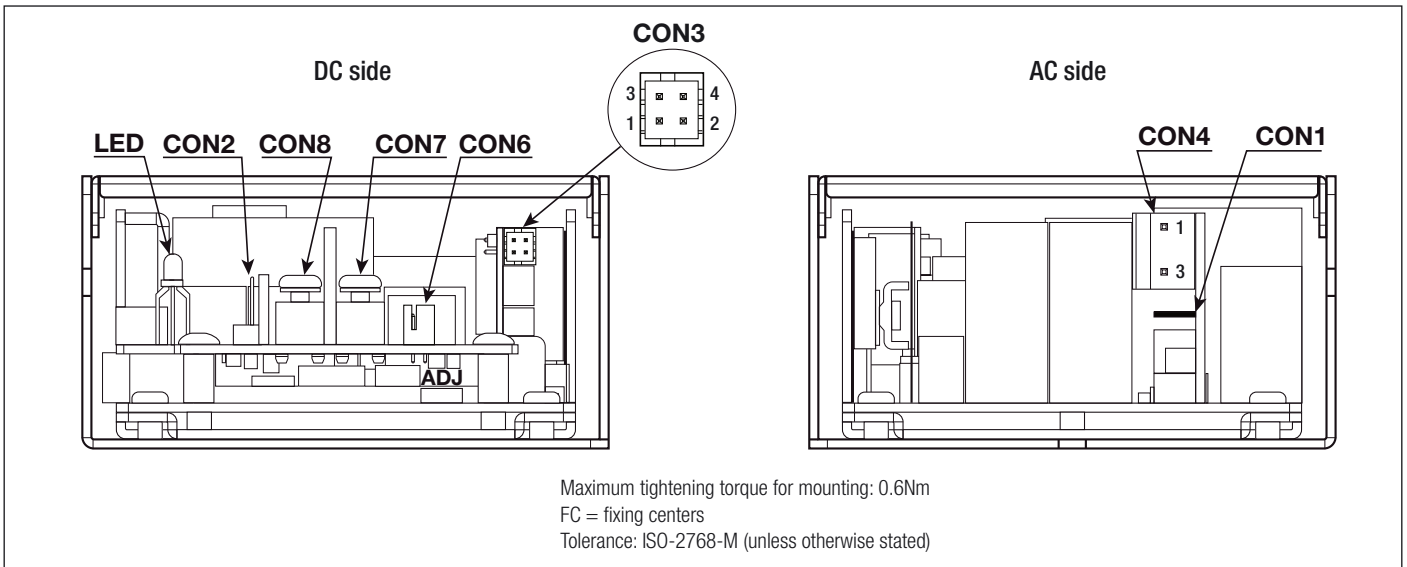

INSTALLATION AND APPLICATION

Mounting Direction

Forced air conditions as specified are valid for indicated airflow direction only!

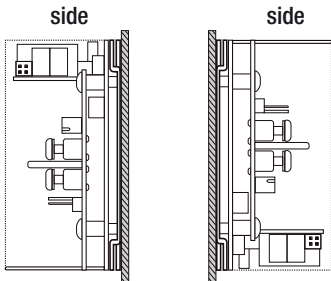
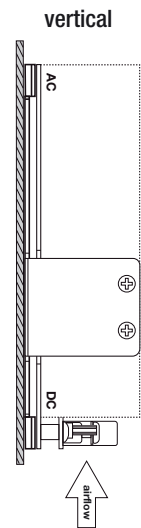
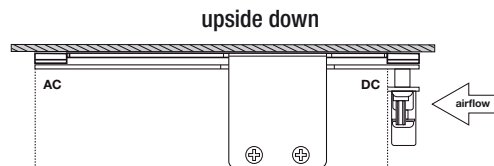
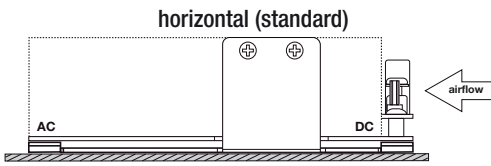

If module is horizontal or side mounted no derating is required.
 If module is mounted vertically or upside down with natural convection cooling, the power must be derated at least 10%.
 For convection cooling, ensure sufficient distance to adjacent components!
 With forced air cooling, mounting orientation has no impact on output power.
 Device should be fan cooled from DC side.
 If thermal conduction cooling is suggested, use of heat sink compound is recommended for improved heat transfer via baseplate.

Block Diagram

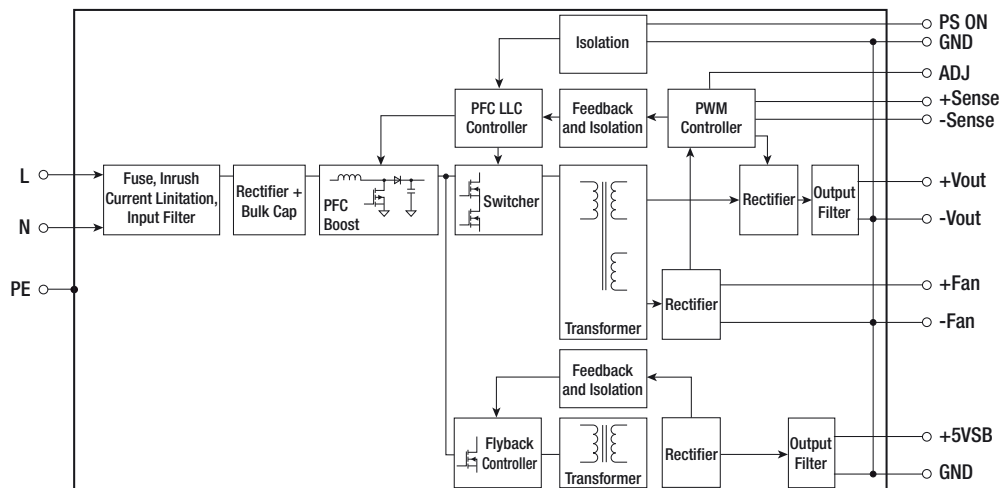

For improved radiated emission performance wrap two turns of the output cable onto a clamp filter (e.g. Würth 742 712 21)

Specifications (measured @ Ta= 25°C, rated input, rated load unless otherwise stated)

PACKAGING INFORMATION			
Parameter	Type		Value
Packaging Dimension (LxWxH)	cardboard box	open frame version	142.0 x 128.0 x 58.0mm
		enclosed version	192.0 x 142.0 x 58.0mm
Packaging Quantity			1 pcs
Storage Temperature Range			-55°C to +85°C
Storage Humidity	non-condensing		95% RH max.

The product information and specifications may be subject to changes even without prior written notice. The product has been designed for various applications; its suitability lies in the responsibility of each customer. The products are not authorized for use in safety-critical applications without RECOM's explicit written consent. A safety-critical application is an application where a failure may reasonably be expected to endanger or cause loss of life, inflict bodily harm or damage property. The applicant shall indemnify and hold harmless RECOM, its affiliated companies and its representatives against any damage claims in connection with the unauthorized use of RECOM products in such safety-critical applications.