

Sample set - SAMPLE DMC 0,5/ 5-G1-2,54 THR - 1859521

Please be informed that the data shown in this PDF Document is generated from our Online Catalog. Please find the complete data in the user's documentation. Our General Terms of Use for Downloads are valid (<http://phoenixcontact.com/download>)

PCB headers, nominal current: 6 A, rated voltage (III/2): 160 V, number of positions: 5, pitch: 2.54 mm, color: black, contact surface: Gold, mounting: THR soldering



The figure shows a 10-pos. version with 20 contacts

Your advantages

- ✓ Gold-plated contacts ensure transfer quality remains stable over the long term
- ✓ Designed for integration into the SMT soldering process
- ✓ Conductor connection on several levels enables higher contact density
- ✓ Small component size for applications where space is at a premium
- ✓ Supplied in tape-on-reel packing according to IEC 60286-3 for automated mounting

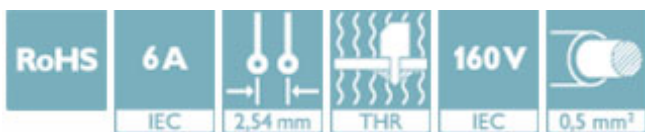

Key Commercial Data

Packing unit	1
GTIN	
GTIN	4055626111926
Custom tariff number	85366930

Technical data

Dimensions

Length [l]	9.64 mm
Width	13.2 mm
Pitch	2.54 mm
Dimension a	10.16 mm
Width [w]	13.2 mm
Height [h]	7.39 mm
Length of the solder pin	2 mm
Pin dimensions	0.64 x 0.64 mm
Pin spacing	2.54 mm

Sample set - SAMPLE DMC 0,5/ 5-G1-2,54 THR - 1859521

Technical data

Dimensions

Length	9.64 mm
--------	---------

General

Range of articles	DMC 0,5/...G1-THR
Insulating material group	IIIa
Rated surge voltage (III/3)	2.5 kV
Rated surge voltage (III/2)	2.5 kV
Rated surge voltage (II/2)	2.5 kV
Rated voltage (III/3)	32 V
Rated voltage (III/2)	160 V
Rated voltage (II/2)	160 V
Connection in acc. with standard	EN-VDE
Nominal current I_N	6 A
Insulating material	LCP
Flammability rating according to UL 94	V0
Color	black
Number of positions	5

Standards and Regulations

Connection in acc. with standard	EN-VDE
Flammability rating according to UL 94	V0

Environmental Product Compliance

China RoHS	Environmentally friendly use period: unlimited = EFUP-e
	No hazardous substances above threshold values

Drawings

Drilling diagram

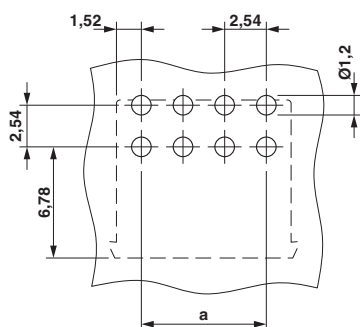

Dimensional drawing

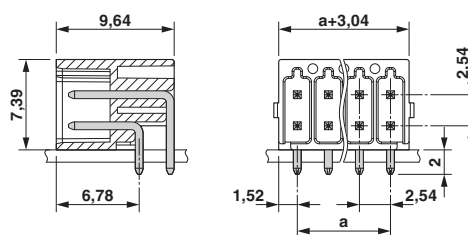

Classifications

eCl@ss

eCl@ss 5.1	27260700
------------	----------

Sample set - SAMPLE DMC 0,5/ 5-G1-2,54 THR - 1859521

Classifications

eCl@ss

eCl@ss 6.0	27260700
eCl@ss 7.0	27440402
eCl@ss 8.0	27440402
eCl@ss 9.0	27440402

ETIM

ETIM 5.0	EC002637
ETIM 6.0	EC002637

UNSPSC

UNSPSC 13.2	39121409
-------------	----------

Approvals

Approvals

Approvals

EAC

Ex Approvals

Approval details

EAC		B.01742
-----	--	---------

Accessories

Accessories

Labeled terminal marker

Marker card - SK 2,54/2,8:FORTL.ZAHLEN - 0804853



Marker card, Card, white, labeled, Horizontal: consecutive numbers 1 ... 10, 11 ... 20, etc. up to 91 ... 99, mounting type: adhesive, for terminal block width: 2.54 mm, lettering field size: 2.54 x 2.8 mm

Additional products

Sample set - SAMPLE DMC 0,5/ 5-G1-2,54 THR - 1859521

Accessories

Printed-circuit board connector - DFMC 0,5/ 5-ST-2,54 - 1844604

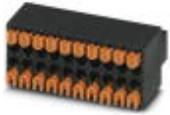

Plug, nominal current: 6 A, rated voltage (III/2): 160 V, number of positions: 5 with 10 contacts, pitch: 2.54 mm, connection method: spring connection, color: black, contact surface: gold

Phoenix Contact 2019 © - all rights reserved
<http://www.phoenixcontact.com>