

## Base strip - PTSM 0,5/ 3-HV-2,5-THR R32 - 1778560

Please be informed that the data shown in this PDF Document is generated from our Online Catalog. Please find the complete data in the user's documentation. Our General Terms of Use for Downloads are valid (<http://phoenixcontact.com/download>)



Header, Nominal current: 6 A, Rated voltage (III/2): 160 V, Number of positions: 3, Pitch: 2.5 mm, Color: black, Contact surface: Tin, Mounting: THR soldering

### Why buy this product

- ✓ Designed for integration into the SMT soldering process
- ✓ Supplied in tape-on-reel packing according to IEC 60286-3 for automated mounting
- ✓ Vertical connection enables multi-row arrangement on the PCB



### Key Commercial Data

Packing unit	1 STK
Minimum order quantity	330 STK
GTIN	 4 046356 529730
GTIN	4046356529730
Weight per Piece (excluding packing)	1.880 g
Custom tariff number	85366930
Country of origin	India

### Technical data

#### Dimensions

Length	5 mm
Pitch	2.5 mm
Dimension a	5.00 mm
Width	9.20 mm
Constructional height	7.5 mm
Height	9.5 mm

## Base strip - PTSM 0,5/ 3-HV-2,5-THR R32 - 1778560

### Technical data

#### Dimensions

Length of the solder pin	2 mm
Pin dimensions	0,6 x 0,6 mm
Pin spacing	2.50 mm
Hole diameter	1.1 mm

#### General

Range of articles	PTSM 0,5/..-HV-THR
Insulating material group	IIIa
Rated surge voltage (III/3)	2.5 kV
Rated surge voltage (III/2)	2.5 kV
Rated surge voltage (II/2)	2.5 kV
Rated voltage (III/3)	50 V 50 V
Rated voltage (III/2)	160 V
Rated voltage (II/2)	160 V
Connection in acc. with standard	EN-VDE
Nominal current I <sub>N</sub>	6 A
Maximum load current	6 A
Insulating material	LCP
Flammability rating according to UL 94	V0
Color	black
Number of positions	3

#### Standards and Regulations

Connection in acc. with standard	EN-VDE
	UL
Flammability rating according to UL 94	V0

#### Environmental Product Compliance

China RoHS	Environmentally friendly use period: unlimited = EFUP-e
	No hazardous substances above threshold values

### Drawings

# Base strip - PTSM 0,5/ 3-HV-2,5-THR R32 - 1778560

Drilling diagram

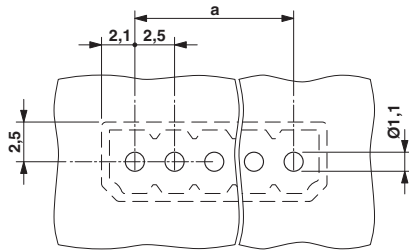

Diagram

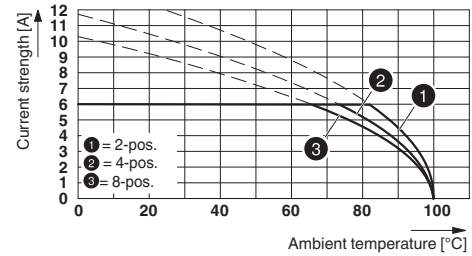

Derating curve for: PTSM 0,5/...-P-2,5 with PTSM 0,5/...-HV-2,5-THR R...

Dimensional drawing

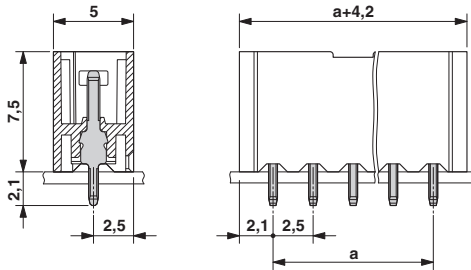

Dimensional drawing

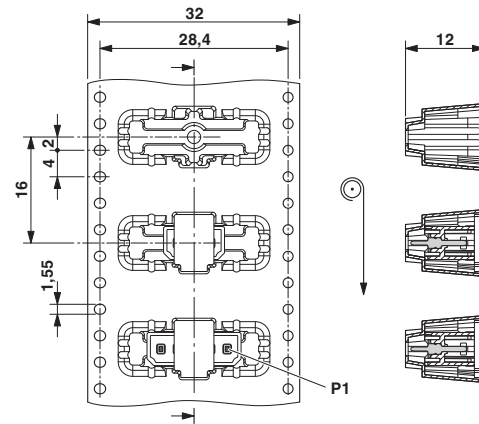

## Approvals

Approvals

Approvals

UL Recognized / UL Recognized / EAC / cULus Recognized

Ex Approvals

Approval details

## Base strip - PTSM 0,5/ 3-HV-2,5-THR R32 - 1778560

### Approvals

UL Recognized		<a href="http://database.ul.com/cgi-bin/XYV/template/LISEXT/1FRAME/index.htm">http://database.ul.com/cgi-bin/XYV/template/LISEXT/1FRAME/index.htm</a>	FILE E 60425
---------------	---	---	--------------

UL Recognized		<a href="http://database.ul.com/cgi-bin/XYV/template/LISEXT/1FRAME/index.htm">http://database.ul.com/cgi-bin/XYV/template/LISEXT/1FRAME/index.htm</a>	FILE E 118976
		B	
Nominal current IN		5 A	
Nominal voltage UN		150 V	

EAC			B.01742
-----	---	--	---------

cULus Recognized		<a href="http://database.ul.com/cgi-bin/XYV/template/LISEXT/1FRAME/index.htm">http://database.ul.com/cgi-bin/XYV/template/LISEXT/1FRAME/index.htm</a>	FILE E 60425
------------------	---	---	--------------