

## GMSTBV 2,5/ 7-GF-7,62

Order No.: 1829206

The figure shows a 10-position version of the product

<http://eshop.phoenixcontact.de/phoenix/treeViewClick.do?UID=1829206>Header, Nominal current: 12 A, Nom. voltage: 400 V, Pitch: 7.62 mm,  
Number of positions: 7, Assembly: Soldering

### Commercial data

EAN	4017918050962
Pack	50 pcs.
Customs tariff	85366990
Weight/Piece	0.00584 KG
Catalog page information	Page 277 (CC-2009)

### Product notes

WEEE/RoHS-compliant since:  
01/01/2003

<http://www.download.phoenixcontact.com>  
Please note that the data given here has been taken from the online catalog. For comprehensive information and data, please refer to the user documentation. The General Terms and Conditions of Use apply to Internet downloads.

### Technical data

#### Dimensions / positions

Length	8.6 mm
Pitch	7.62 mm
Dimension a	45.72 mm
Number of positions	7
Pin dimensions	1 x 1 mm

Hole diameter	1.4 mm
<b>Technical data</b>	
Insulating material group	IIIa
Rated surge voltage (III/3)	6 kV
Rated surge voltage (III/2)	6 kV
Rated surge voltage (II/2)	6 kV
Rated voltage (III/2)	630 V
Rated voltage (II/2)	630 V
Connection in acc. with standard	EN-VDE
Nominal current $I_N$	12 A
Nominal voltage $U_N$	400 V
Maximum load current	12 A
Insulating material	PA
Inflammability class acc. to UL 94	V0

#### Accessories

Item	Designation	Description
<b>Assembly</b>		
1755477	MSTB-BL	Keying cap, for forming sections, plugs onto header pin, green insulating material
<b>Marking</b>		
0804549	SK 7,62/3,8:FORTL.ZAHLEN	Marker card, printed horizontally, self-adhesive, 10-section marker strip, 12 identical decades marked 1-10, 11-20 etc. up to 91-99, sufficient for 120 terminal blocks
<b>Plug/Adapter</b>		
1734401	CR-MSTB	Coding section, inserted into the recess in the header or the inverted plug, red insulating material

## Drawings

Drilling diagram

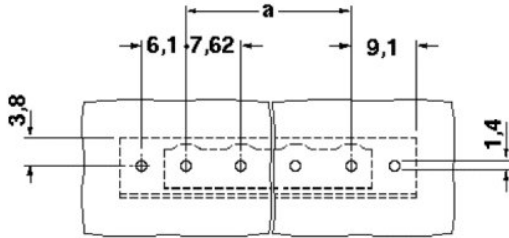

Dimensioned drawing

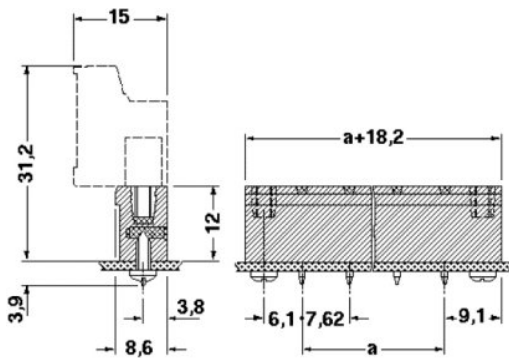

**Address**

PHOENIX CONTACT GmbH & Co. KG  
Flachsmarktstr. 8  
32825 Blomberg, Germany  
Phone +49 5235 3 00  
Fax +49 5235 3 41200  
<http://www.phoenixcontact.com>



© 2009 Phoenix Contact  
Technical modifications reserved;