

# Printed-circuit board connector - DMCV 1,5/ 6-G1F-3,5-LR P26THR - 1874195

Please be informed that the data shown in this PDF Document is generated from our Online Catalog. Please find the complete data in the user's documentation. Our General Terms of Use for Downloads are valid (<http://phoenixcontact.com/download>)

PCB headers, nominal current: 8 A, rated voltage (III/2): 160 V, number of positions: 6, pitch: 3.5 mm, color: black, contact surface: Tin, mounting: THR soldering



## Your advantages

- ✓ Designed for integration into the SMT soldering process
- ✓ Vertical connection enables multi-row arrangement on the PCB
- ✓ Screwable flange for superior mechanical stability
- ✓ Automatic locking and intuitive release through Lock and Release operating lever in contrasting color
- ✓ Small component size for applications where space is at a premium

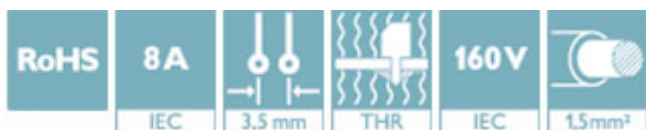

## Key Commercial Data

Packing unit	50 pc
Minimum order quantity	50 pc
GTIN	 4 055626 259475
GTIN	4055626259475
Weight per Piece (excluding packing)	3.300 g
Custom tariff number	85366930
Country of origin	Germany

## Technical data

### Dimensions

Length [ l ]	10.6 mm
Width	28 mm
Pitch	3.5 mm
Dimension a	17.5 mm
Width [ w ]	28 mm
Height [ h ]	12.6 mm

# Printed-circuit board connector - DMCV 1,5/ 6-G1F-3,5-LR P26THR - 1874195

## Technical data

### Dimensions

Height	10 mm
Length of the solder pin	2.6 mm
Pin dimensions	0.8 x 0.8 mm
Pin spacing	5.50 mm
Length	10.6 mm

### General

Range of articles	DMCV 1,5/...G1F-THR
Insulating material group	IIIa
Rated voltage (III/2)	160 V
Nominal current $I_N$	8 A
Flammability rating according to UL 94	V0
Color	black
Number of positions	6

### Standards and Regulations

Flammability rating according to UL 94	V0
--	----

### Environmental Product Compliance

China RoHS	Environmentally friendly use period: unlimited = EFUP-e
	No hazardous substances above threshold values

## Drawings

Schematic diagram

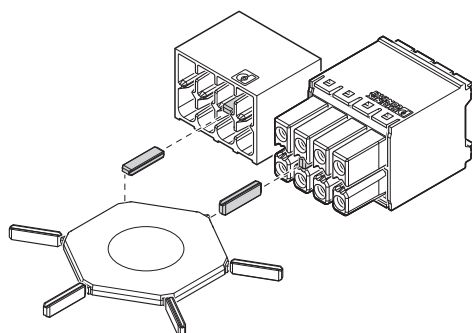

Drilling diagram

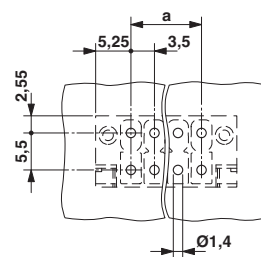

## Classifications

eCl@ss

eCl@ss 4.0	272607xx
eCl@ss 4.1	27260701
eCl@ss 5.0	27260701
eCl@ss 5.1	27260700

# Printed-circuit board connector - DMCV 1,5/ 6-G1F-3,5-LR P26THR - 1874195

## Classifications

### eCl@ss

eCl@ss 6.0	27260700
eCl@ss 7.0	27440402
eCl@ss 8.0	27440402
eCl@ss 9.0	27440402

### ETIM

ETIM 4.0	EC002637
ETIM 5.0	EC002637
ETIM 6.0	EC002637

### UNSPSC

UNSPSC 6.01	30211810
UNSPSC 7.0901	39121409
UNSPSC 11	39121409
UNSPSC 12.01	39121409
UNSPSC 13.2	39121409

## Approvals

### Approvals

#### Approvals

IECEE CB Scheme / VDE Gutachten mit Fertigungsüberwachung / EAC / cULus Recognized

#### Ex Approvals

### Approval details

IECEE CB Scheme		<a href="http://www.iecee.org/">http://www.iecee.org/</a>	DE1-60359_B1_B2
Nominal voltage UN	160 V		
Nominal current IN	8 A		

# Printed-circuit board connector - DMCV 1,5/ 6-G1F-3,5-LR P26THR - 1874195

## Approvals

VDE Gutachten mit Fertigungsüberwachung		<a href="http://www2.vde.com/de/Institut/Online-Service/VDE-gepruefteProdukte/Seiten/Online-Suche.aspx">http://www2.vde.com/de/Institut/Online-Service/ VDE-gepruefteProdukte/Seiten/Online-Suche.aspx</a>	40038423
Nominal voltage UN		160 V	
Nominal current IN		8 A	

EAC		B.01742
-----	---	---------

cULus Recognized		<a href="http://database.ul.com/cgi-bin/XYV/template/LISEXT/1FRAME/index.htm">http://database.ul.com/cgi-bin/XYV/template/LISEXT/1FRAME/index.htm</a>	E60425-20110128
	D	B	C
Nominal voltage UN	300 V	300 V	50 V
Nominal current IN	8 A	8 A	8 A