

# External Iridium Antenna



AEARBD040038-S1621



40.5 x 38.0 x 12.3 mm  
RoHS/RoHS II Compliant  
MSL = N/A

## Features

- Iridium 1616 - 1626.5 MHz
- Low VSWR of 1.5
- RHCP polarization
- Easy to install
- Magnetic mounting

## Applications

- Iridium applications
- IoT
- Handheld devices
- Satellite telephony
- Tracking
- Fleet and asset monitoring

## Electrical Specifications

Parameters	Min.	Typ.	Max.	Units	Note
Frequency Range		1616 ~ 1626.5		MHz	
Center Frequency		1621.25 ± 5.25		MHz	
Bandwidth	15			MHz	
VSWR			1.5		@ CF
Polarization	RHCP				Right Hand Circular Polarization
Impedance		50		Ω	
Gain			0.46	dBi	@ 1621 MHz
Cable Length and Connector	RG174/ 1.2M/ SMA				

## Environmental Characteristics

Parameters	Description
Termination	Ag (Pb free)
Operating Temperature	-30°C to +80°C
Storage Temperature	-40°C to +105°C
Feed Pin Temperature	+290°C for 3 sec
Relative Humidity	40 ~ 95 %

# External Iridium Antenna



AEARBD040038-S1621



40.5 x 38.0 x 12.3 mm  
RoHS/RoHS II Compliant  
MSL = N/A

## Dimensions

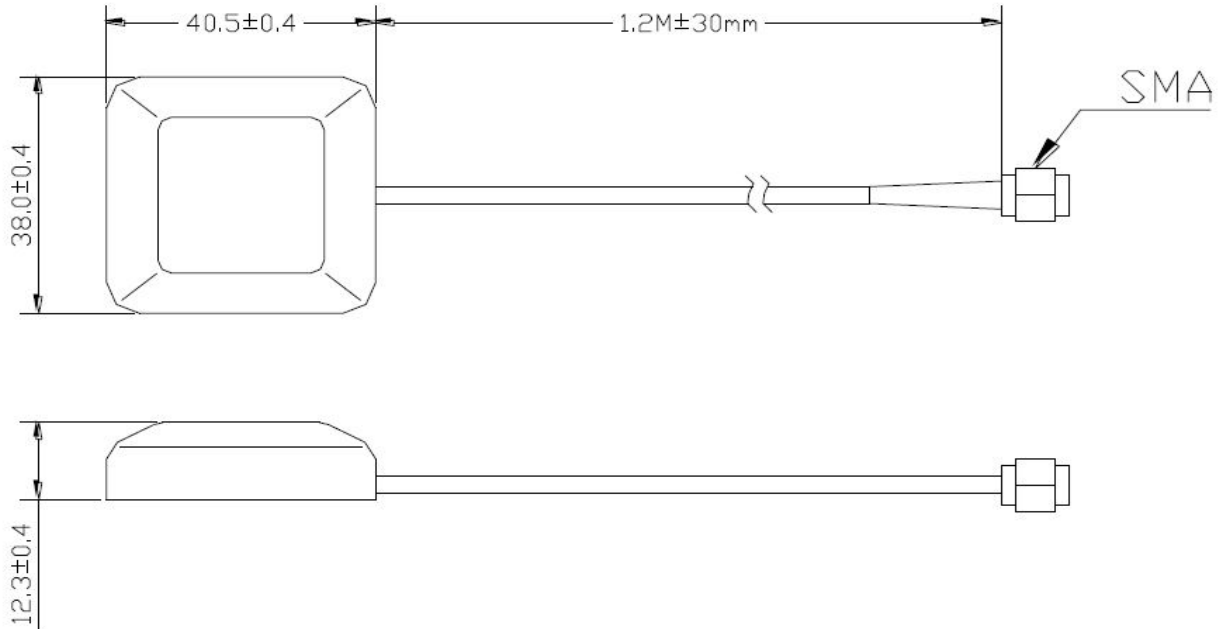

Unit: mm

## Return Loss

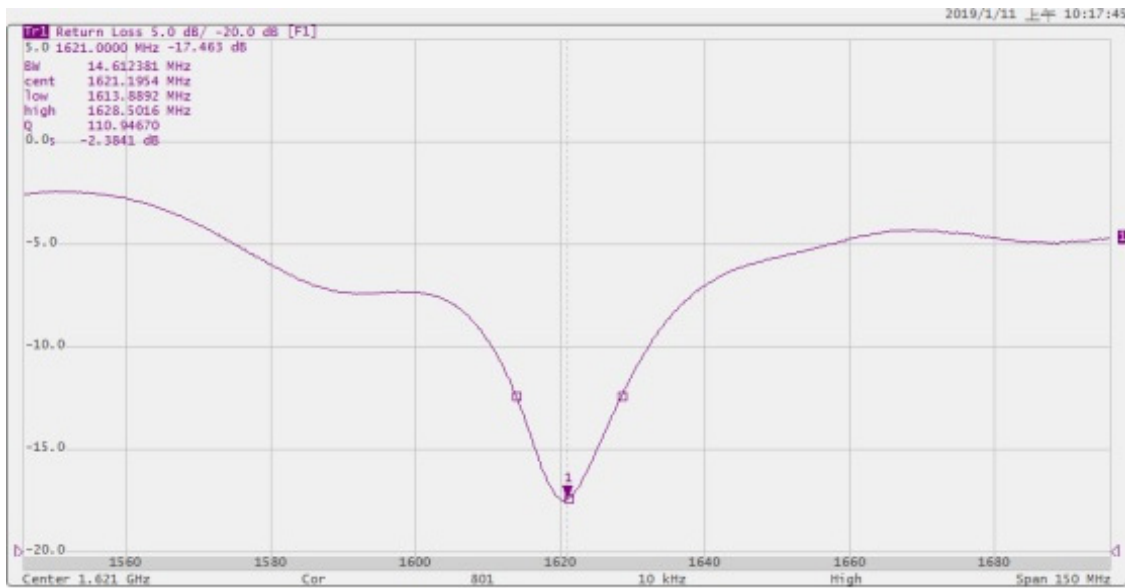

# External Iridium Antenna



AEARBD040038-S1621



40.5 x 38.0 x 12.3 mm  
RoHS/RoHS II Compliant  
MSL = N/A

## SWR

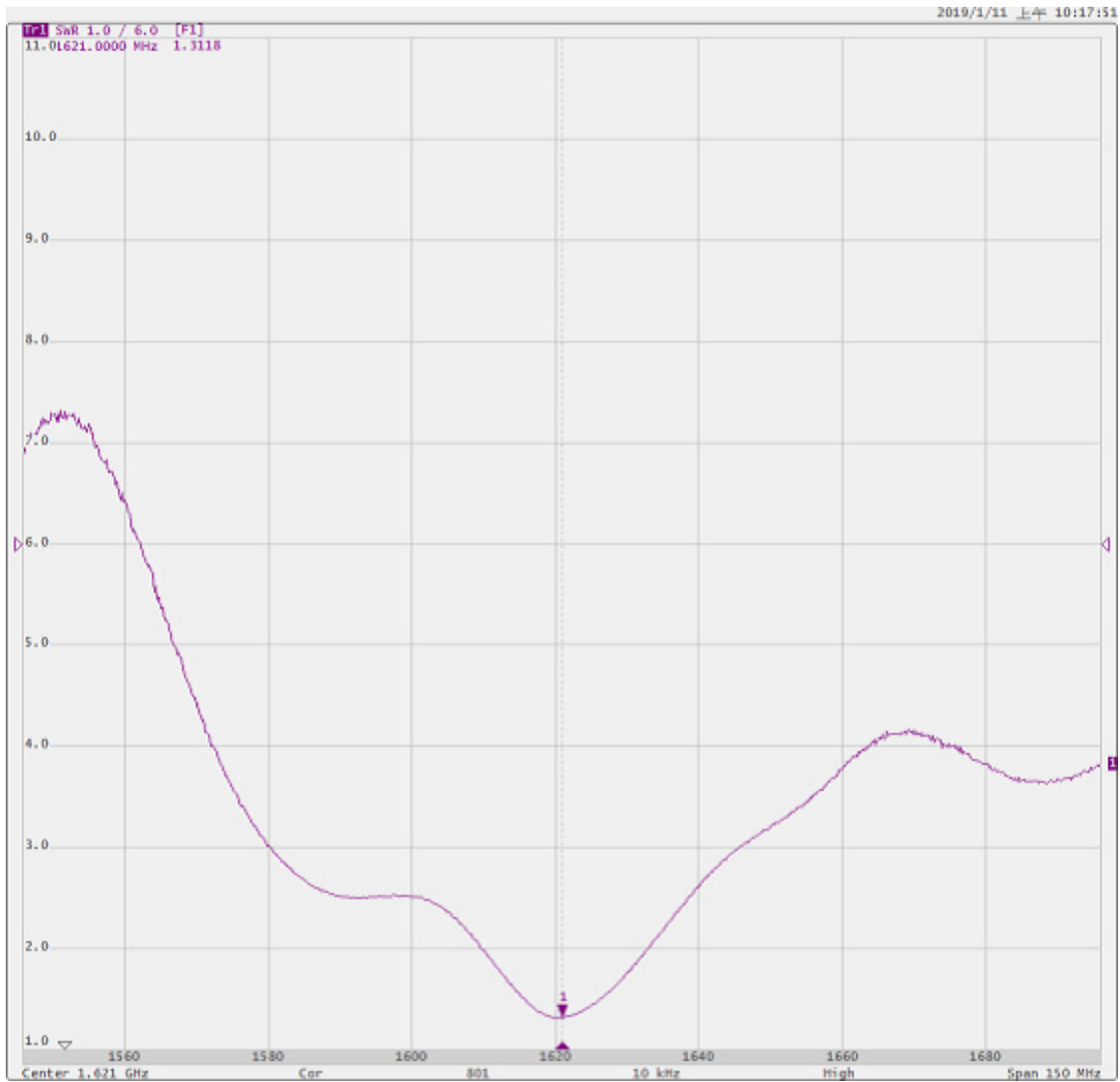

# External Iridium Antenna



AEARBD040038-S1621



40.5 x 38.0 x 12.3 mm  
RoHS/RoHS II Compliant  
MSL = N/A

## Impedance Characteristics

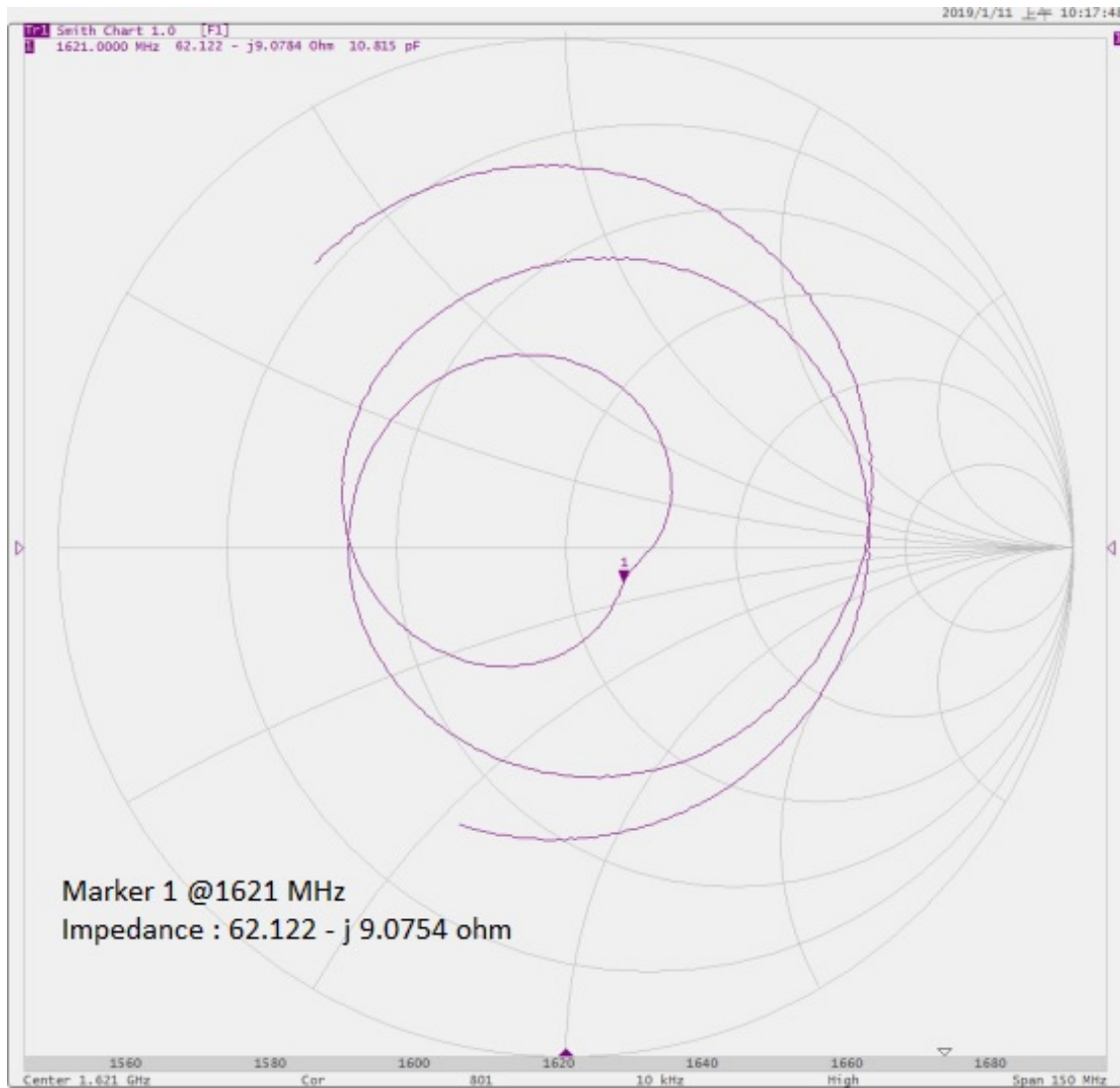

# External Iridium Antenna



AEARBD040038-S1621



40.5 x 38.0 x 12.3 mm  
RoHS/RoHS II Compliant  
MSL = N/A

## Return Loss and Impedance Characteristics (as measured on the test fixture)

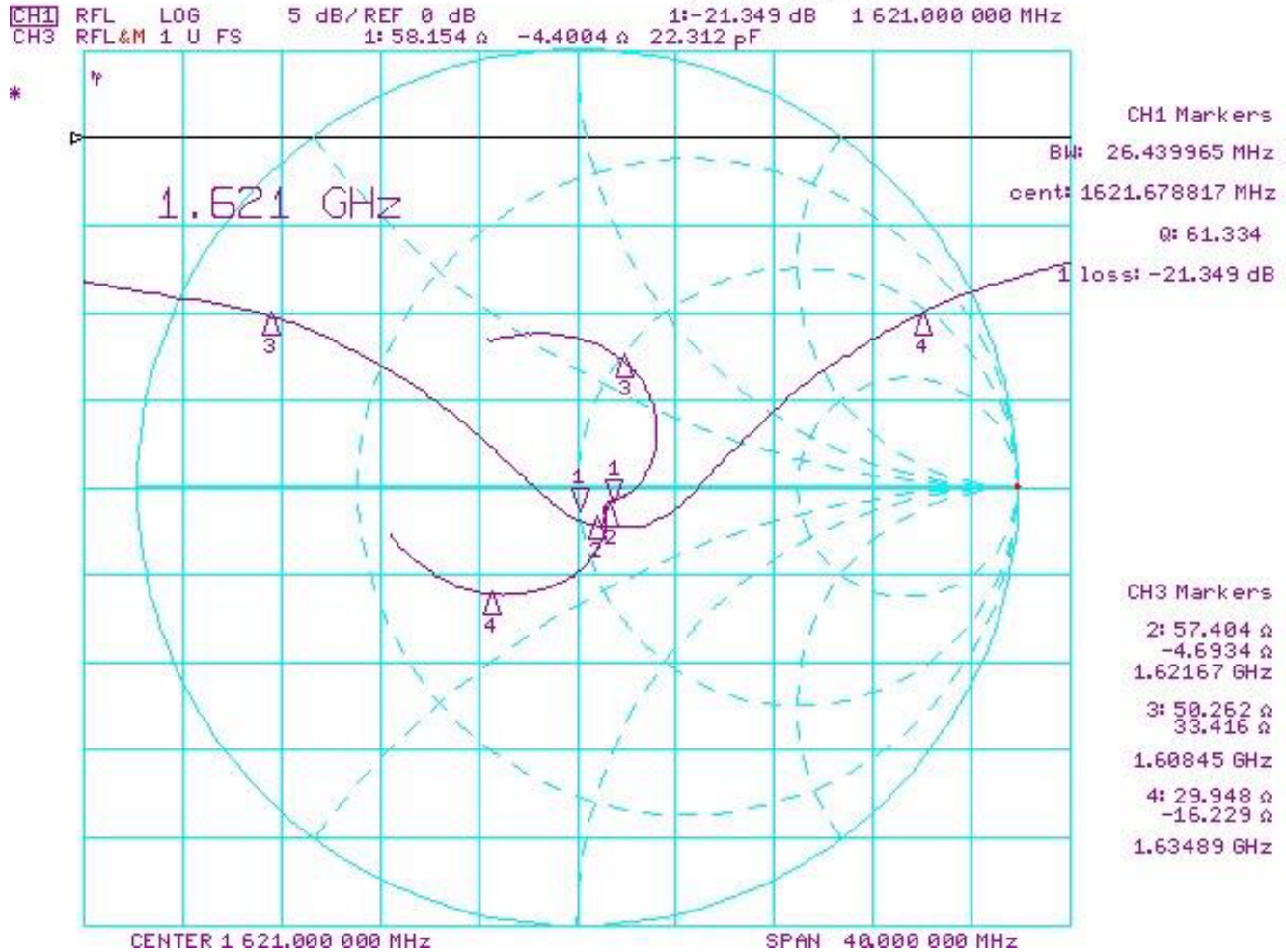

# External Iridium Antenna



AEARBD040038-S1621



40.5 x 38.0 x 12.3 mm  
RoHS/RoHS II Compliant  
MSL = N/A

## Radiation Pattern:

### 2D- Pattern

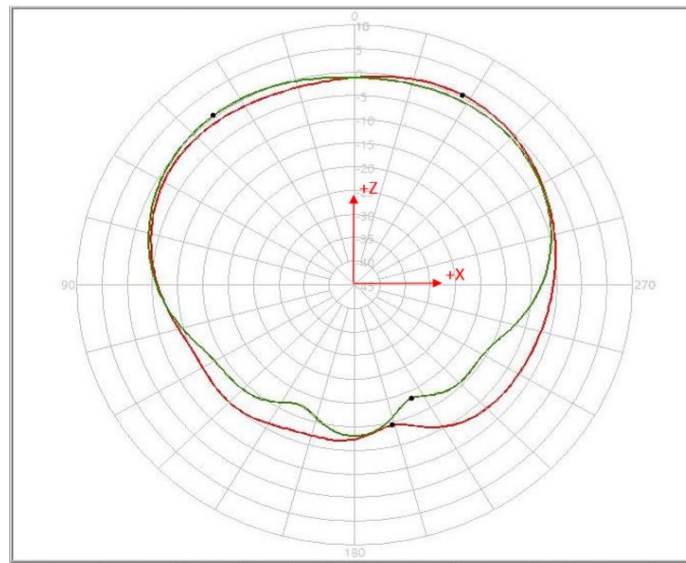

1621 MHz	Peak Gain	Zenith Gain (dBi)
XZ	0.46	-1.17
YZ	0.39	-1.16

## Packaging

The casing is of dimension 370.0 x 370.0 x 300.0 mm and contains 100 units in each.

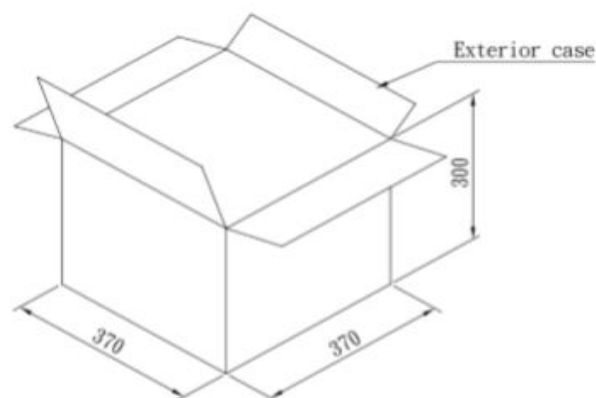

# External Iridium Antenna



AEARBD040038-S1621



40.5 x 38.0 x 12.3 mm  
RoHS/RoHS II Compliant  
MSL = N/A

## Reliability Tests

- i. Low-temperature test: Expose the specimen to  $-40^{\circ}\text{C}$  for 400 hours and then to normal temperature/ humidity for 24 hours or more. After this test, examine its appearance and functions.
- ii. High-temperature test: Expose the specimen to  $+105^{\circ}\text{C}$  for 400 hours and then to normal temperature/humidity for 24 hours or more. After this test, examine its appearance and functions.
- iii. High-temperature/ High-humidity test: Subject the object to the environmental conditions of  $+60^{\circ}\text{C}$  and 90 – 95 % R.H. for 96 hours, then expose to normal temperature/ humidity for 24 hours or more. After this test, examine its appearance and functions.
- iv. Thermal shock test: Subject the object to cyclic temperature change ( $-40^{\circ}\text{C}$ , 2 hours  $\leftrightarrow$   $+85^{\circ}\text{C}$ , 2 hours) for 100 cycles, then expose to normal temperature/humidity for 24 hours or more. After this test, examine its appearance and functions.
- v. Vibration test:
  - Sinusoidal vibration test: Subject the object to vibrations of 5 to 200 to 5 Hz swept in 10 minutes, 4.5 G at maximum (2 mm amplitude), in X and Y directions for two hours each and in Z direction for four hours. After this test, examine its appearance functions.
  - Vibration test in packaged condition: Subject the object, which is packaged as illustrated, to vibrations of 15 to 60 to 15 Hz swept in 6 minutes, 4 G at maximum (2 mm amplitude at maximum), applied in X, Y and Z directions for two hours each, i.e. six hours in total. After this test, examine its appearance and functions.
- vi. Free fall test in packaged condition: Drop the object, which is packaged as illustrated, to a concrete surface from the height of 90 cm, on one corner, three edges and six faces once each, i.e. 10 times in total. After this test, examine its appearance and functions.
- vii. Soldering heat resistance test: The lead pins of the unit are soaked in solder bath at  $260^{\circ}\text{C} \pm 5^{\circ}\text{C}$  for 10 seconds. After this test, examine its appearance and functions.
- viii. Adhesion test: The device is subjected to be soldered on test PCB. Then apply 0.5 Kg (5 N) of force for  $5 \pm 1$  seconds in the direction parallel to the substrate. (The soldering should be done by reflow and be conducted with care so that the soldering is uniform and free of defect by stress such as heat shock).

**ATTENTION:** Abracon LLC's products are COTS – Commercial-Off-The-Shelf products; suitable for Commercial, Industrial and, where designated, Automotive Applications. Abracon's products are not specifically designed for Military, Aviation, Aerospace, Life-dependent Medical applications or any application requiring high reliability where component failure could result in loss of life and/or property. For applications requiring high reliability and/or presenting an extreme operating environment, written consent and authorization from Abracon LLC is required. Please contact Abracon LLC for more information.



5101 Hidden Creek Ln Spicewood TX 78669  
Phone: 512-371-6159 | Fax: 512-351-8858  
For terms and conditions of sales, please visit:  
[www.abracon.com](http://www.abracon.com)

REVISED: 01.25.2019

ABRACON IS  
ISO9001-2015  
CERTIFIED