

ST-201

Aliases (UDLST002010000)
Common Mode Chokes - Signal, KEMET, ST, Through-Hole, Common Mode

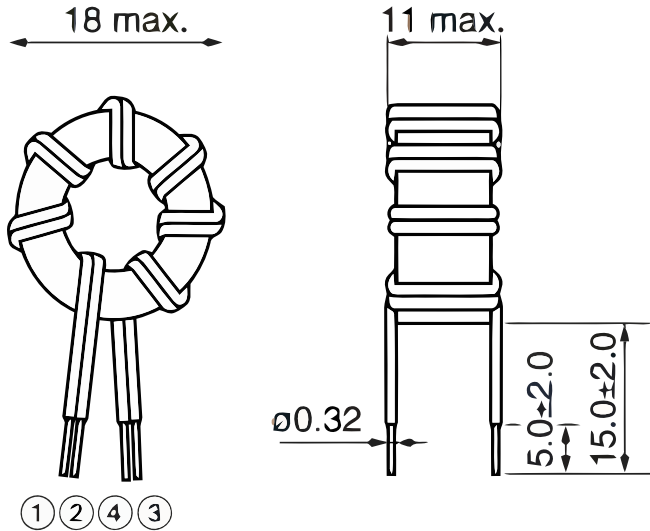

Click [here](#) for the 3D model.

General Information

Series	ST
Style	Through-Hole
RoHS	Yes
Miscellaneous	FM Band, Frequency Range: 7 To 40 MHz, Impedance: 1500 Ohms (7 MHz).

Dimensions

L	18mm MAX
T	11mm MAX
H	18mm MAX
LL	15mm +/-2mm
F	0.32mm NOM

Packaging Specifications

Packaging	Tray, Box
Packaging Quantity	1200
Typical Component Weight	2.66 g

Specifications

Voltage DC	50 VDC
Temperature Range	-20/+75°C
DC Resistance	0.1 Ohms (per Line MAX)

Statements of suitability for certain applications are based on our knowledge of typical operating conditions for such applications, but are not intended to constitute - and we specifically disclaim - any warranty concerning suitability for a specific customer application or use. This Information is intended for use only by customers who have the requisite experience and capability to determine the correct products for their application. Any technical advice inferred from this Information or otherwise provided by us with reference to the use of our products is given gratis, and we assume no obligation or liability for the advice given or results obtained.