



Main

Range of product	OsiSense XU
Series name	General purpose multimode
Electronic sensor type	Photo-electric sensor
Sensor name	XUM
Sensor design	Miniature
Detection system	Multimode
Material	Plastic
Type of output signal	Discrete
Supply circuit type	DC
Wiring technique	3-wire
Discrete output type	PNP
Discrete output function	1 NO or 1 NC programmable
Electrical connection	Cable
Cable length	16.40 ft (5 m)
Product specific application	-
Emission	Infrared diffuse Infrared diffuse with background suppression Infrared thru beam Red polarised reflex
[Sn] nominal sensing distance	9.84 Ft (3 m) polarised reflex need reflector XUZC50 32.81 Ft (10 m) thru beam need a transmitter XUM0AKSAL5T 0.33 Ft (0.1 m) diffuse with background suppression 1.31 ft (0.4 m) diffuse

Complementary

Enclosure material	PBT
Lens material	PMMA
Maximum sensing distance	45.93 Ft (14 m) thru beam 13.12 Ft (4 m) polarised reflex 0.33 Ft (0.1 m) diffuse with background suppression 1.80 ft (0.55 m) diffuse
Output type	Solid state
Add on output	With alarm output, 50 mA
Wire insulation material	PvR
Status LED	1 LED green)supply 1 LED red)instability 1 LED yellow)output state
[Us] rated supply voltage	12...24 V DC with reverse polarity protection
Switching capacity in mA	<= 100 mA overload and short-circuit protection)
Switching frequency	<= 250 Hz
Maximum voltage drop	<1.5 V closed state)
Current consumption	35 mA no-load
Maximum delay first up	100 ms
Maximum delay response	2 ms
Maximum delay recovery	2 ms
Setting-up	Self-teaching
Depth	0.79 in (20 mm)

Height	1.34 in (34 mm)
Maximum Width	0.47 in (12 mm)

Environment

Product certifications	CE CSA UL
Ambient air temperature for operation	-13...131 °F (-25...55 °C)
Ambient air temperature for storage	-40...158 °F (-40...70 °C)
Vibration resistance	7 gn +/- 1.5 mm 10...55 Hz) IEC 60068-2-6
Shock resistance	30 gn 11 ms) IEC 60068-2-27
IP degree of protection	IP65 double insulation IEC 60529 IP67 double insulation IEC 60529

Ordering and shipping details

Category	22481 - SENSORS, PHOTOELECTRIC
Discount Schedule	DS2
GTIN	03389110378702
Nbr. of units in pkg.	1
Package weight(Lbs)	0.41 lb(US) (0.19 kg)
Returnability	No
Country of origin	ID

Packing Units

Package 1 Height	0.420 dm
Package 1 width	0.970 dm
Package 1 Length	1.320 dm

Offer Sustainability

Sustainable offer status	Green Premium product
California proposition 65	WARNING: This product can expose you to chemicals including: Diisononyl phthalate (DINP), which is known to the State of California to cause cancer, and Di-isodecyl phthalate (DIDP), which is known to the State of California to cause birth defects or other reproductive harm. For more information go to www.P65Warnings.ca.gov
REACH Regulation	REACH Declaration
EU RoHS Directive	Pro-active compliance (Product out of EU RoHS legal scope) EU RoHS Declaration
Mercury free	Yes
RoHS exemption information	Yes
Environmental Disclosure	Product Environmental Profile
Circularity Profile	End Of Life Information

Contractual warranty

Warranty	18 months
----------	-----------

Dimensions

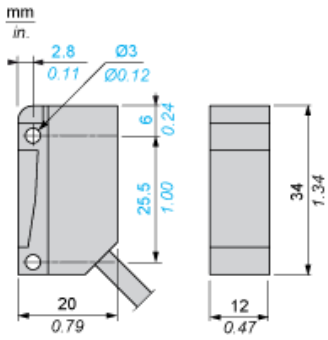

Wiring Schemes

Receiver, PNP Output

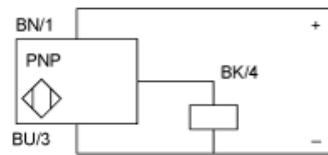

BN : Brown
BU : Blue
BK : Black

Detection Curves

With Thru-beam Accessory (Thru-beam)

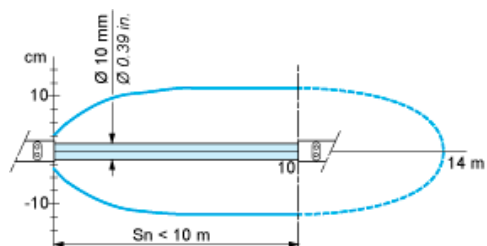

Without Accessory (Diffuse)

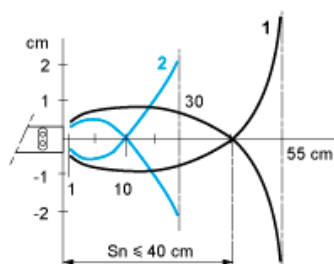

1 : White 90%
2 : Grey 18%
Object 10 x 10 cm

Without Accessory (Diffuse with background suppression)

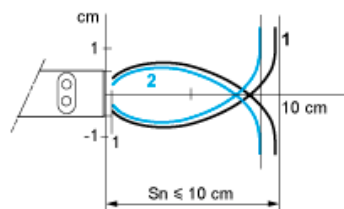

1 : White 90%
2 : Grey 18%
Object 10 x 10 cm

With reflector (Polarised reflex)

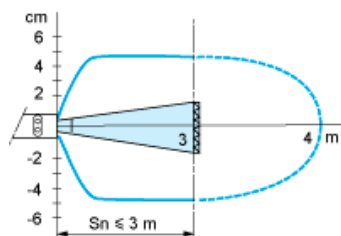

With reflector XU5C50

Variation of Usable Sensing Distance S_u (Without accessory, with adjustable background suppression)

Teach Mode at Minimum

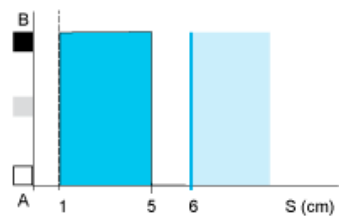

Teach Mode at Maximum

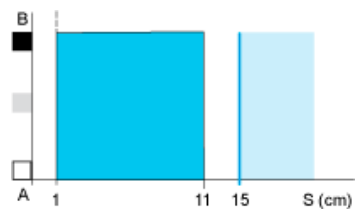

- (1) Black
- (2) Grey
- (3) White
- (4) Sensing range
- (5) Non sensing zone (matt surfaces)

A-B : Object reflection coefficient

- (1) Black 6%
- (2) Grey 18%
- (3) White 90%
- (4) Sensing range
- (5) Non sensing zone (matt surfaces)