

## 25 A, 1200 V Snubberless Triacs

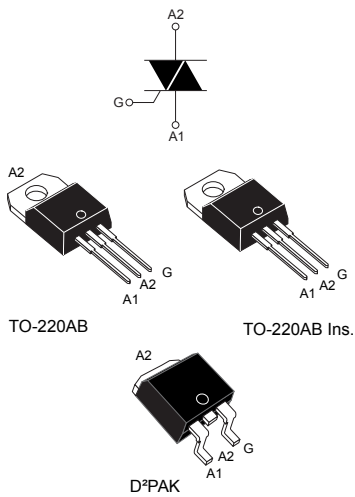

### Features

- On-state RMS current: 25 A
- Blocking voltage: 1200 V
- High static community and dynamic commutation
- $I_{GT} = 50 \text{ mA}$
- High endurance reliability
- Compact high voltage device

### Applications

- Motor control circuits
- Heating control circuits

### Description

The T2550-12x is a 25 A 1200 V Snubberless Triac available in three packages: D<sup>2</sup>PAK, TO-220AB and TO-220AB insulated.

Its 1200 V blocking voltage enables use in 3-phase industrial application. Its noise immunity and dynamic commutation makes it suitable for either inductive, capacitive or resistive load control.

#### Product status link

[T2550-12G, T2550-12T, T2550-12I](#)

#### Product summary

$I_{T(RMS)}$	25 A
$V_{DRM}/V_{RRM}$	1200 V
$I_{GT}$	50 mA

# 1 Characteristics

**Table 1. Absolute maximum ratings (limiting values,  $T_j = 25\text{ °C}$ , unless otherwise stated)**

Symbol	Parameters		Value	Unit	
$I_{T(RMS)}$	RMS on-state current (full sine wave)	D <sup>2</sup> PAK, TO-220AB	$T_c = 100\text{ °C}$	25	A
		TO-220AB Ins.	$T_c = 71\text{ °C}$		
$I_{TSM}$	Non repetitive surge peak on-state current (full cycle, $T_j$ initial = $25\text{ °C}$ )	$t_p = 20\text{ ms}$		240	A
		$t_p = 16.7\text{ ms}$		252	
$I^2t$	$I^2t$ value for fusing	$t_p = 10\text{ ms}$		380	A <sup>2</sup> s
$di/dt$	Critical rate of rise of on-state current $I_G = 2 \times I_{GT}$ , $t_r \leq 100\text{ ns}$	$f = 60\text{ Hz}$	$T_j = 125\text{ °C}$	100	A/ $\mu$ s
$V_{DRM}/V_{RRM}$	Repetitive peak off-state voltage			1200	V
$V_{DSM}/V_{RSM}$	Non repetitive surge peak off-state voltage	$t_p = 10\text{ ms}$		1300	V
$I_{GM}$	Peak gate current	$t_p = 20\text{ }\mu$ s		4	A
$V_{GM}$	Peak positive gate voltage	$t_p = 20\text{ }\mu$ s		16	V
$P_{G(AV)}$	Average gate power dissipation			1	W
$T_{stg}$	Storage junction temperature range			-40 to +150	°C
$T_j$	Operating junction temperature range			-40 to +125	°C
$V_{ins.}$	Insulation RMS voltage, 1 minute	TO-220AB Ins.		2500	V

**Table 2. Electrical characteristics ( $T_j = 25\text{ °C}$ , unless otherwise specified) - Snubberless™ (3 quadrants)**

Symbol	Parameters	Quadrant		Value	Unit
$I_{GT}$	$V_D = 12\text{ V}$ , $R_L = 33\text{ }\Omega$	I - II - III	Min.	2.5	mA
			Max.	50	
$V_{GT}$		I - II - III	Max.	1.3	V
$V_{GD}$	$V_D = V_{DRM}$ , $R_L = 3,3\text{ k}\Omega$ , $T_j = 125\text{ °C}$	I - II - III	Min.	0.2	V
$I_H^{(1)}$	$I_T = 500\text{ mA}$ , gate open		Max.	60	mA
$I_L$	$I_G = 1.2 I_{GT}$	I - II - III	Max.	80	mA
$dV/dt^{(1)}$	$V_D = 67\%$ $V_{DRM}$ gate open, $T_j = 125\text{ °C}$		Min.	2500	V/ $\mu$ s
$(di/dt)_c^{(1)}$	Without snubber, $T_j = 125\text{ °C}$		Min.	20	A/ms
$t_{gt}$	$I_{TM} = 13\text{ A}$ , $V_D = 400\text{ V}$ , $I_G = 100\text{ mA}$ , $di_G/dt = 100\text{ mA}/\mu$ s, $R_L = 30\text{ }\Omega$	I - II - III	Typ.	2	$\mu$ s

1. For both polarities of A2 referenced to A1

**Table 3. Static electrical characteristics**

Symbol	Test conditions	T <sub>j</sub>		Value	Unit
V <sub>TM</sub> <sup>(1)</sup>	I <sub>TM</sub> = 35 A, t <sub>p</sub> = 380 μs	25 °C	Max.	1.55	V
V <sub>TO</sub> <sup>(1)</sup>	threshold on-state voltage	125 °C	Max.	0.85	V
R <sub>D</sub> <sup>(1)</sup>	Dynamic resistance	125 °C	Max.	20	mΩ
I <sub>DRM</sub> I <sub>RPM</sub>	V <sub>D</sub> = V <sub>R</sub> = 1200 V	25 °C	Max.	10	μA
		125 °C		6	mA

1. For both polarities of A2 referenced to A1

**Table 4. Thermal resistance**

Symbol	Parameters			Value	Unit
R <sub>th(j-c)</sub>	Junction to case (AC)	TO-220AB / D <sup>2</sup> PAK	Max.	0.8	°C/W
		TO-220AB insulated		1.7	
R <sub>th(j-a)</sub>	Junction to ambient (S = 2 cm <sup>2</sup> ) <sup>(1)</sup>	D <sup>2</sup> PAK	Typ.	45	
	Junction to ambient	TO-220AB / TO-220AB ins		60	

1. Copper surface under tab.

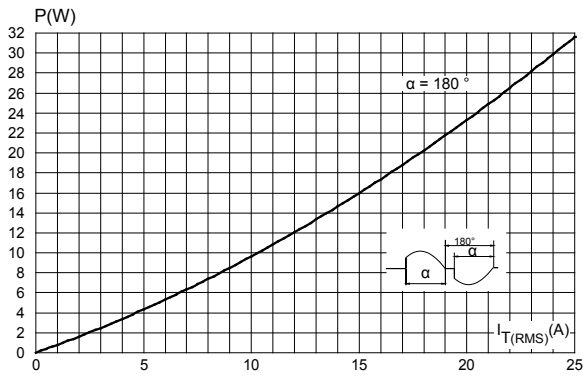
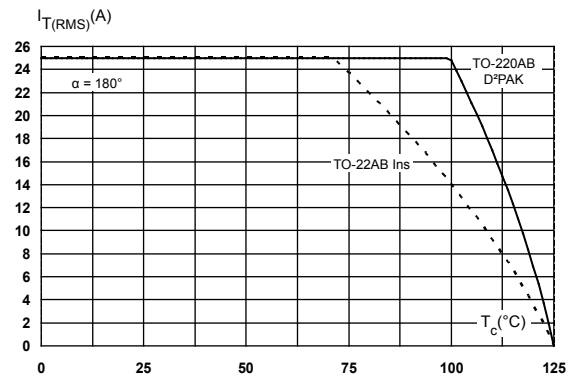
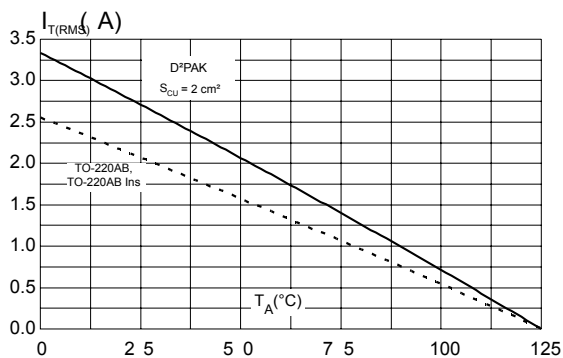
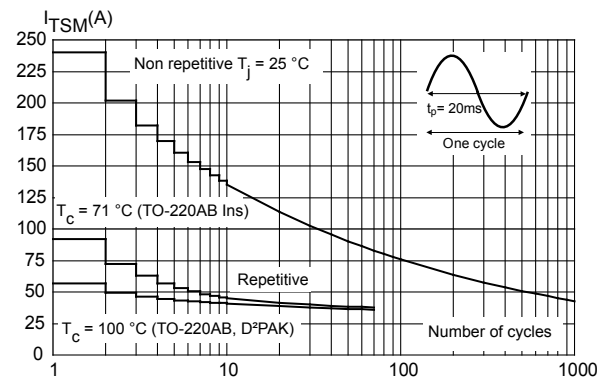
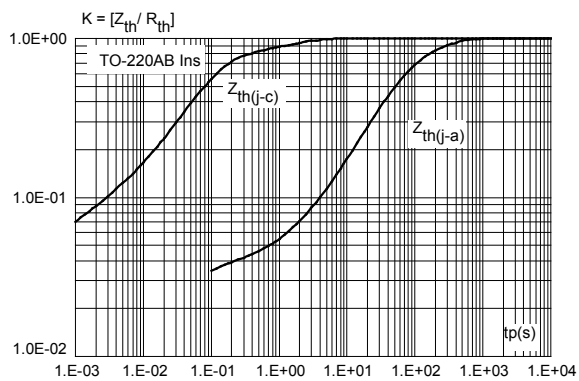
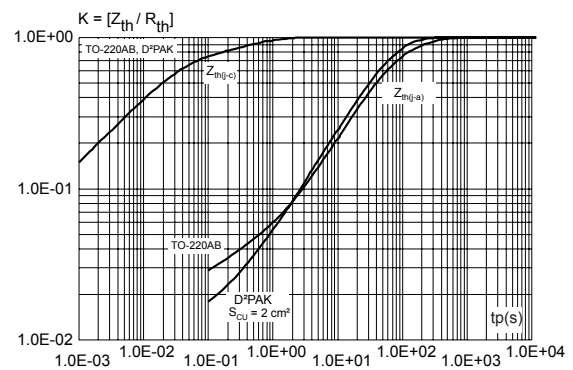
**1.1 Characteristics (curves)**
**Figure 1. Maximum power dissipation versus on-state RMS current (full cycle)**

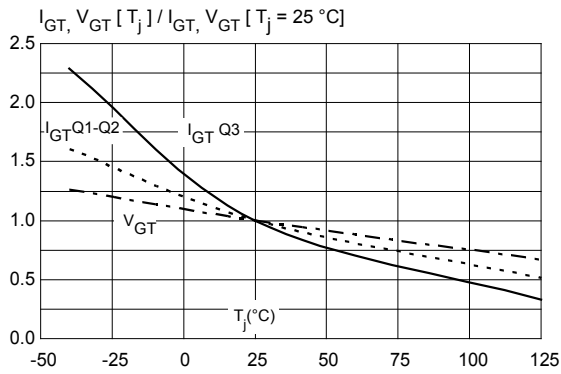
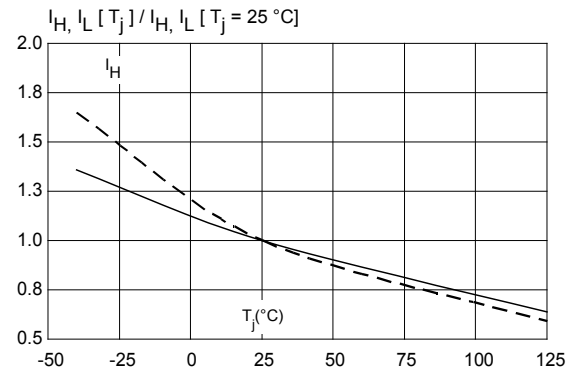
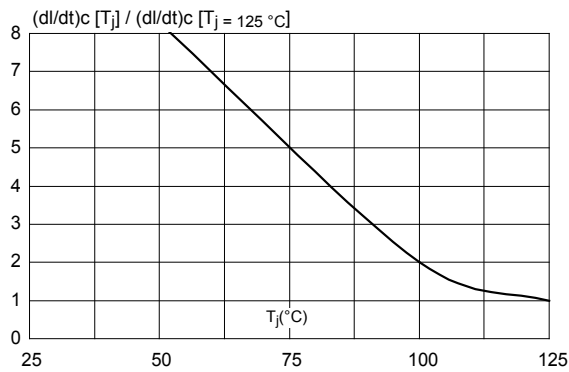
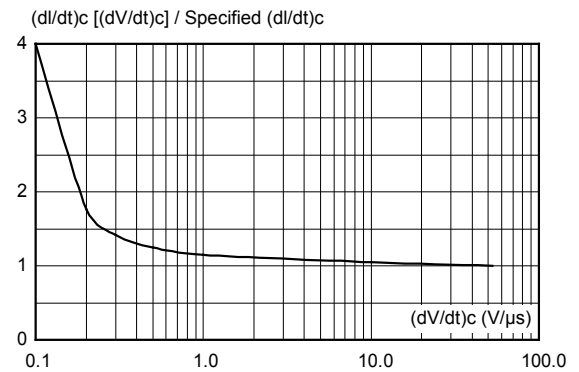
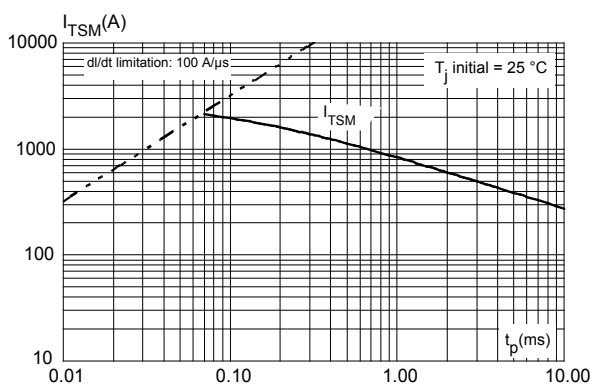
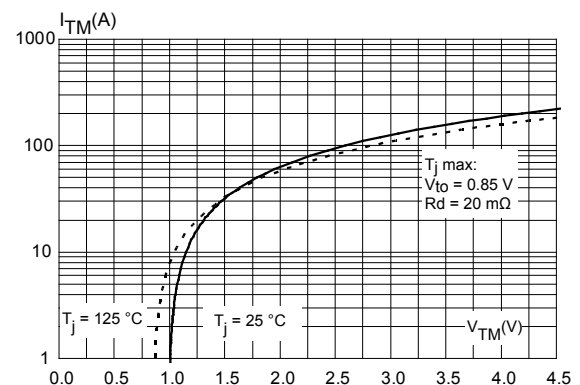
**Figure 2. RMS on-state current versus case temperature (full cycle)**

**Figure 3. On-state RMS current versus ambient temperature (free air convection)**

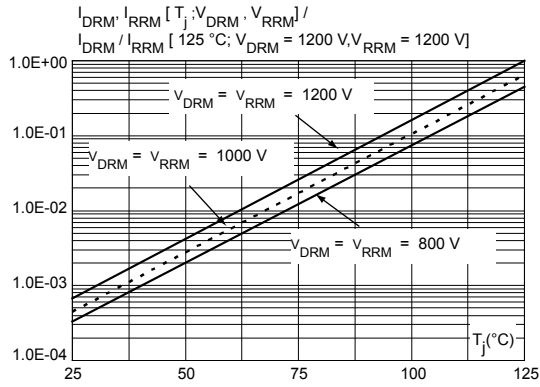
**Figure 4. Surge peak on-state current versus number of cycles**

**Figure 5. Relative variation of thermal impedance versus pulse duration (T2550-12I)**

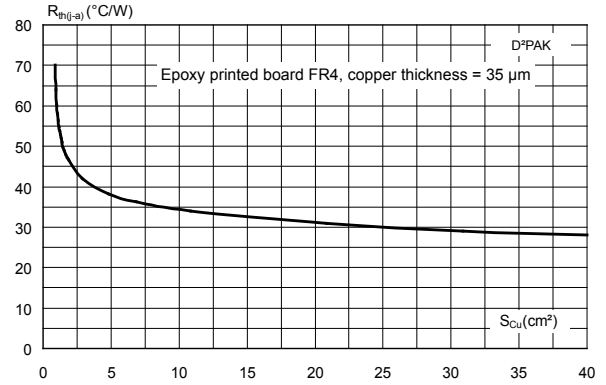
**Figure 6. Relative variation of thermal impedance versus pulse duration**

**Figure 7. Relative variation of gate trigger current and gate voltage versus junction temperature (typical values)**

**Figure 8. Relative variation of holding current and latching current versus junction temperature (typical values)**

**Figure 9. Relative variation of critical rate of decrease of main current versus junction temperature (typical values)**

**Figure 10. Relative variation of critical rate of decrease of main current versus reapplied dV/dt**

**Figure 11. Non repetitive surge peak on-state current versus sinusoidal pulse width (t\_p < 10 ms)**

**Figure 12. On-state characteristics (maximum values)**

**Figure 13. Relative variation of leakage current versus junction temperature for different values of blocking voltage (typical values)**



**Figure 14. D<sup>2</sup>PAK thermal resistance junction to ambient versus copper surface under tab**



## 2 Package information

In order to meet environmental requirements, ST offers these devices in different grades of **ECOPACK** packages, depending on their level of environmental compliance. ECOPACK specifications, grade definitions and product status are available at: [www.st.com](http://www.st.com). ECOPACK is an ST trademark.

### 2.1 D<sup>2</sup>PAK package information

- Epoxy meets UL 94,V0
- Lead-free package

**Figure 15. D<sup>2</sup>PAK package outline**

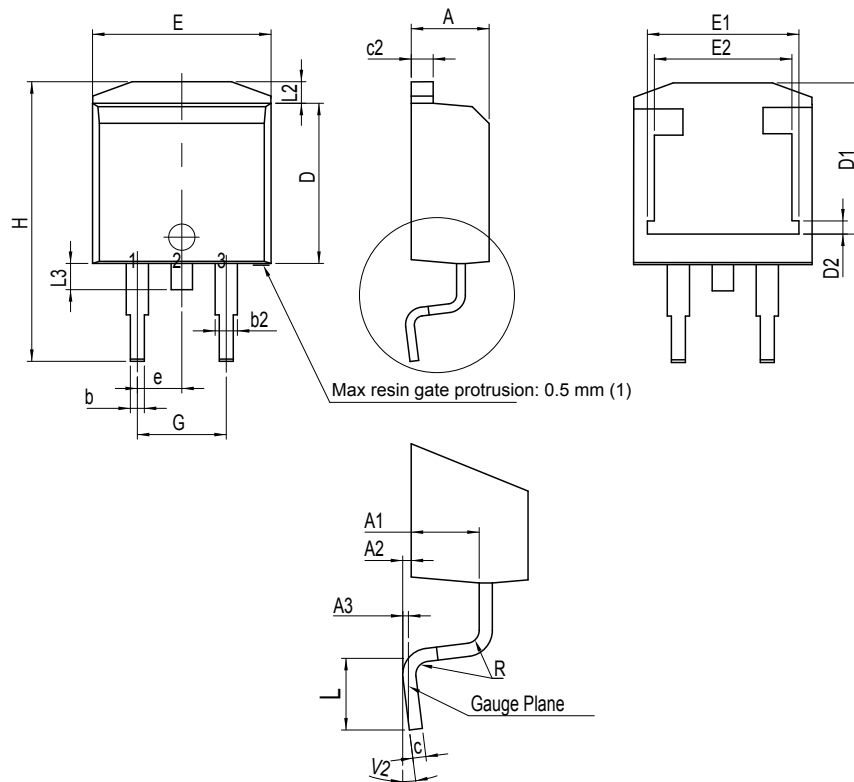

(1) Resin gate is accepted in each of position shown on the drawing, or their symmetrical.

**Table 5. D<sup>2</sup>PAK package mechanical data**

Ref.	Dimensions					
	Millimeters			Inches <sup>(1)</sup>		
	Min.	Typ.	Max.	Min.	Typ.	Max.
A	4.30		4.60	0.1693		0.1811
A1	2.49		2.69	0.0980		0.1059
A2	0.03		0.23	0.0012		0.0091
A3		0.25			0.0098	
b	0.70		0.93	0.0276		0.0366
b2	1.25		1.7	0.0492		0.0669
c	0.45		0.60	0.0177		0.0236
c2	1.21		1.36	0.0476		0.0535
D	8.95		9.35	0.3524		0.3681
D1	7.50		8.00	0.2953		0.3150
D2	1.30		1.70	0.0512		0.0669
e	2.54			0.1		
E	10.00		10.28	0.3937		0.4047
E1	8.30		8.70	0.3268		0.3425
E2	6.85		7.25	0.2697		0.2854
G	4.88		5.28	0.1921		0.2079
H	15		15.85	0.5906		0.6240
L	1.78		2.28	0.0701		0.0898
L2	1.27		1.40	0.0500		0.0551
L3	1.40		1.75	0.0551		0.0689
R		0.40			0.0157	
V2	0°		8°	0°		8°

1. Dimensions in inches are given for reference only

Figure 16. D<sup>2</sup>PAK recommended footprint (dimensions are in mm)

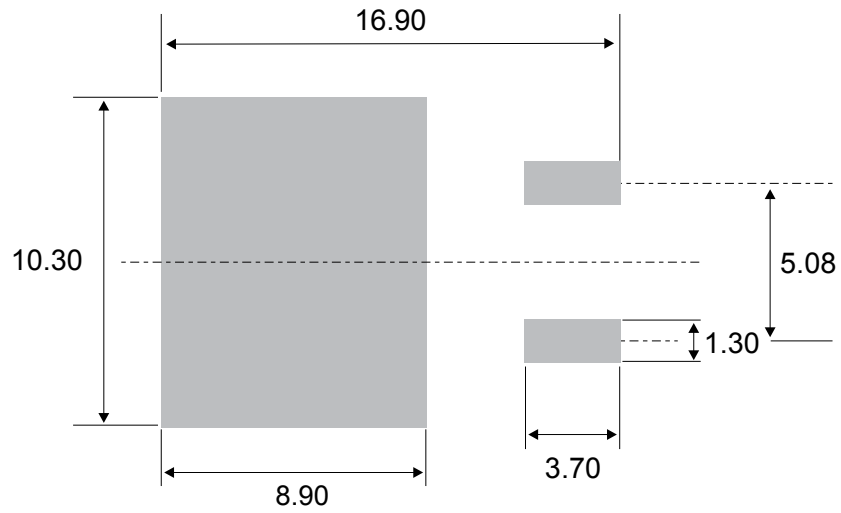
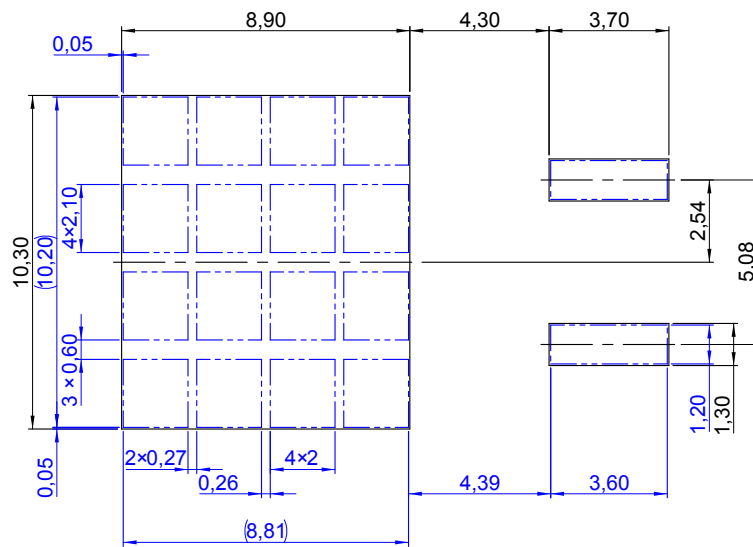

Figure 17. D<sup>2</sup>PAK footprint and stencil dimensions' definitions (dimensions in mm)



Note: Blue = Stencil, Black = Footprint

## 2.2 TO-220AB non ins. and insulated package information

- Molding compound resin is halogen-free and meets flammability standard UL94 level 0
- Lead-free package leads finishing
- Recommended torque: 0.4 to 0.6 N.m

Figure 18. TO-220AB non ins. and insulated package outline

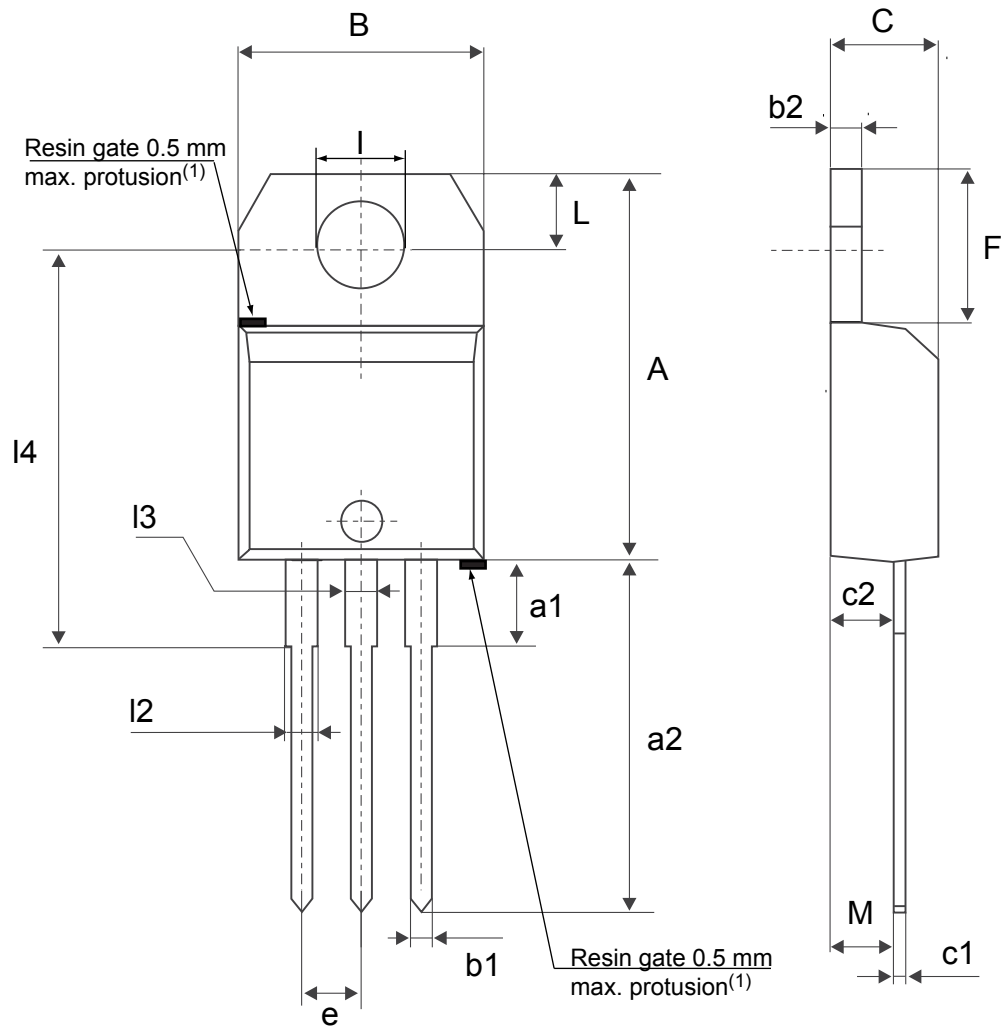

(1) Resin gate position accepted in one of the two positions or in the symmetrical opposites.

**Table 6. TO-220AB non ins. and insulated package mechanical data**

Ref.	Dimensions					
	Millimeters			Inches <sup>1</sup>		
	Min.	Typ.	Max.	Min.	Typ.	Max.
A	15.20		15.90	0.5984		0.6260
a1		3.75			0.1476	
a2	13.00		14.00	0.5118		0.5512
B	10.00		10.40	0.3937		0.4094
b1	0.61		0.88	0.0240		0.0346
b2	1.23		1.32	0.0484		0.0520
C	4.40		4.60	0.1732		0.1811
c1	0.49		0.70	0.0193		0.0276
c2	2.40		2.72	0.0945		0.1071
e	2.40		2.70	0.0945		0.1063
F	6.20		6.60	0.2441		0.2598
I	3.73		3.88	0.1469		0.1528
L	2.65		2.95	0.1043		0.1161
I2	1.14		1.70	0.0449		0.0669
I3	1.14		1.70	0.0449		0.0669
I4	15.80	16.40	16.80	0.6220	0.6457	0.6614
M		2.6			0.1024	

1. Inch dimensions are for reference only.

### 3 Ordering information

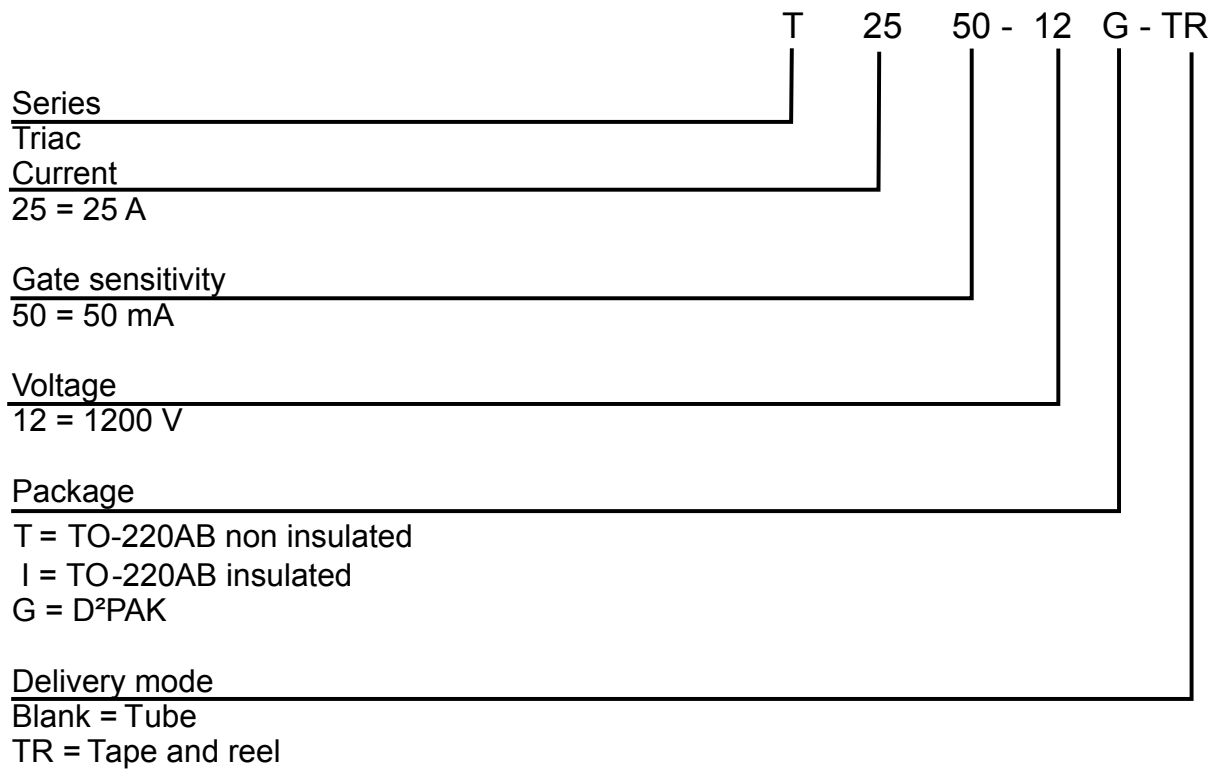
**Figure 19. Ordering information scheme**

**Table 7. Ordering information**

Order code	Marking	Package	Weight	Base qty.	Delivery mode
T2550-12G	T2550-12G	D <sup>2</sup> PAK	1.50 g	50	Tube
T2550-12G-TR				1000	Tape and reel 13"
T2550-12T	T2550-12T	TO-220AB	2.3 g	50	Tube
T2550-12I	T2550-12I	TO-220AB Ins.	2.3 g	50	Tube

## Revision history

**Table 8. Document revision history**

Date	Revision	Changes
9-Jan-2014	1	Initial release.
30-Jan-2014	2	Updated table 4.
10-Dec-2015	3	Inserted TO-220AB insulated package information and reformatted to current standard.
17-May-2019	4	Updated <a href="#">Table 1</a> , <a href="#">Table 4</a> and <a href="#">Figure 15</a> . Added <a href="#">Figure 18</a> . Minor text changed.

**IMPORTANT NOTICE – PLEASE READ CAREFULLY**

STMicroelectronics NV and its subsidiaries (“ST”) reserve the right to make changes, corrections, enhancements, modifications, and improvements to ST products and/or to this document at any time without notice. Purchasers should obtain the latest relevant information on ST products before placing orders. ST products are sold pursuant to ST’s terms and conditions of sale in place at the time of order acknowledgement.

Purchasers are solely responsible for the choice, selection, and use of ST products and ST assumes no liability for application assistance or the design of Purchasers’ products.

No license, express or implied, to any intellectual property right is granted by ST herein.

Resale of ST products with provisions different from the information set forth herein shall void any warranty granted by ST for such product.

ST and the ST logo are trademarks of ST. For additional information about ST trademarks, please refer to [www.st.com/trademarks](http://www.st.com/trademarks). All other product or service names are the property of their respective owners.

Information in this document supersedes and replaces information previously supplied in any prior versions of this document.

© 2019 STMicroelectronics – All rights reserved