



Main

Range of product	Harmony Relay
Product or component type	Socket
Contact terminal arrangement	Separate
Product compatibility	Plug-in relay RSL 1 C/O 60 V DC Plug-in relay RSL
Shape of pin	Flat
Device short name	RSLZ
Device presentation	Basic element
Sale per indivisible quantity	10
Switching voltage	110 V AC/DC

Complementary

[I _{th}] conventional free air thermal current	6 A
[U _e] rated operational voltage	< 300 V AC
Tightening torque	< 0.5 N.m M2.5
Fixing mode	Plastic compression spring 35 mm symmetrical DIN rail)
Marking	CE
CAD overall width	0.24 in (6.2 mm)
CAD overall height	3.09 in (78.6 mm)
CAD overall depth	3.74 in (95 mm)
Net Weight	0.05 lb(US) (0.023 kg)
Rated operational voltage limits	88...126.5 V
Group of product	RSL_CON_110
Compatibility code	RSLZ

Environment

Connections - terminals	Connector, 1 x 0.2...1 x 2.5 mm ² AWG 24...AWG 14) flexible with cable end Connector, 1 x 0.2...1 x 2.5 mm ² AWG 24...AWG 14) solid without cable end
Standards	IEC 61984 UL 508
Product certifications	GOST CSA
Ambient air temperature for storage	-40...185 °F (-40...85 °C)
Ambient air temperature for operation	-40...131 °F (-40...55 °C)
IP degree of protection	IP20 conforming to EN/IEC 60529
Dielectric strength	2500 V

Ordering and shipping details

Category	21127 - ZELIO ICE CUBE RELAYS
Discount Schedule	CP2
GTIN	00785901458371
Nbr. of units in pkg.	10
Package weight(Lbs)	0.06 lb(US) (0.03 kg)
Returnability	No
Country of origin	CN

Packing Units

Package 1 Height	0.070 dm
Package 1 width	0.800 dm
Package 1 Length	1.020 dm

Offer Sustainability

Sustainable offer status	Green Premium product
California proposition 65	WARNING: This product can expose you to chemicals including: Nickel compounds, which is known to the State of California to cause cancer, and Di-isodecyl phthalate (DIDP), which is known to the State of California to cause birth defects or other reproductive harm. For more information go to www.P65Warnings.ca.gov
REACH Regulation	REACH Declaration
REACH free of SVHC	Yes
EU RoHS Directive	Pro-active compliance (Product out of EU RoHS legal scope) EU RoHS Declaration
Toxic heavy metal free	Yes
Mercury free	Yes
RoHS exemption information	Yes
China RoHS Regulation	China RoHS Declaration
Environmental Disclosure	Product Environmental Profile
Circularity Profile	End Of Life Information
WEEE	The product must be disposed on European Union markets following specific waste collection and never end up in rubbish bins.

Contractual warranty

Warranty	18 months
----------	-----------

Dimensions

mm
in.

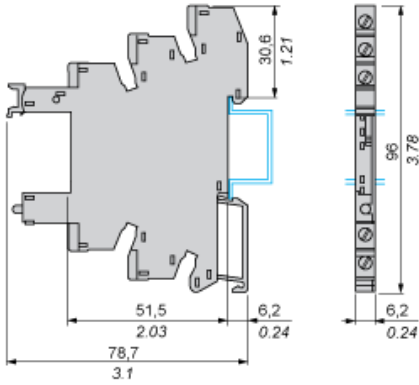

Wiring Diagram

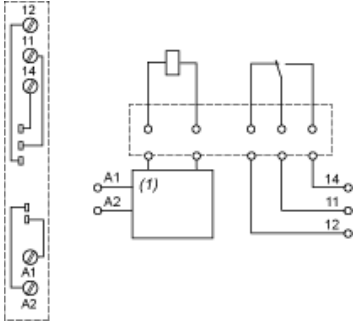

(1) Protection circuit

Example of RSLZ2 Bus Jumper Mounting on Sockets

Side View

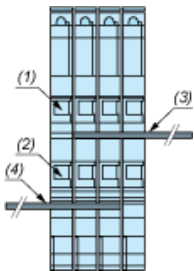

- (1) A1
- (2) A2
- (3) Bus jumper polarity A1
- (4) Bus jumper polarity A2