

# XPSMC16Z

safety controller XPS-MC - 24 V DC - 16 input - 30 LEDs signalling



## Main

Range of product	Preventa Safety automation
Product or component type	Configurable safety controller
Safety module name	XPSMC
Safety use category	Category 4 maximum EN 954-1/EN/ISO 13849-1 PLE maximum EN/ISO 13849-1 SIL 3 maximum IEC 61508
Type of start	Configurable
Standards	EN 574/ISO 13851 EN 1760-1/ISO 13856-1 EN/IEC 61496-1 EN/IEC 60204-1 IEC 61508 EN/IEC 60947-5-1 EN 954-1/EN/ISO 13849-1
Product certifications	TÜV UL CSA
[Us] rated supply voltage	24 V DC - 20...20 %
Number of inputs	16
Communication port protocol	Modbus 1 RJ45, serial link 1200 bps, 2400 bps, 4800 bps, 9600 bps or 19200 bps
Safety level	Can reach PL e/category 4 EN 954-1/EN/ISO 13849-1 Can reach SIL 3 IEC 61508

## Complementary

Function of module	Dynamic monitoring of hydraulic valves on linear presses Eccentric press Emergency stop monitoring, with or without time delay, 1 or 2-channel wiring Enabling switch monitoring, 2 or 3 contacts Foot switch monitoring Guard monitoring for injection presses and blowing machines Guard monitoring with 1 or 2 limit switches Hydraulic press Magnetic switch monitoring Monitoring safety stop at top dead centre on eccentric press Muting function of light curtains Position selector Safety mat monitoring Safety time delays Shaft/Chain breaking monitor Zero speed detection Light curtain monitoring category 4 EN/IEC 61496 Two-hand control category 3 EN 574/ISO 13851
Synchronisation time between inputs	Depending on configuration selected
Power consumption in W	12 W
Input protection type	External fuse 16 A
[Uc] control circuit voltage	28.8 V
Maximum line resistance	100 Ohm <math><6561.68 \text{ ft}</math> (2000 m)
Output type	2 relays, 2 NO contacts (4 NO total) Solid state, 6, volt-free
Breaking capacity	180 VA holding AC-15 C300 relay output 1800 VA inrush AC-15 C300 relay output
Breaking capacity	2 A 24 V static output circuit 1.5 A 24 V DC-13)50 ms relay output

The information provided in this documentation contains general descriptions and/or technical characteristics of the performance of the products contained herein. This documentation is not intended as a substitute for and is not to be used for determining suitability or reliability of these products for specific user applications. It is the duty of any such user or integrator to perform the appropriate and complete risk analysis, evaluation and testing of the products with respect to the relevant specific application or use thereof. Neither Schneider Electric Industries SAS nor any of its affiliates or subsidiaries shall be responsible or liable for misuse of the information contained herein.

Output thermal current	4 A for both outputs simultaneously 6 A for 1 output and 2 A for the other relay output
[I <sub>th</sub> ] conventional free air thermal current	16 A relay output 6.5 A static output circuit
Associated fuse rating	16 A gL power supply 4 A gL relay output 6 A fast blow relay output
Minimum output current	10 mA relay output
Minimum output voltage	17 V relay output
Response time	Configurable : 20 ms or 30 ms with software XPSMCWIN
[U <sub>i</sub> ] rated insulation voltage	300 V 2)IEC 60647-5-1, DIN VDE 0110 part 1
[U <sub>imp</sub> ] rated impulse withstand voltage	4 kV III IEC 60647-5-1, DIN VDE 0110 part 1
Method of access	Slave
Exchange size	14 words
Number of addresses	1...247 Modbus
Parity	Even Modbus No Modbus Odd Modbus
Data format	1 start bit/8 data bits 1 stop bit even or odd 2 stop bits without parity RTU (Remote Terminal Unit) mode
Supported modbus function	01 8-bit output data/32-bit input data 02 32-bit input data/8-bit output data 03 information and errors
Local signalling	30 LEDs
Mounting support	Mounting plate
Depth	6.02 in (153 mm)
Height	5.96 in (151.5 mm)
Maximum Width	2.91 in (74 mm)
Net Weight	1.81 lb(US) (0.82 kg)

## Environment

IP degree of protection	IP20 conforming to EN/IEC 60529
Ambient air temperature for operation	14...131 °F (-10...55 °C)
Ambient air temperature for storage	-13...185 °F (-25...85 °C)

## Ordering and shipping details

Category	22477 - SAFETY MODULES (PREVENTA)
Discount Schedule	SAF2
GTIN	00785901974932
Nbr. of units in pkg.	1
Package weight(Lbs)	2.59 lb(US) (1.17 kg)
Returnability	Yes
Country of origin	FR

## Packing Units

Unit Type of Package 1	PCE
Package 1 Height	3.74 in (9.5 cm)
Package 1 width	7.09 in (18 cm)
Package 1 Length	10.24 in (26 cm)
Unit Type of Package 2	S04
Number of Units in Package 2	6
Package 2 Weight	18.45 lb(US) (8.371 kg)
Package 2 Height	11.81 in (30 cm)
Package 2 width	15.75 in (40 cm)
Package 2 Length	23.62 in (60 cm)

## Offer Sustainability

California proposition 65	WARNING: This product can expose you to chemicals including: Lead and lead compounds, which is known to the State of California to cause cancer and birth defects or other reproductive harm. For more information go to <a href="http://www.P65Warnings.ca.gov">www.P65Warnings.ca.gov</a>
EU RoHS Directive	Pro-active compliance (Product out of EU RoHS legal scope) <a href="#">EU RoHS Declaration</a>
Mercury free	Yes
RoHS exemption information	<a href="#">Yes</a>
China RoHS Regulation	<a href="#">China RoHS Declaration</a>
Environmental Disclosure	<a href="#">Product Environmental Profile</a>
Circularity Profile	<a href="#">End Of Life Information</a>
WEEE	The product must be disposed on European Union markets following specific waste collection and never end up in rubbish bins.
PVC free	Yes

## Contractual warranty

Warranty	18 months
----------	-----------

## Dimensions

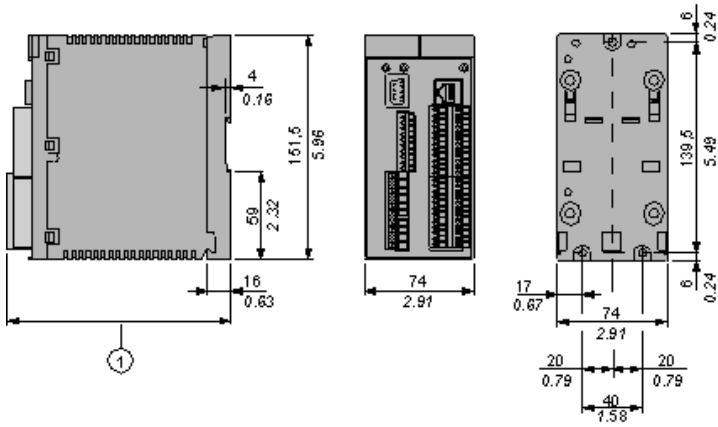

- 1 When using XPSMCTS• connectors this dimension is 153 mm (6.02 in)  
When using XPSMCTC• connectors this dimension is 151,5 mm (5.96 in)

## Installation

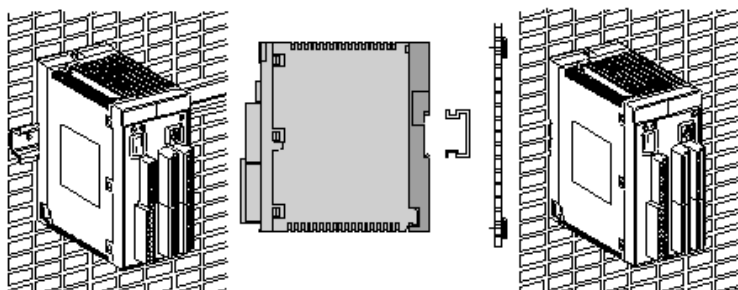

Metal adaptor for fixing on metal: DIN rail 35 mm/1.38 in.

## Wiring Diagrams

### Refer to the Instruction Sheet

To download the instruction sheet, follow below procedure:

**XPSAC5121**  
module XPSAC - Emergency stop - 24 V AC DC  
[Download XPSAC5121 product datasheet](#)

Download & Documents 1 to 3 of 3 (Total: -1)

**Instruction sheet**

XPSAC... Safety module for emergency stop and switch monitoring	English 2012-07-04	pdf (28)
---	--------------------	----------

**Image of product**

Emergency stop and switch monitoring	2010-11-10	{Select : }
--------------------------------------	------------	-------------

**Certificate**



Russian certificate	English 2010-07-07	pdf (60)
---------------------	--------------------	----------

1

2

- 1 Click on Download & Documents.
- 2 Click on Instruction sheet.

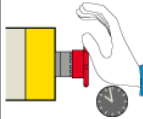
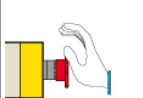
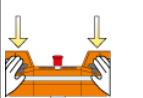
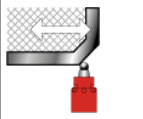
Safety Functions

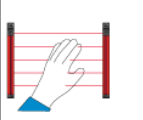
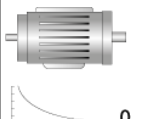
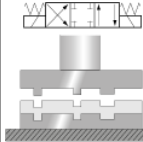
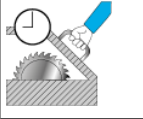
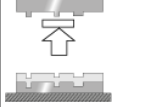
	<ul style="list-style-type: none"> <li>• Emergency stop monitoring with time delay:                             <ul style="list-style-type: none"> <li>○ 1 channel wiring, with automatic start.</li> <li>○ 2 channel wiring, with start button.</li> </ul> </li> </ul>
	<ul style="list-style-type: none"> <li>• Emergency stop monitoring without time delay:                             <ul style="list-style-type: none"> <li>○ 1 channel wiring, with automatic start.</li> <li>○ 2 channel wiring, with start button.</li> </ul> </li> </ul>
	<ul style="list-style-type: none"> <li>• Two-hand control.</li> </ul>
	<ul style="list-style-type: none"> <li>• Guard monitoring:                             <ul style="list-style-type: none"> <li>○ with 1 limit switch.</li> <li>○ with 2 limit switches.</li> <li>○ with 2 limit switches, with guard locking.</li> </ul> </li> <li>• Guard monitoring for injection presses and blowing machines.</li> </ul>
	<ul style="list-style-type: none"> <li>• Magnetic switch monitoring.</li> </ul>
	<ul style="list-style-type: none"> <li>• Sensing mat monitoring.</li> </ul>
	<ul style="list-style-type: none"> <li>• Light curtains monitoring:                             <ul style="list-style-type: none"> <li>○ Relay output type.</li> <li>○ Solid-state output type.</li> </ul> </li> <li>• "Muting" function for light curtains.</li> </ul>
	<ul style="list-style-type: none"> <li>• Zero speed detection.</li> </ul>
	<ul style="list-style-type: none"> <li>• Dynamic monitoring of hydraulic valves on linear presses.</li> </ul>
	<ul style="list-style-type: none"> <li>• Safety time delays.</li> </ul>
	<ul style="list-style-type: none"> <li>• Monitoring safety stop at top dead centre on eccentric press.</li> <li>• Hydraulic press.</li> <li>• Eccentric press.</li> </ul>



- Enabling switching monitoring:
  - 2 contact type.
  - 3 contact type.

Other functions:

- Foot switch monitoring
- Chain shaft breakage monitoring
- Position selector