



Main

Range of product	Harmony XAP
Product or component type	Die-cast empty control station
Device short name	XAPM
Product destination	For Ø 22 mm control and signalling units
Product front plate size	80 x 130 mm
Usable depth	2.93 in (74.5 mm)
Number of cut-out	2 cut-outs
Colour of base of enclosure	Blue
Colour of cover	Blue
Material	Zinc alloy
Cable entry	1 hole with blanking plug for cable gland 0.55 in (14 mm) 1 hole without blanking plug for cable gland 0.55 in (14 mm)
Device mounting	Flush
IP degree of protection	IP65 conforming to IEC 60529 IP69 NF C 20-010 IP69K

Complementary

Number of vertical rows	1
Net Weight	1.79 lb(US) (0.81 kg)

Environment

Protective treatment	TC
Ambient air temperature for storage	-40...158 °F (-40...70 °C)
Ambient air temperature for operation	-40...158 °F (-40...70 °C)
Overvoltage category	Class I IEC 60536 Class I conforming to NF C 20-030

Ordering and shipping details

Category	22475 - WALL STATIONS
Discount Schedule	CS2
GTIN	00785901450412
Nbr. of units in pkg.	1
Package weight(Lbs)	2.03 lb(US) (0.92 kg)
Returnability	No
Country of origin	MA

Packing Units

Unit Type of Package 1	PCE
Package 1 Height	3.46 in (8.8 cm)
Package 1 width	3.62 in (9.2 cm)
Package 1 Length	6.10 in (15.5 cm)
Unit Type of Package 2	S03
Number of Units in Package 2	12

Package 2 Weight	27.51 lb(US) (12.477 kg)
Package 2 Height	11.81 in (30 cm)
Package 2 width	11.81 in (30 cm)
Package 2 Length	15.75 in (40 cm)
Unit Type of Package 3	P06
Number of Units in Package 3	48
Package 3 Weight	124.18 lb(US) (56.328 kg)
Package 3 Height	30.31 in (77 cm)
Package 3 width	31.50 in (80 cm)
Package 3 Length	23.62 in (60 cm)

Offer Sustainability

Sustainable offer status	Green Premium product
California proposition 65	WARNING: This product can expose you to chemicals including: Di-isodecyl phthalate (DIDP), which is known to the State of California to cause birth defects or other reproductive harm. For more information go to www.P65Warnings.ca.gov
REACH Regulation	REACH Declaration
REACH free of SVHC	Yes
EU RoHS Directive	Pro-active compliance (Product out of EU RoHS legal scope) EU RoHS Declaration
Toxic heavy metal free	Yes
Mercury free	Yes
RoHS exemption information	Yes
China RoHS Regulation	China RoHS Declaration
Environmental Disclosure	Product Environmental Profile
Circularity Profile	End Of Life Information

Contractual warranty

Warranty	18 months
----------	-----------

Dimensions and Fixing

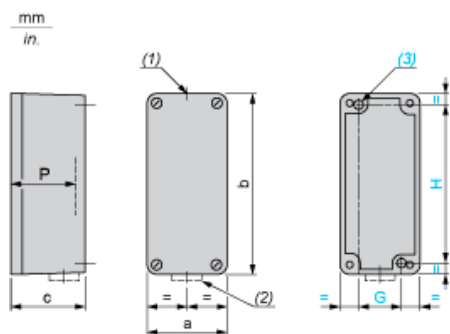

- (1) 1 hole, without blanking plug, for cable gland with 14 mm/0.55 in. maximum clamping capacity
 - (2) 1 hole, with blanking plug (protrusion 6 mm/0.23 in.), for cable gland with 14 mm/0.55 in. maximum clamping capacity
 - (3) 2 x Ø 5.6 mm/0.22 in. holes, depth 20 mm/0.78 in.
- P Usable depth

a		b		c		G		H		P	
mm	in.	mm	in.	mm	in.	mm	in.	mm	in.	mm	in.
80	3.15	130	5.12	77	3.03	50	1.97	155	4.53	74.5	2.93

Refer to the product characteristics to get the number of cut-outs.

Cut-out interaxis dimensions

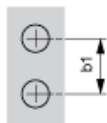

b1 Vertical interaxis: 40 mm/1.57 in.