

200 V ultrafast recovery diode

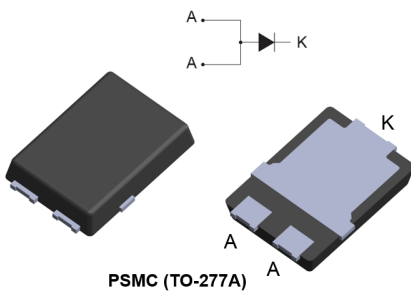

Features

- Low profile design – package typical height of 1.1 mm typ.
- Wettable flanks for automatic visual inspection
- Very low conduction losses
- Negligible switching losses
- High junction temperature capability
- ECOPACK[®]2 compliant

Applications

- DC/DC converter
- High frequency inverter
- Snubber
- Boost function
- Freewheeling diode

Description

This device is an ultrafast recovery diode optimized for switching mode base drive and transistor circuits.

Packaged in PSMC (TO-277A), the **STTH802SF** provides a high level of performance in a compact and flat package which can withstand very high operating junction temperature.

Product status link	
STTH802SF	
Product summary	
Symbol	Value
$I_{F(AV)}$	8 A
V_{RRM}	200 V
T_j (max.)	175 °C
V_F (typ.)	0.79 V
t_{rr} (typ.)	17 ns

1 Characteristics

Table 1. Absolute ratings (limiting values at 25 °C, unless otherwise specified, anode terminals short-circuited)

Symbol	Parameter	Value	Unit
V_{RRM}	Repetitive peak reverse voltage	200	V
$I_{F(AV)}$	Average forward current, $\delta = 0.5$ square pulse	$T_c = 145\text{ °C}$	8 A
I_{FSM}	Surge non repetitive forward current	$t_p = 10\text{ ms}$ sinusoidal	150 A
T_{stg}	Storage temperature range	-65 to +175	°C
T_j	Maximum operating junction temperature	+175	°C

Table 2. Thermal resistance parameters

Symbol	Parameter	Typ. value	Unit
$R_{th(j-c)}$	Junction to case	2.4	°C/W

For more information, please refer to the following application note:

- AN5088 : Rectifiers thermal management, handling and mounting recommendations

Table 3. Static electrical characteristics (anode terminals short-circuited)

Symbol	Parameter	Test conditions	Min.	Typ.	Max.	Unit
$I_R^{(1)}$	Reverse leakage current	$T_j = 25\text{ °C}$	-	6	60	μA
		$T_j = 125\text{ °C}$				
$V_F^{(2)}$	Forward voltage drop	$T_j = 25\text{ °C}$	-	0.94	1.08	V
		$T_j = 125\text{ °C}$		0.79	0.91	

1. Pulse test: $t_p = 5\text{ ms}$, $\delta < 2\%$

2. Pulse test: $t_p = 380\text{ }\mu\text{s}$, $\delta < 2\%$

To evaluate the conduction losses, use the following equation: $P = 0.77 \times I_{F(AV)} + 0.018 \times I_F^2(RMS)$

For more information, please refer to the following application notes related to the power losses:

- AN604: Calculation of conduction losses in a power rectifier
- AN4021: Calculation of reverse losses in a power diode

Table 4. Dynamic electrical characteristics

Symbol	Parameter	Test conditions	Min.	Typ.	Max.	Unit	
t_{rr}	Reverse recovery time	$T_j = 25\text{ °C}$	$I_F = 1.0\text{ A}$, $di_F/dt = -50\text{ A}/\mu\text{s}$, $V_R = 30\text{ V}$	-		35	ns
			$I_F = 1.0\text{ A}$, $di_F/dt = -100\text{ A}/\mu\text{s}$, $V_R = 30\text{ V}$	-	17	22	
I_{RM}	Reverse recovery current	$T_j = 125\text{ °C}$	$I_F = 8\text{ A}$, $di_F/dt = -200\text{ A}/\mu\text{s}$, $V_R = 160\text{ V}$	-	5.8	7.5	A
Q_{rr}	Reverse recovery charge			-	100		nC

1.1 Characteristics (curves)

Figure 1. Average forward power dissipation versus average forward current

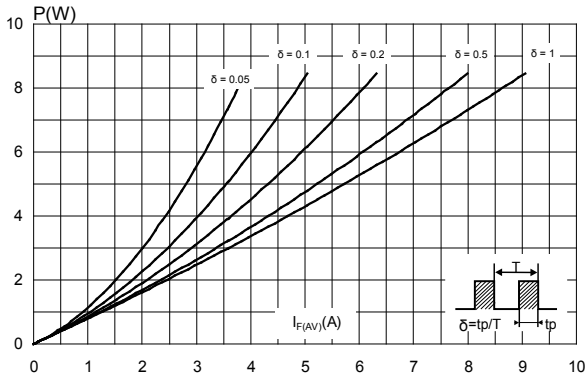

Figure 2. Forward voltage drop versus forward current (typical values)

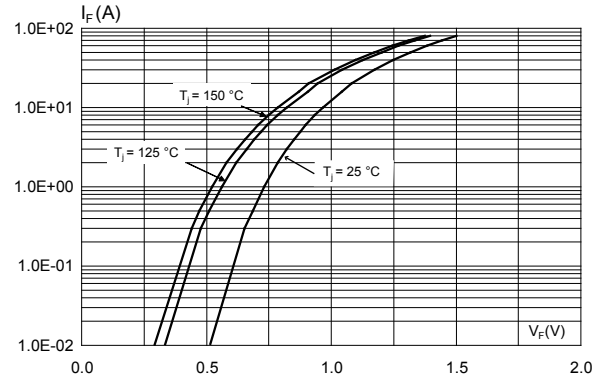

Figure 3. Forward voltage drop versus forward current (maximum values)

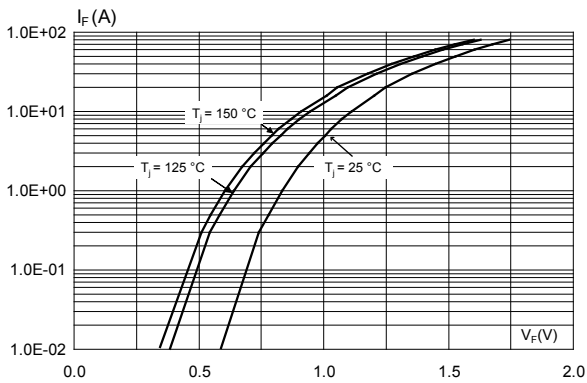

Figure 4. Relative variation of thermal impedance junction to case versus pulse duration

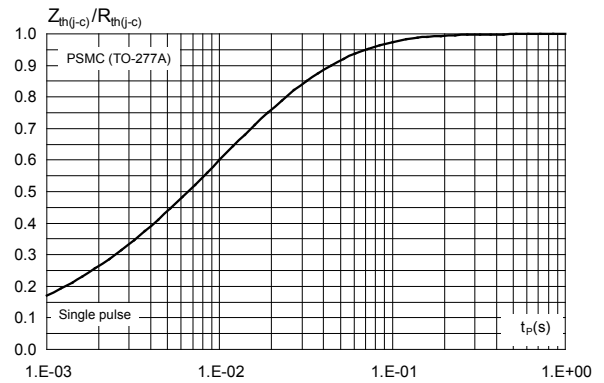

Figure 5. Peak reverse recovery current versus di_F/dt (typical values)

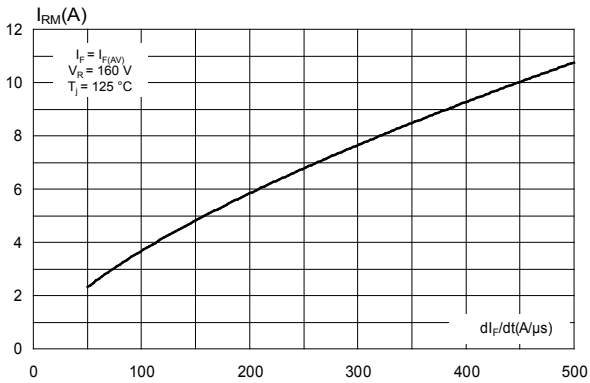

Figure 6. Reverse recovery time versus di_F/dt (typical values)

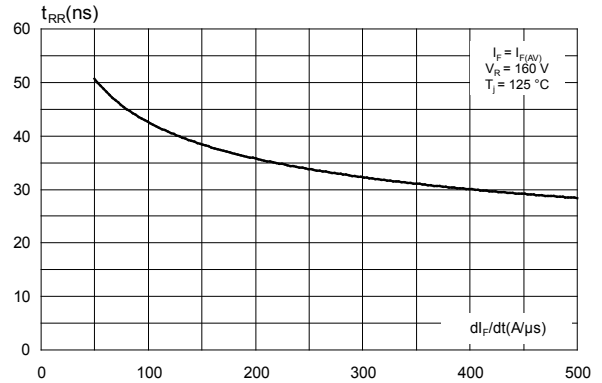

Figure 7. Reverse recovery charges versus di_F/dt (typical values)

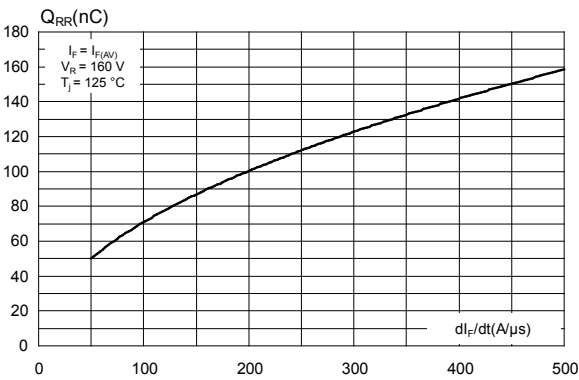

Figure 8. Reverse recovery softness factor versus di_F/dt (typical values)

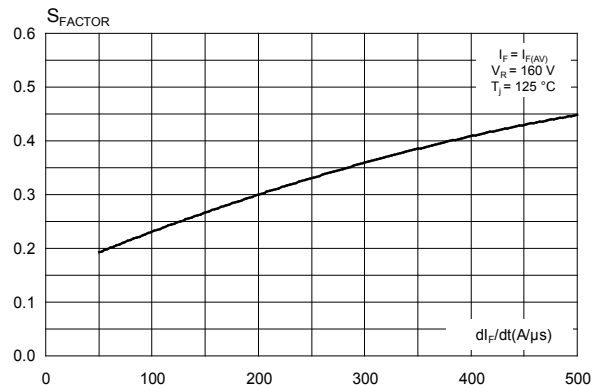

Figure 9. Relative variations of dynamic parameters versus junction temperature

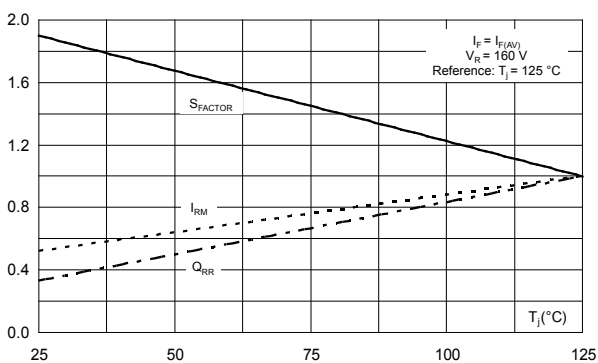

Figure 10. Junction capacitance versus reverse voltage applied (typical values)

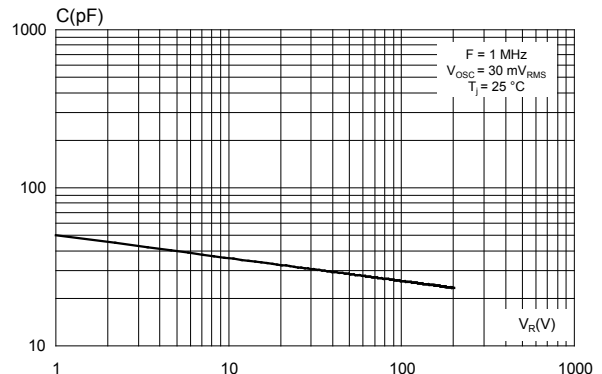

Figure 11. Thermal resistance junction to ambient versus copper surface under tab (typical values, epoxy printed board FR4, $e_{Cu} = 35 \mu m$) (PSMC (TO-277A))



2 Package information

In order to meet environmental requirements, ST offers these devices in different grades of ECOPACK® packages, depending on their level of environmental compliance. ECOPACK® specifications, grade definitions and product status are available at: www.st.com. ECOPACK® is an ST trademark.

2.1 PSMC (TO-277A) package information

- Epoxy meets UL94,V0
- Cooling method : by conduction (C)

Figure 12. PSMC (TO-277A) package outline

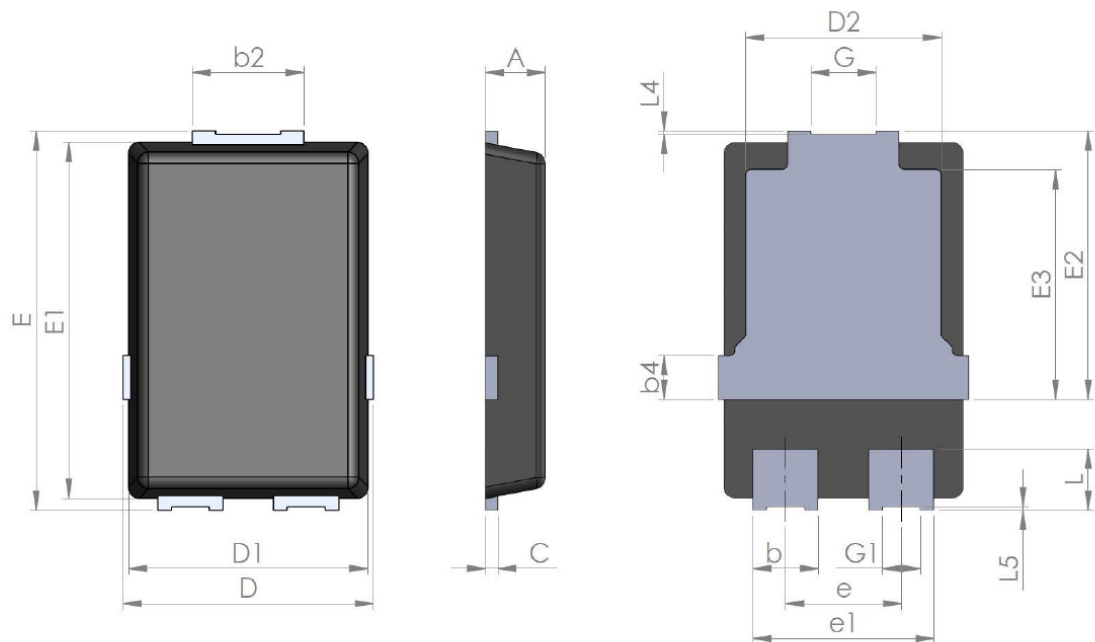
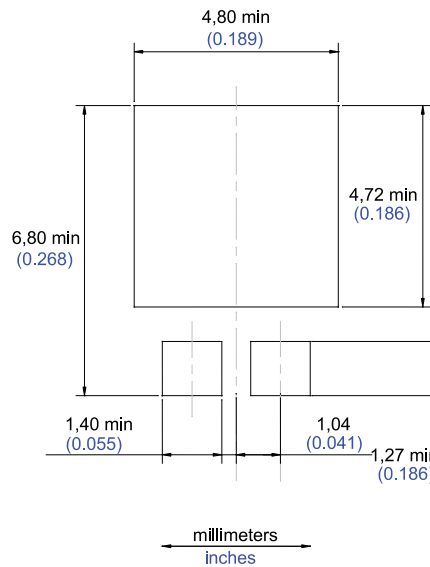

Table 5. PSMC (TO-277A) package mechanical data

Ref.	Dimensions					
	Millimeters			Inches (for reference only)		
	Min.	Typ.	Max.	Min.	Typ.	Max.
A	1.00	1.10	1.20	0.039	0.043	0.047
b	1.05	1.20	1.35	0.041	0.047	0.053
b2	1.90	2.05	2.20	0.075	0.081	0.087
b4		0.75			0.029	
C	0.15	0.23	0.40	0.006	0.009	0.016
D	4.45	4.60	4.75	0.175	0.181	0.187
D1	4.25	4.40	4.45	0.167	0.173	0.175
D2	3.40	3.60	3.70	0.134	0.142	0.146

Ref.	Dimensions					
	Millimeters			Inches (for reference only)		
	Min.	Typ.	Max.	Min.	Typ.	Max.
E	6.35	6.50	6.65	0.250	0.256	0.262
E1	6.05	6.10	6.15	0.238	0.240	0.242
E2	4.50	4.60	4.70	0.177	0.181	0.185
E3		3.94			1.55	
e		2.13			0.084	
e1		3.33			0.131	
G		1.20			0.047	
G1		0.70			0.027	
L	0.90	1.05	1.24	0.035	0.041	0.049
L4	0.02			0.0008		
L5	0.02			0.0008		

Figure 13. PSMC (TO-277A) package footprint in mm (in inches)



3 Ordering information

Table 6. Ordering information

Order code	Marking	Package	Weight	Base qty.	Delivery mode
STTH802SF	TH802	PSMC (TO-277A)	90 mg	6000	Tape and Reel

Revision history

Table 7. Document revision history

Date	Version	Changes
04-Jul-2018	1	Initial release.
10-Jul-2018	2	Updated Table 1. Absolute ratings (limiting values at 25 °C, unless otherwise specified, anode terminals short-circuited).

IMPORTANT NOTICE – PLEASE READ CAREFULLY

STMicroelectronics NV and its subsidiaries (“ST”) reserve the right to make changes, corrections, enhancements, modifications, and improvements to ST products and/or to this document at any time without notice. Purchasers should obtain the latest relevant information on ST products before placing orders. ST products are sold pursuant to ST’s terms and conditions of sale in place at the time of order acknowledgement.

Purchasers are solely responsible for the choice, selection, and use of ST products and ST assumes no liability for application assistance or the design of Purchasers’ products.

No license, express or implied, to any intellectual property right is granted by ST herein.

Resale of ST products with provisions different from the information set forth herein shall void any warranty granted by ST for such product.

ST and the ST logo are trademarks of ST. All other product or service names are the property of their respective owners.

Information in this document supersedes and replaces information previously supplied in any prior versions of this document.

© 2018 STMicroelectronics – All rights reserved