

## High Voltage, Phase Control Thyristor, 12 A

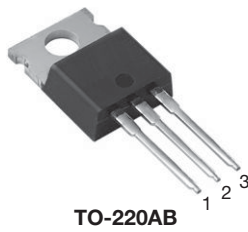

TO-220AB

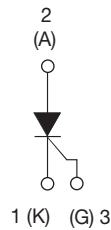

### FEATURES

- AEC-Q101 qualified
- Meets JESD 201 class 1A whisker test
- Flexible solution for reliable AC power rectification
- Easy control peak current at charger power up to reduce passive / electromechanical components
- Material categorization: for definitions of compliance please see [www.vishay.com/doc?99912](http://www.vishay.com/doc?99912)



**RoHS**  
COMPLIANT  
HALOGEN  
**FREE**

### APPLICATIONS

- On-board and off-board EV / HEV battery chargers
- Renewable energy inverters

### DESCRIPTION

The VS-12TTS08HM3 high voltage series of silicon controlled rectifiers are specifically designed for medium power switching and phase control applications.

PRIMARY CHARACTERISTICS	
$I_{T(AV)}$	8 A
$V_{DRM}/V_{RRM}$	800 V
$V_{TM}$	1.2 V
$I_{GT}$	15 mA
$T_J$	-40 to +125 °C
Package	TO-220AB
Circuit configuration	Single SCR

OUTPUT CURRENT IN TYPICAL APPLICATIONS			
APPLICATIONS	SINGLE-PHASE BRIDGE	THREE-PHASE BRIDGE	UNITS
Capacitive input filter $T_A = 55$ °C, $T_J = 125$ °C, common heatsink of 1 °C/W	13.5	17	A

MAJOR RATINGS AND CHARACTERISTICS			
PARAMETER	TEST CONDITIONS	VALUES	UNITS
$I_{T(AV)}$	Sinusoidal waveform	8	A
$I_{T(RMS)}$		12.5	
$V_{RRM}/V_{DRM}$		800	V
$I_{TSM}$		110	A
$V_T$	8 A, $T_J = 25$ °C	1.2	V
dV/dt		150	V/μs
dI/dt		100	A/μs
$T_J$	Range	-40 to +125	°C

VOLTAGE RATINGS			
PART NUMBER	$V_{RRM}$ , MAXIMUM PEAK REVERSE VOLTAGE V	$V_{DRM}$ , MAXIMUM PEAK DIRECT VOLTAGE V	$I_{RRM} / I_{DRM}$ AT 125 °C mA
VS-12TTS08HM3	800	800	5.0



ABSOLUTE MAXIMUM RATINGS					
PARAMETER	SYMBOL	TEST CONDITIONS	VALUES	UNITS	
Maximum average on-state current	$I_{T(AV)}$	$T_C = 108\text{ }^\circ\text{C}$ , 180° conduction, half sine wave	8	A	
Maximum RMS on-state current	$I_{T(RMS)}$		12.5		
Maximum peak one-cycle non-repetitive surge current	$I_{TSM}$	10 ms sine pulse, rated $V_{RRM}$ applied, $T_J = 125\text{ }^\circ\text{C}$	95		
		10 ms sine pulse, no voltage reapplied, $T_J = 125\text{ }^\circ\text{C}$	110		
Maximum $I^2t$ for fusing	$I^2t$	10 ms sine pulse, rated $V_{RRM}$ applied, $T_J = 125\text{ }^\circ\text{C}$	45	$A^2s$	
		10 ms sine pulse, no voltage reapplied, $T_J = 125\text{ }^\circ\text{C}$	64		
Maximum $I^2\sqrt{t}$ for fusing	$I^2\sqrt{t}$	$t = 0.1\text{ ms to } 10\text{ ms}$ , no voltage reapplied, $T_J = 125\text{ }^\circ\text{C}$	640	$A^2\sqrt{s}$	
Maximum on-state voltage drop	$V_{TM}$	8 A, $T_J = 25\text{ }^\circ\text{C}$	1.2	V	
On-state slope resistance	$r_t$	$T_J = 125\text{ }^\circ\text{C}$	16.2	$m\Omega$	
Threshold voltage	$V_{T(TO)}$		0.87	V	
Maximum reverse and direct leakage current	$I_{RM}/I_{DM}$	$V_R = \text{rated } V_{RRM} / V_{DRM}$	$T_J = 25\text{ }^\circ\text{C}$	0.05	mA
			$T_J = 125\text{ }^\circ\text{C}$	5.0	
Typical holding current	$I_H$	Anode supply = 6 V, resistive load, initial $I_T = 1\text{ A}$ , $T_J = 25\text{ }^\circ\text{C}$	30		
Typical latching current	$I_L$	Anode supply = 6 V, resistive load, $T_J = 25\text{ }^\circ\text{C}$	50		
Maximum rate of rise of off-state voltage	$dV/dt$	$T_J = T_J \text{ max.}$ , linear to 80 %, $V_{DRM} = R_g - k = \text{open}$	150	$V/\mu s$	
Maximum rate of rise of turned-on current	$dI/dt$		100	$A/\mu s$	

TRIGGERING				
PARAMETER	SYMBOL	TEST CONDITIONS	VALUES	UNITS
Maximum peak gate power	$P_{GM}$		8.0	W
Maximum average gate power	$P_{G(AV)}$		2.0	
Maximum peak positive gate current	$+I_{GM}$		1.5	A
Maximum peak negative gate voltage	$-V_{GM}$		10	V
Maximum required DC gate current to trigger	$I_{GT}$	Anode supply = 6 V, resistive load, $T_J = -65\text{ }^\circ\text{C}$	20	mA
		Anode supply = 6 V, resistive load, $T_J = 25\text{ }^\circ\text{C}$	15	
		Anode supply = 6 V, resistive load, $T_J = 125\text{ }^\circ\text{C}$	10	
Maximum required DC gate voltage to trigger	$V_{GT}$	Anode supply = 6 V, resistive load, $T_J = -65\text{ }^\circ\text{C}$	1.2	V
		Anode supply = 6 V, resistive load, $T_J = 25\text{ }^\circ\text{C}$	1	
		Anode supply = 6 V, resistive load, $T_J = 125\text{ }^\circ\text{C}$	0.7	
Maximum DC gate voltage not to trigger	$V_{GD}$	$T_J = 125\text{ }^\circ\text{C}$ , $V_{DRM} = \text{rated value}$	0.2	
Maximum DC gate current not to trigger	$I_{GD}$		0.1	mA

SWITCHING				
PARAMETER	SYMBOL	TEST CONDITIONS	VALUES	UNITS
Typical turn-on time	$t_{gt}$	$T_J = 25\text{ }^\circ\text{C}$	0.8	$\mu s$
Typical reverse recovery time	$t_{rr}$	$T_J = 125\text{ }^\circ\text{C}$	3	
Typical turn-off time	$t_q$		100	



THERMAL AND MECHANICAL SPECIFICATIONS				
PARAMETER	SYMBOL	TEST CONDITIONS	VALUES	UNITS
Maximum junction and storage temperature range	$T_J, T_{Stg}$		-40 to +125	°C
Maximum thermal resistance, junction to case	$R_{thJC}$	DC operation	1.5	°C/W
Maximum thermal resistance, junction to ambient	$R_{thJA}$		62	
Typical thermal resistance, case to heatsink	$R_{thCS}$	Mounting surface, smooth, and greased	0.5	
Approximate weight			2	g
			0.07	oz.
Mounting torque	minimum		6 (5)	kgf · cm (lbf · in)
	maximum		12 (10)	
Marking device		Case style TO-220AB	12TTS08H	

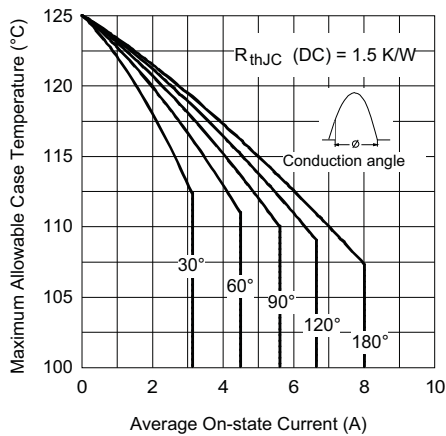

Fig. 1 - Current Rating Characteristics

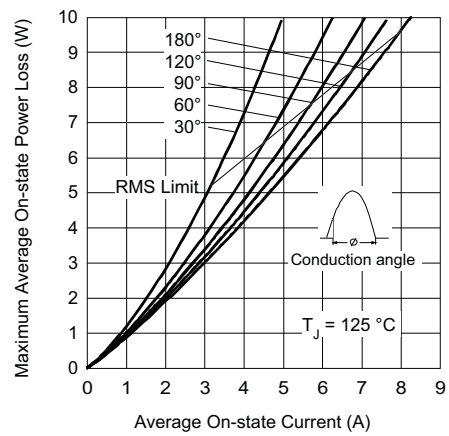

Fig. 3 - On-State Power Loss Characteristics

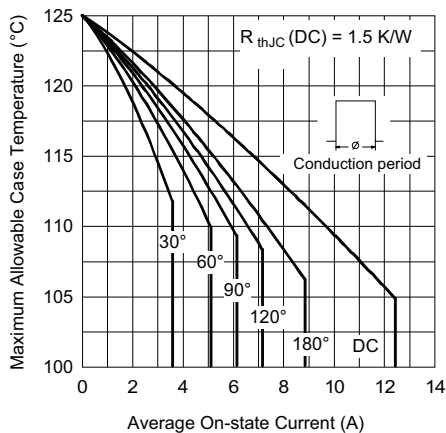

Fig. 2 - Current Rating Characteristics

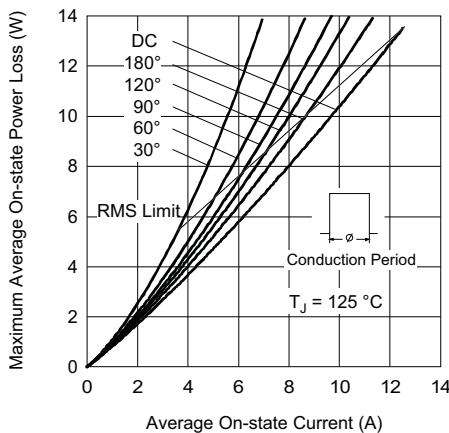

Fig. 4 - On-State Power Loss Characteristics

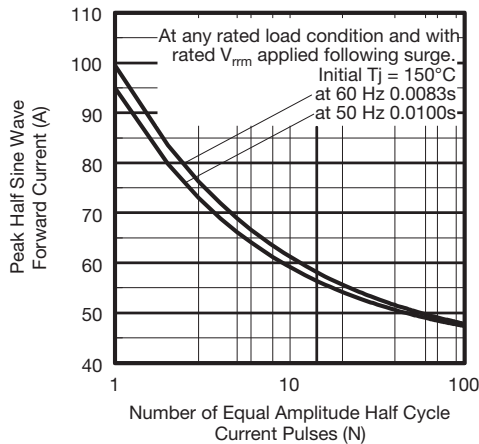

Fig. 5 - Maximum Non-Repetitive Surge Current

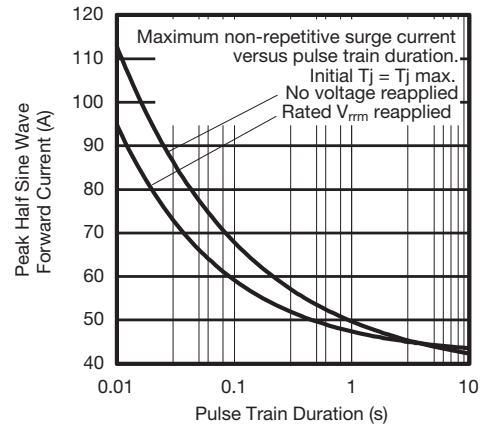

Fig. 6 - Maximum Non-Repetitive Surge Current

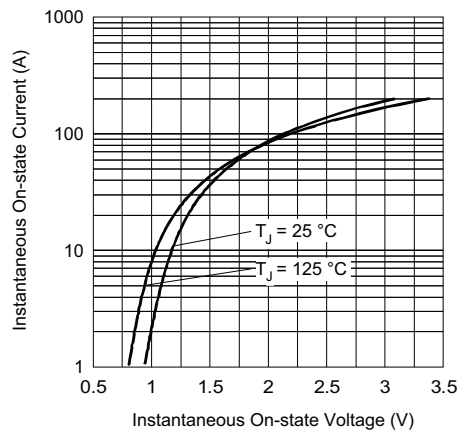

Fig. 7 - On-State Voltage Drop Characteristics

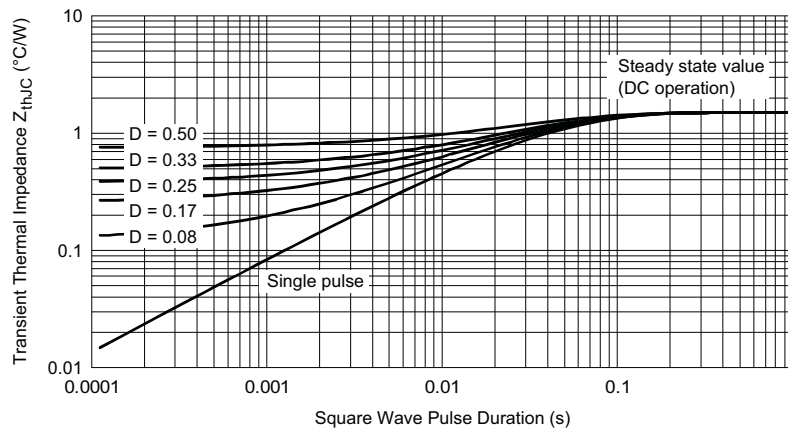
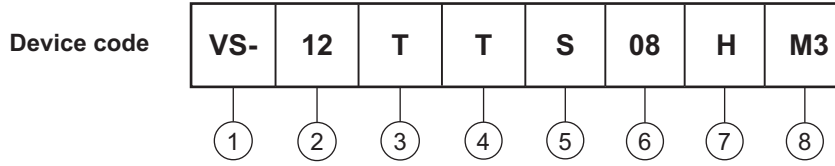

Fig. 8 - Thermal Impedance  $Z_{thJC}$  Characteristics



**ORDERING INFORMATION TABLE**



- 1** - Vishay Semiconductors product
- 2** - Current rating (12.5 A)
- 3** - Circuit configuration:  
T = single thyristor
- 4** - Package:  
T = TO-220
- 5** - Type of silicon:  
S = standard recovery rectifier
- 6** - Voltage rating (08 = 800 V)
- 7** - H = AEC-Q101 qualified
- 8** - Environmental digit:  
M3 = halogen-free, RoHS-compliant, and terminations lead (Pb)-free

<b>ORDERING INFORMATION</b> (Example)			
<b>PREFERRED P/N</b>	<b>QUANTITY PER T/R</b>	<b>MINIMUM ORDER QUANTITY</b>	<b>PACKAGING DESCRIPTION</b>
VS-12TTS08HM3	50	1000	Antistatic plastic tube

<b>LINKS TO RELATED DOCUMENTS</b>	
Dimensions	<a href="http://www.vishay.com/doc?95222">www.vishay.com/doc?95222</a>
Part marking information	<a href="http://www.vishay.com/doc?95028">www.vishay.com/doc?95028</a>

### TO-220AB

#### DIMENSIONS in millimeters and inches

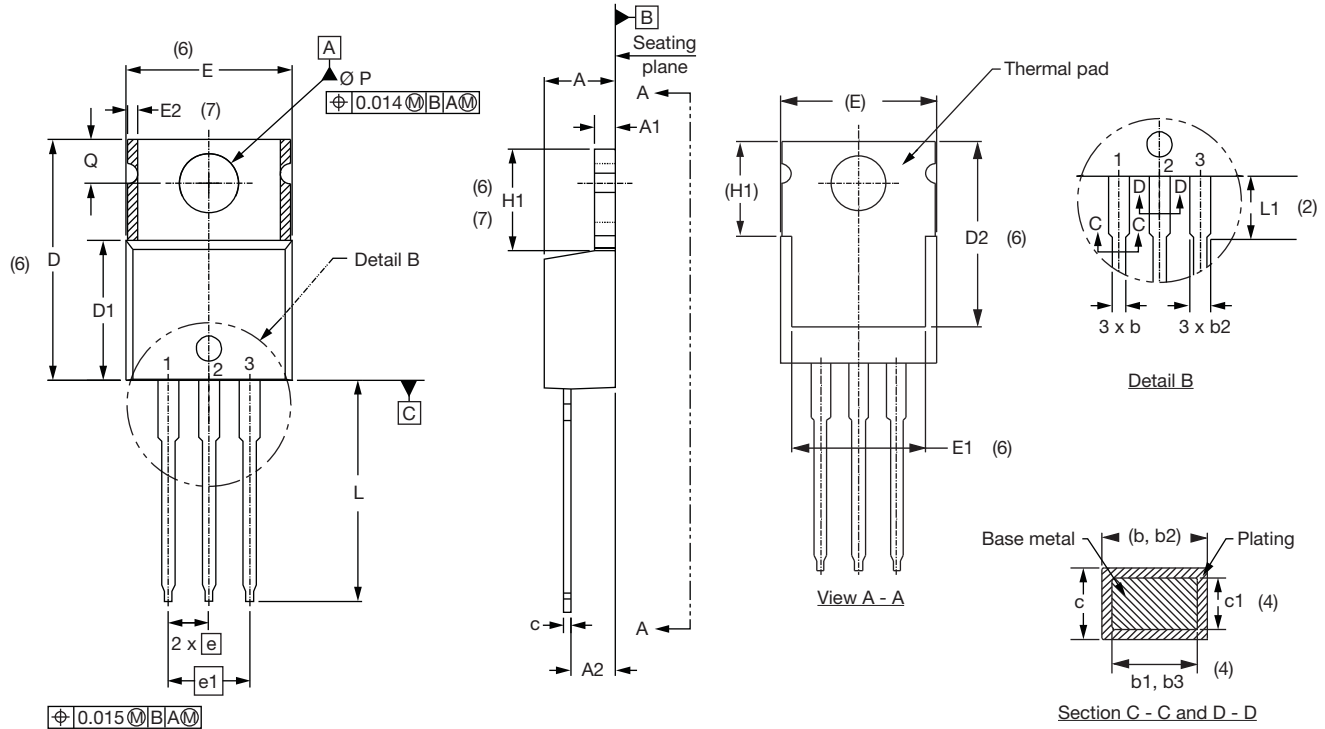

#### Lead assignments

##### Diodes

1. - Anode/open
2. - Cathode
3. - Anode

Conforms to JEDEC outline TO-220AB

SYMBOL	MILLIMETERS		INCHES		NOTES
	MIN.	MAX.	MIN.	MAX.	
A	4.25	4.65	0.167	0.183	
A1	1.14	1.40	0.045	0.055	
A2	2.56	2.92	0.101	0.115	
b	0.69	1.01	0.027	0.040	
b1	0.38	0.97	0.015	0.038	4
b2	1.20	1.73	0.047	0.068	
b3	1.14	1.73	0.045	0.068	4
c	0.36	0.61	0.014	0.024	
c1	0.36	0.56	0.014	0.022	4
D	14.85	15.25	0.585	0.600	3
D1	8.38	9.02	0.330	0.355	
D2	11.68	12.88	0.460	0.507	6

SYMBOL	MILLIMETERS		INCHES		NOTES
	MIN.	MAX.	MIN.	MAX.	
E	10.11	10.51	0.398	0.414	3, 6
E1	6.86	8.89	0.270	0.350	6
E2	-	0.76	-	0.030	7
e	2.41	2.67	0.095	0.105	
e1	4.88	5.28	0.192	0.208	
H1	6.09	6.48	0.240	0.255	6, 7
L	13.52	14.02	0.532	0.552	
L1	3.32	3.82	0.131	0.150	2
Ø P	3.54	3.73	0.139	0.147	
Q	2.60	3.00	0.102	0.118	
θ	90° to 93°		90° to 93°		

#### Notes

- (1) Dimensioning and tolerancing as per ASME Y14.5M-1994
- (2) Lead dimension and finish uncontrolled in L1
- (3) Dimension D, D1 and E do not include mold flash. Mold flash shall not exceed 0.127 mm (0.005") per side. These dimensions are measured at the outermost extremes of the plastic body
- (4) Dimension b1, b3 and c1 apply to base metal only
- (5) Controlling dimensions: inches
- (6) Thermal pad contour optional within dimensions E, H1, D2 and E1
- (7) Dimensions E2 x H1 define a zone where stamping and singulation irregularities are allowed
- (8) Outline conforms to JEDEC TO-220, except A2 (maximum) and D2 (minimum) where dimensions are derived from the actual package outline



## **Disclaimer**

ALL PRODUCT, PRODUCT SPECIFICATIONS AND DATA ARE SUBJECT TO CHANGE WITHOUT NOTICE TO IMPROVE RELIABILITY, FUNCTION OR DESIGN OR OTHERWISE.

Vishay Intertechnology, Inc., its affiliates, agents, and employees, and all persons acting on its or their behalf (collectively, "Vishay"), disclaim any and all liability for any errors, inaccuracies or incompleteness contained in any datasheet or in any other disclosure relating to any product.

Vishay makes no warranty, representation or guarantee regarding the suitability of the products for any particular purpose or the continuing production of any product. To the maximum extent permitted by applicable law, Vishay disclaims (i) any and all liability arising out of the application or use of any product, (ii) any and all liability, including without limitation special, consequential or incidental damages, and (iii) any and all implied warranties, including warranties of fitness for particular purpose, non-infringement and merchantability.

Statements regarding the suitability of products for certain types of applications are based on Vishay's knowledge of typical requirements that are often placed on Vishay products in generic applications. Such statements are not binding statements about the suitability of products for a particular application. It is the customer's responsibility to validate that a particular product with the properties described in the product specification is suitable for use in a particular application. Parameters provided in datasheets and / or specifications may vary in different applications and performance may vary over time. All operating parameters, including typical parameters, must be validated for each customer application by the customer's technical experts. Product specifications do not expand or otherwise modify Vishay's terms and conditions of purchase, including but not limited to the warranty expressed therein.

Except as expressly indicated in writing, Vishay products are not designed for use in medical, life-saving, or life-sustaining applications or for any other application in which the failure of the Vishay product could result in personal injury or death. Customers using or selling Vishay products not expressly indicated for use in such applications do so at their own risk. Please contact authorized Vishay personnel to obtain written terms and conditions regarding products designed for such applications.

No license, express or implied, by estoppel or otherwise, to any intellectual property rights is granted by this document or by any conduct of Vishay. Product names and markings noted herein may be trademarks of their respective owners.