

# NRVTS5100ETFS

## Trench Surface Mount Schottky Rectifier

This  $\mu$ 8FL flat lead Trench Schottky rectifier provides fast switching performance with soft recovery in a compact thermally efficient package. Its compact footprint makes it ideally suited to portable and automotive applications where board space is at a premium. Its low profile makes it a good option for flat panel display and other applications with limited vertical clearance. The device offers low leakage over temperature making it a good match for applications requiring low quiescent current.

### Features

- Fast Soft Switching for Reduced EMI and Higher Efficiency
- Low Profile – Maximum Height of 1.1 mm
- Small Footprint – Footprint Area of 13.5 mm<sup>2</sup>
- NRV Prefix for Automotive and Other Applications Requiring Unique Site and Control Change Requirements; AEC-Q101 Qualified and PPAP Capable
- These Devices are Pb-Free, Halogen Free/BFR Free and are RoHS Compliant

### Mechanical Characteristics:

- Case: Molded Epoxy
- Epoxy Meets UL 94 V-0 @ 0.125 in
- Weight: 95 mg (Approximately)
- Lead and Mounting Surface Temperature for Soldering Purposes: 260°C Maximum for 10 Seconds
- MSL 1

### Applications

- Switching Power Supplies including Mini-adapters and Displays
- Instrumentation
- Engine Control Recirculation Diodes
- Freewheeling Diode Where Space is at a Premium



**ON Semiconductor®**

[www.onsemi.com](http://www.onsemi.com)

## TRENCH SCHOTTKY RECTIFIER 5.0 AMPERE 100 VOLTS



**WDFN8  
( $\mu$ 8FL)  
CASE 511AB  
FLAT LEAD**

### MARKING DIAGRAM

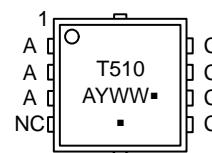

T510 = Specific Device Code  
A = Assembly Location  
Y = Year  
WW = Work Week  
▪ = Pb-Free Package

(Note: Microdot may be in either location)

### ORDERING INFORMATION

Device	Package	Shipping†
NRVTS5100ETFSTAG	WDFN8 (Pb-Free)	1500 / Tape & Reel
NRVTS5100ETFSWFTAG		
NRVTS5100ETFSTWG	WDFN8 (Pb-Free)	5000 / Tape & Reel
NRVTS5100ETFSWFTWG		

†For information on tape and reel specifications, including part orientation and tape sizes, please refer to our Tape and Reel Packaging Specification Brochure, BRD8011/D.

# NRVTS5100ETFS

## MAXIMUM RATINGS

Rating	Symbol	Value	Unit
Peak Repetitive Reverse Voltage Working Peak Reverse Voltage DC Blocking Voltage	$V_{RRM}$ $V_{RWM}$ $V_R$	100	V
Average Rectified Forward Current ( $T_L = TBD^{\circ}C$ )	$I_O$	5.0	A
Peak Repetitive Forward Current (Rated $V_R$ , Square Wave, 20 kHz) $T_L = 161^{\circ}C$	$I_{FRM}$	5.6	A
Non-Repetitive Peak Surge Current (Surge Applied at Rated Load Conditions Halfwave, Single Phase, 60 Hz)	$I_{FSM}$	80	A
Storage Temperature Range	$T_{stg}$	-65 to +175	$^{\circ}C$
Operating Junction Temperature	$T_J$	-65 to +175	$^{\circ}C$

Stresses exceeding those listed in the Maximum Ratings table may damage the device. If any of these limits are exceeded, device functionality should not be assumed, damage may occur and reliability may be affected.

## THERMAL CHARACTERISTICS

Characteristic	Symbol	Value	Unit
Thermal Resistance, Junction-to-Tab (Note 1)	$\Psi_{JCT}$	3.3	$^{\circ}C/W$
Thermal Resistance, Junction-to-Ambient (Note 1)	$R_{\theta JA}$	50.2	$^{\circ}C/W$

1. 1 inch square pad size (1 × 0.5 inch) for each lead on FR4 board.

## ELECTRICAL CHARACTERISTICS

Characteristic	Symbol	Typ	Max	Unit
Instantaneous Forward Voltage (Note 1) ( $i_F = 5$ Amps, $T_J = 25^{\circ}C$ )  ( $i_F = 5$ Amps, $T_J = 125^{\circ}C$ )	$V_F$	0.95  0.70	1.00  0.80	V
Reverse Current (Note 1) (Rated dc Voltage, $T_J = 25^{\circ}C$ ) (Rated dc Voltage, $T_J = 125^{\circ}C$ )	$i_R$	1.50 1.29	50 7.5	$\mu A$ mA
Diode Capacitance (Rated dc Voltage, $T_J = 25^{\circ}C$ , $f = 1$ MHz)	$C_d$	26.5		pF

Product parametric performance is indicated in the Electrical Characteristics for the listed test conditions, unless otherwise noted. Product performance may not be indicated by the Electrical Characteristics if operated under different conditions.

1. Pulse Test: Pulse Width = 300  $\mu s$ , Duty Cycle  $\leq 2.0\%$ .

# NRVTS5100ETF5

## TYPICAL CHARACTERISTICS

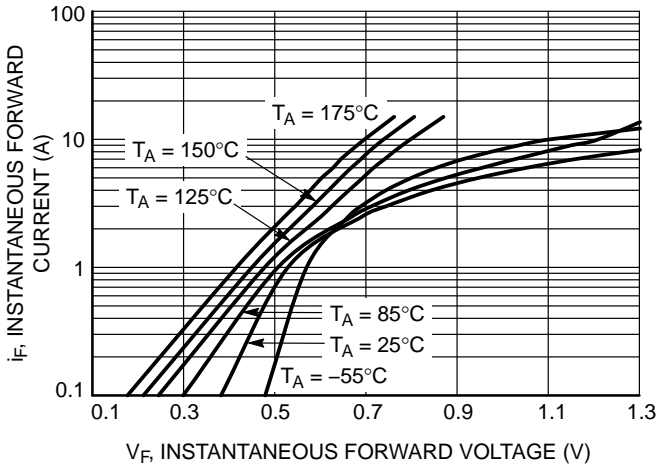

**Figure 1. Typical Instantaneous Forward Characteristics**

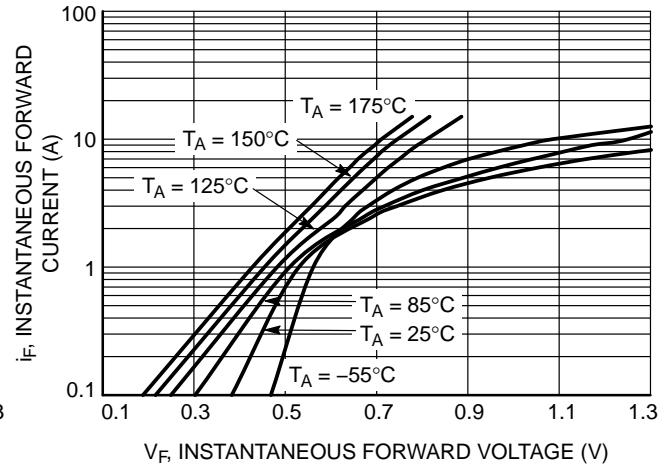

**Figure 2. Maximum Instantaneous Forward Characteristics**

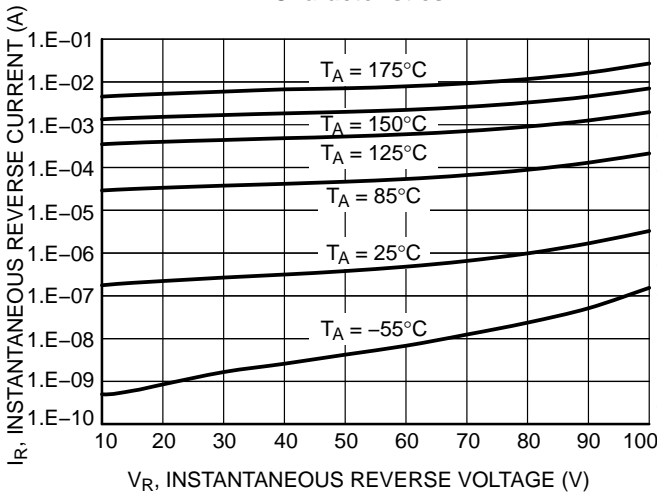

**Figure 3. Typical Reverse Characteristics**

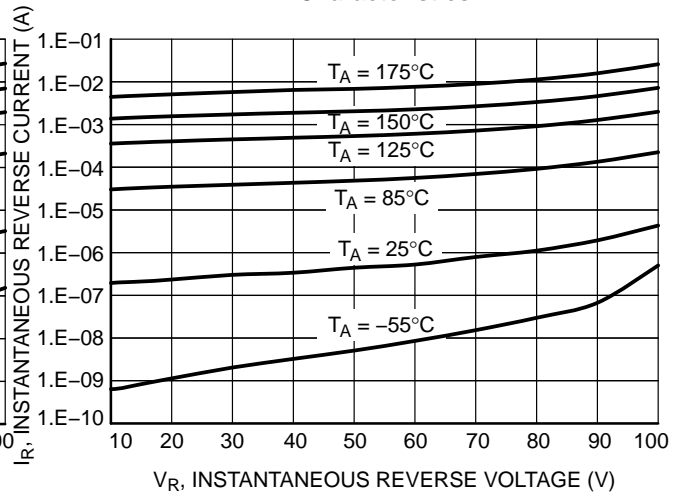

**Figure 4. Maximum Reverse Characteristics**

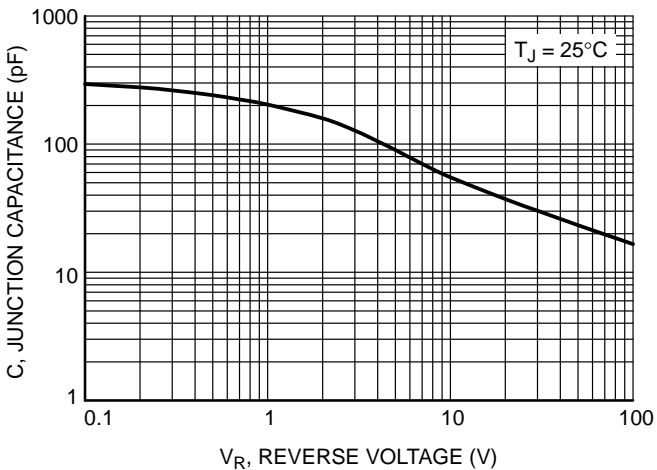

**Figure 5. Typical Junction Capacitance**

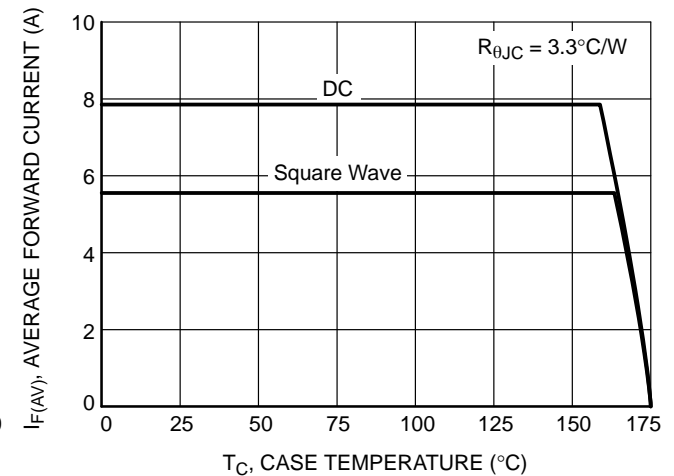

**Figure 6. Current Derating per Diode**

# NRVTS5100ETFS

## TYPICAL CHARACTERISTICS

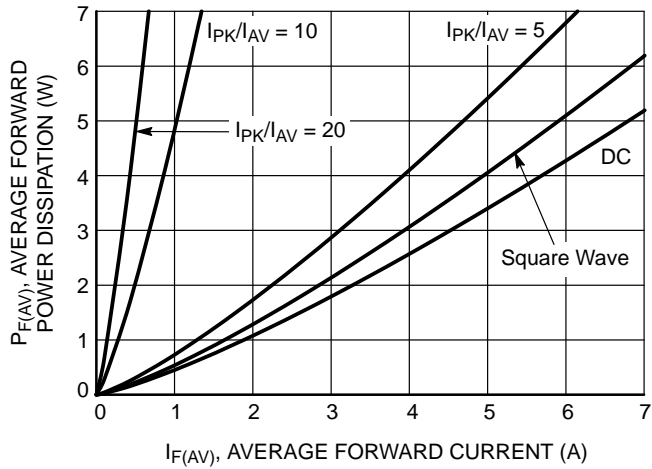

Figure 7. Forward Power Dissipation

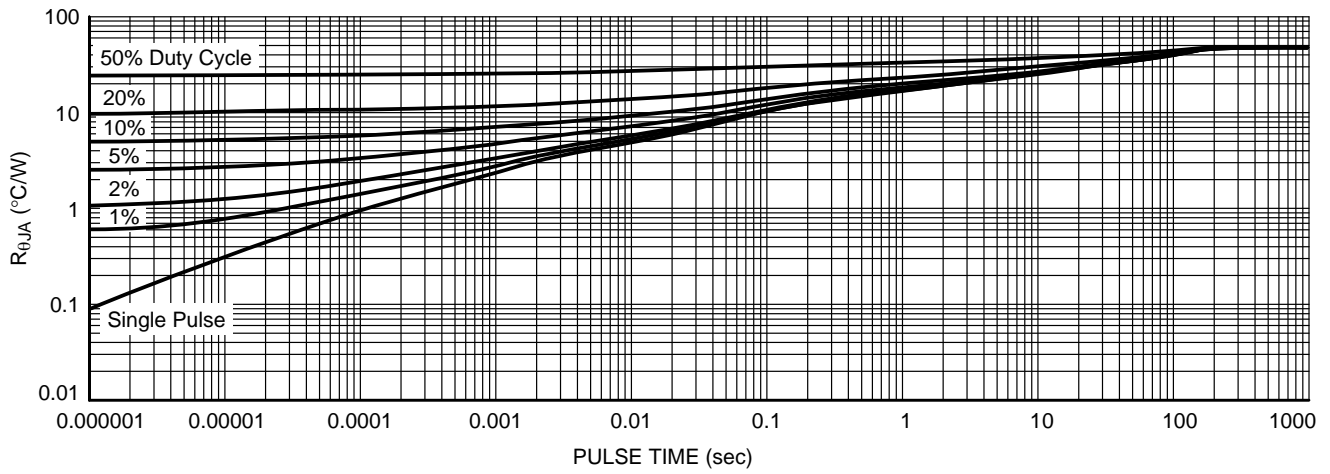
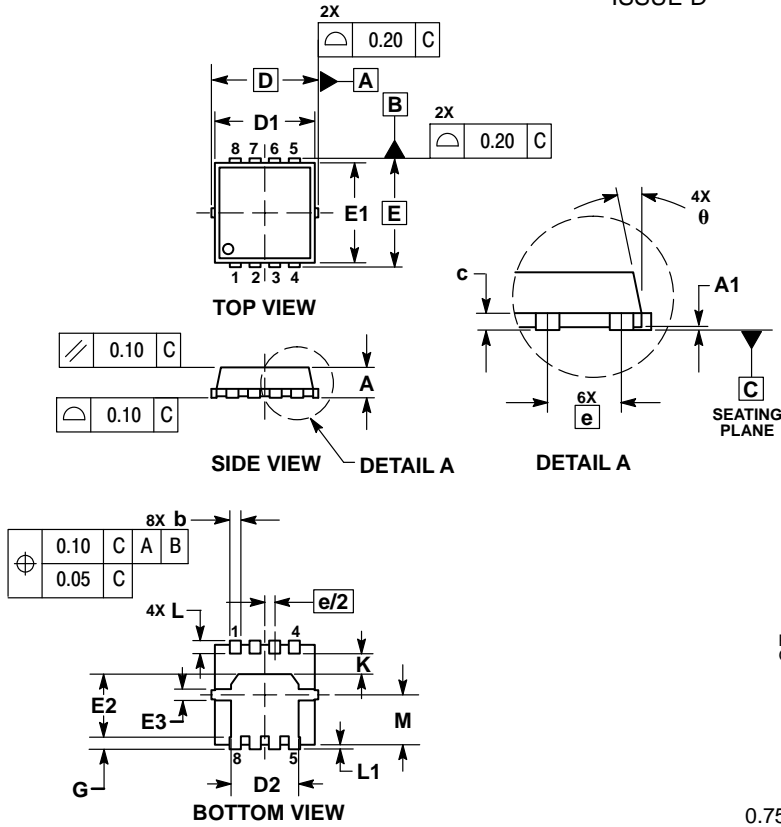

Figure 8. Thermal Characteristics

# NRVTS5100ETFS

## PACKAGE DIMENSIONS

WDFN8 3.3x3.3, 0.65P  
CASE 511AB  
ISSUE D



- NOTES:  
1. DIMENSIONING AND TOLERANCING PER ASME Y14.5M, 1994.  
2. CONTROLLING DIMENSION: MILLIMETERS.  
3. DIMENSION D1 AND E1 DO NOT INCLUDE MOLD FLASH PROTRUSIONS OR GATE BURRS.

DIM	MILLIMETERS			INCHES		
	MIN	NOM	MAX	MIN	NOM	MAX
A	0.70	0.75	0.80	0.028	0.030	0.031
A1	0.00	---	0.05	0.000	---	0.002
b	0.23	0.30	0.40	0.009	0.012	0.016
c	0.15	0.20	0.25	0.006	0.008	0.010
D	3.30 BSC			0.130 BSC		
D1	2.95	3.05	3.15	0.116	0.120	0.124
D2	1.98	2.11	2.24	0.078	0.083	0.088
E	3.30 BSC			0.130 BSC		
E1	2.95	3.05	3.15	0.116	0.120	0.124
E2	1.47	1.60	1.73	0.058	0.063	0.068
E3	0.23	0.30	0.40	0.009	0.012	0.016
e	0.65 BSC			0.026 BSC		
G	0.30	0.41	0.51	0.012	0.016	0.020
K	0.65	0.80	0.95	0.026	0.032	0.037
L	0.30	0.43	0.56	0.012	0.017	0.022
L1	0.06	0.13	0.20	0.002	0.005	0.008
M	1.40	1.50	1.60	0.055	0.059	0.063
θ	0 °	---	12 °	0 °	---	12 °

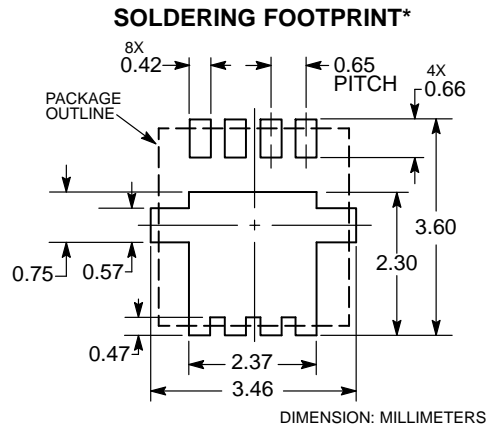

\*For additional information on our Pb-Free strategy and soldering details, please download the ON Semiconductor Soldering and Mounting Techniques Reference Manual, SOLDERRM/D.

ON Semiconductor and are trademarks of Semiconductor Components Industries, LLC dba ON Semiconductor or its subsidiaries in the United States and/or other countries. ON Semiconductor owns the rights to a number of patents, trademarks, copyrights, trade secrets, and other intellectual property. A listing of ON Semiconductor's product/patent coverage may be accessed at [www.onsemi.com/site/pdf/Patent-Marking.pdf](http://www.onsemi.com/site/pdf/Patent-Marking.pdf). ON Semiconductor reserves the right to make changes without further notice to any products herein. ON Semiconductor makes no warranty, representation or guarantee regarding the suitability of its products for any particular purpose, nor does ON Semiconductor assume any liability arising out of the application or use of any product or circuit, and specifically disclaims any and all liability, including without limitation special, consequential or incidental damages. Buyer is responsible for its products and applications using ON Semiconductor products, including compliance with all laws, regulations and safety requirements or standards, regardless of any support or applications information provided by ON Semiconductor. "Typical" parameters which may be provided in ON Semiconductor data sheets and/or specifications can and do vary in different applications and actual performance may vary over time. All operating parameters, including "Typicals" must be validated for each customer application by customer's technical experts. ON Semiconductor does not convey any license under its patent rights nor the rights of others. ON Semiconductor products are not designed, intended, or authorized for use as a critical component in life support systems or any FDA Class 3 medical devices or medical devices with a same or similar classification in a foreign jurisdiction or any devices intended for implantation in the human body. Should Buyer purchase or use ON Semiconductor products for any such unintended or unauthorized application, Buyer shall indemnify and hold ON Semiconductor and its officers, employees, subsidiaries, affiliates, and distributors harmless against all claims, costs, damages, and expenses, and reasonable attorney fees arising out of, directly or indirectly, any claim of personal injury or death associated with such unintended or unauthorized use, even if such claim alleges that ON Semiconductor was negligent regarding the design or manufacture of the part. ON Semiconductor is an Equal Opportunity/Affirmative Action Employer. This literature is subject to all applicable copyright laws and is not for resale in any manner.

### PUBLICATION ORDERING INFORMATION

**LITERATURE FULFILLMENT:**  
Literature Distribution Center for ON Semiconductor  
19521 E. 32nd Pkwy, Aurora, Colorado 80011 USA  
**Phone:** 303-675-2175 or 800-344-3860 Toll Free USA/Canada  
**Fax:** 303-675-2176 or 800-344-3867 Toll Free USA/Canada  
**Email:** [orderlit@onsemi.com](mailto:orderlit@onsemi.com)

**N. American Technical Support:** 800-282-9855 Toll Free  
USA/Canada  
**Europe, Middle East and Africa Technical Support:**  
Phone: 421 33 790 2910

**ON Semiconductor Website:** [www.onsemi.com](http://www.onsemi.com)  
**Order Literature:** <http://www.onsemi.com/orderlit>

For additional information, please contact your local Sales Representative