

Specification

Part No. : **NCP.5820**

Product Name : NB-IoT SMD Ceramic Antenna
For Bands 5, 8 and 20

Features Small size, Small Footprint SMD Antenna

Global NB-IoT Coverage for:

- Band 5, 824-894MHz
- Band 8, 880-960MHz
- Band 20, 791-862mHz

High Efficiency across each Band

Dimensions: 14.1 x 8.3 x 2mm

Automotive IATF16949 Production and Quality Approved

RoHS compliant

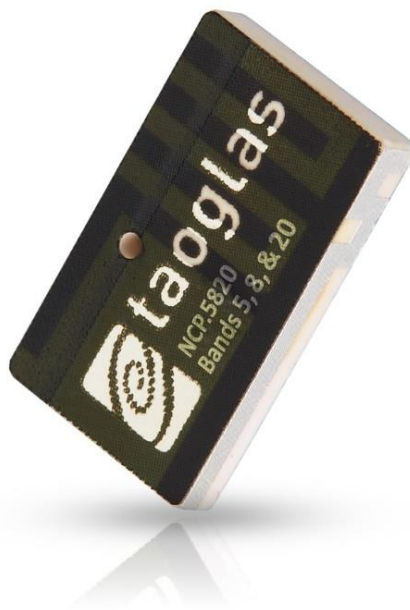

1. Introduction

The evolution of IoT connectivity has seen an urgent need for low power applications that can connect thousands of devices to the internet and Narrowband IoT (NB-IoT) is a new way to facilitate this demand. For a small compact embedded antenna, the Taoglas NCP.5820 fits will fit in many size challenged designs without performance compromises.

The NCP.5820 supports Bands 5 (824-894MHz), 8 (880-960MHz) and 20 (791-862MHz) providing global NB-IoT coverage and demonstrates excellent efficiency across all bands.

The tiny antenna measures just 14.1x8.3x2mm. As it is a surface mount antenna it can be easily integrated into even the smallest of devices. It allows device designers to take advantage of all of the benefits of NB-IoT technology, including reduced power consumption and increased battery life; increased system capacity and spectrum efficiency; and extended coverage in both rural and deep indoors environments all with a very small form factor.

Overall, this antenna is suitable for applications that need to meet the following requirements:

- Small footprint, low profile design factors
- SMT Components for assembly accuracy and reliability
- Excellent antenna efficiency helping to maintain better system gain and hence better device send and receive sensitivity (TRP & TIS)
- Excellent antenna efficiency to aid lower power consumption and increased battery life
- Global coverage for mobility and one global SKU
- 100% quality and performance testing prior to shipping for reliability and consistency
- Mechanical and environmental robustness across the lifetime of the device

For more information or support with integrating this antenna into your device. please contact your regional Taoglas sales office.

2. Specification

| Band 5,8 Electrical | | | |
|------------------------|----------------------------|---------|---------|
| | Band 5 | Band 8 | |
| Frequency (MHz) | 824~894 | 880~960 | |
| Peak Gain (dBi)* | 0.6 | 1.2 | |
| Average Gain (dBi)* | -3.5 | -2.7 | |
| Efficiency (%)* | 53.5 | 60.7 | |
| Return Loss (dB)* | <-4.5 | <-5 | |
| Band 5,8,20 Electrical | | | |
| | Band 5 | Band 8 | Band 20 |
| Frequency (MHz) | 824~894 | 880~960 | 791~862 |
| Peak Gain (dBi)* | 1.1 | 1.7 | -0.3 |
| Average Gain (dBi)* | -3.9 | -3.1 | -4.3 |
| Efficiency (%)* | 47 | 53.1 | 38.7 |
| Return Loss (dB)* | <-4.5 | <-5 | <-4.5 |
| Impedance | 50 Ω | | |
| Maximum Input Power | 5W | | |
| Mechanical | | | |
| Antenna Dimensions | 14.1mm x 8.3mm x 2mm | | |
| Material | Ceramic | | |
| Weight | 0.76 g | | |
| Soldering Type | SMT through Reflow | | |
| Environmental | | | |
| Operation Temperature | -40°C ~ +85°C | | |
| Storage Temperature | -40°C ~ +85°C | | |
| Humidity | Non-condensing 65°C 95% RH | | |

All measurements were conducted with SMT on a 115*35mm evaluation board with 100mm length ground plane and matching circuit.

See EVB drawing and matching circuit diagram in Section 7.

3. Antenna Characteristics

All data was measured on the evaluation board illustrated in Section 7, with the documented matching circuit.

3.1 Return Loss (Band 5,8)

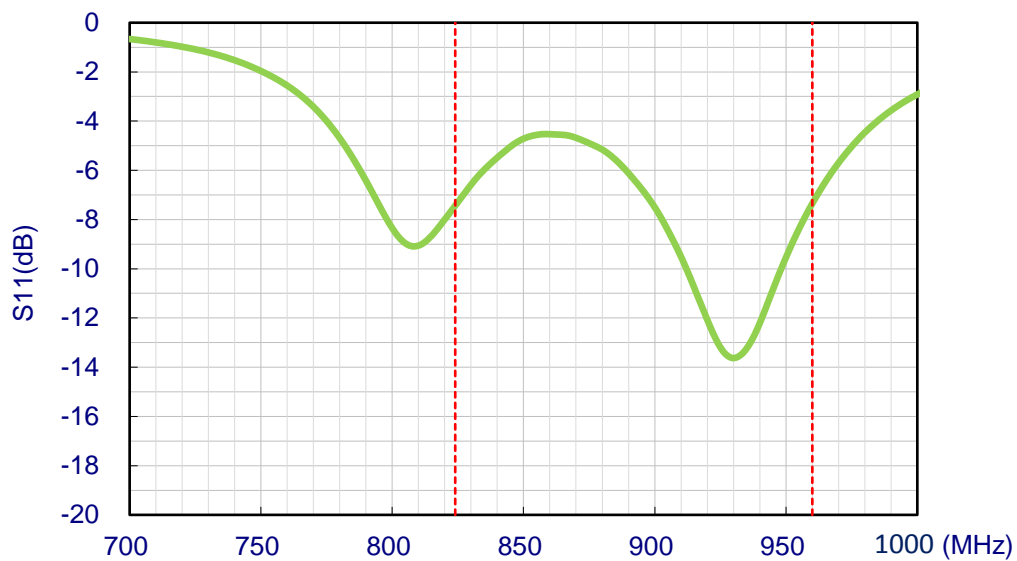

3.2 Efficiency (Band 5,8)

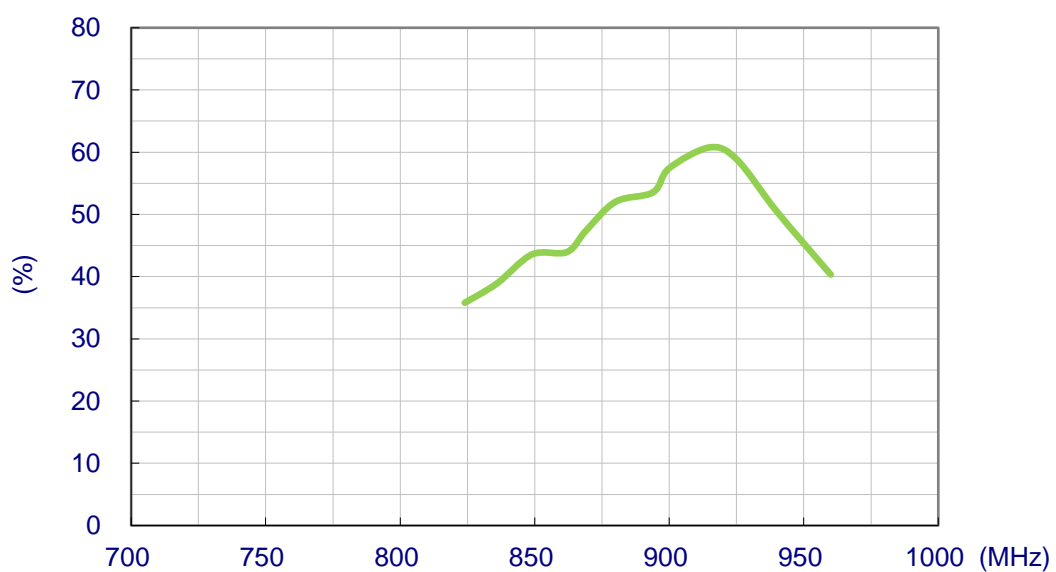

3.3 Average Gain(Band 5,8)

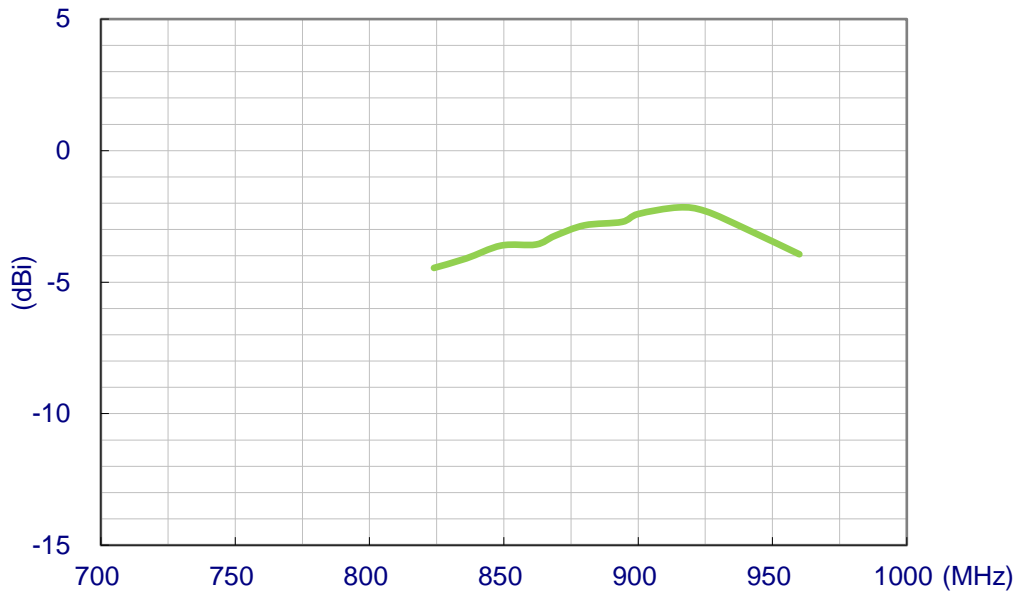

3.4 Peak Gain (Band 5,8)

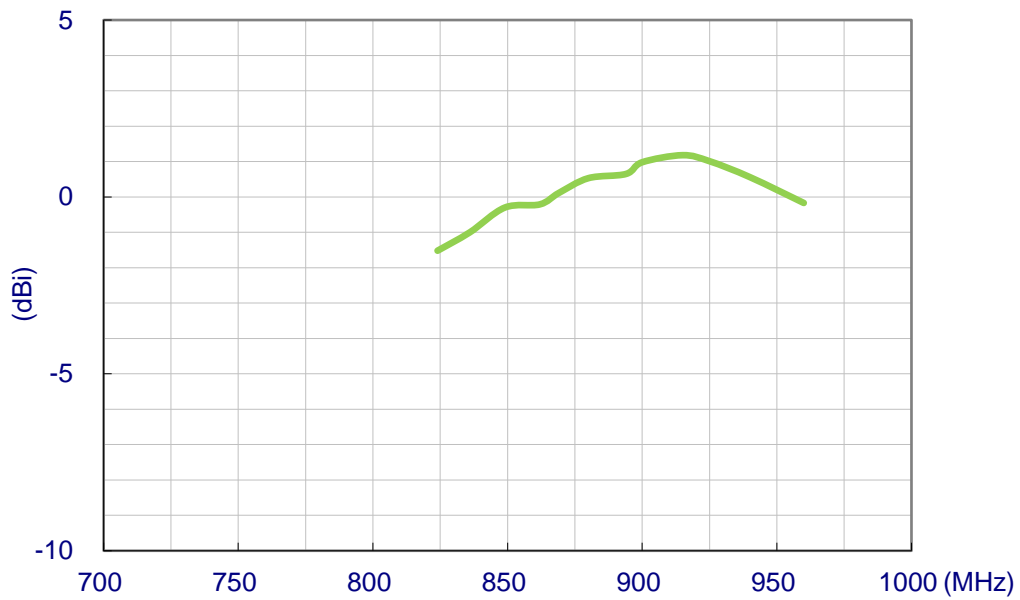

4. Antenna Radiation Patterns

4.1 Antenna Setup (Antenna Test Setup in Anechoic Chamber)

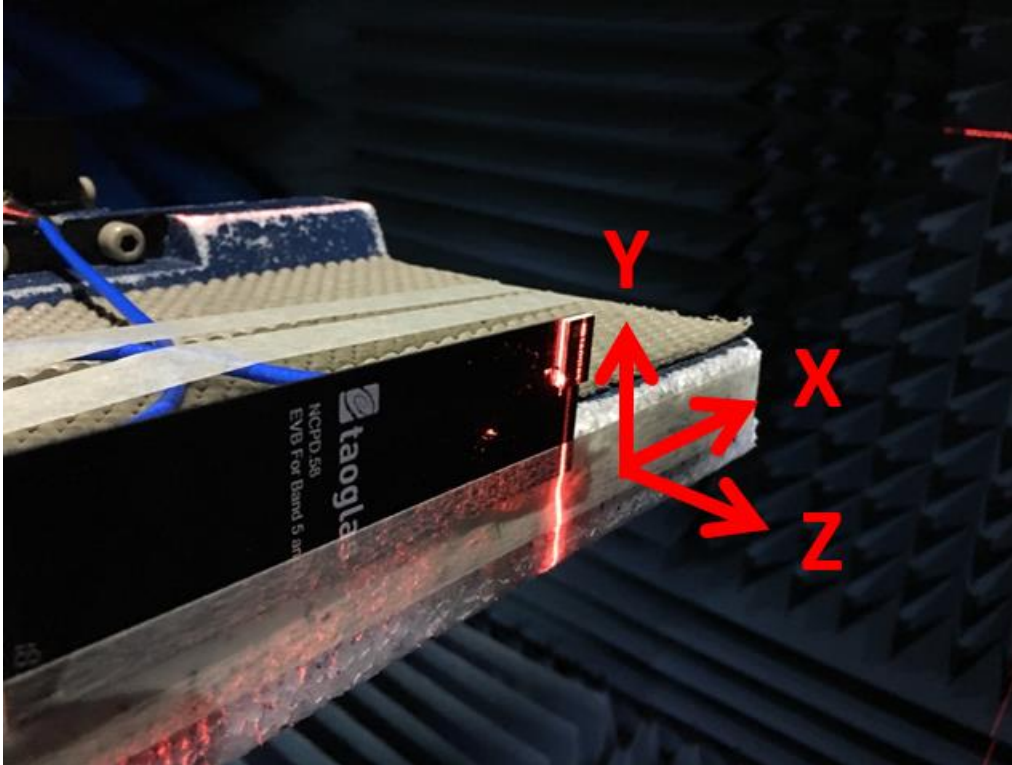

4.2 2D Radiation Patterns (Band 5,8)

XY Plane

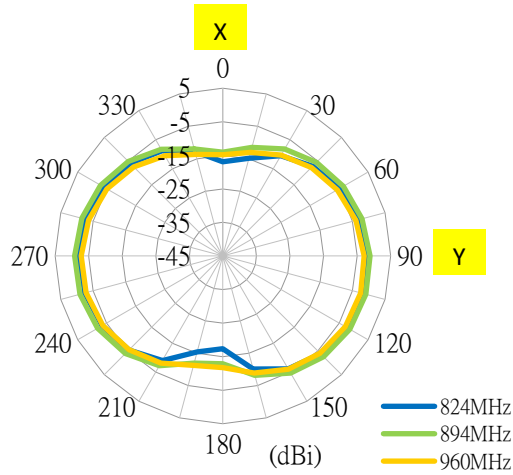

XZ Plane

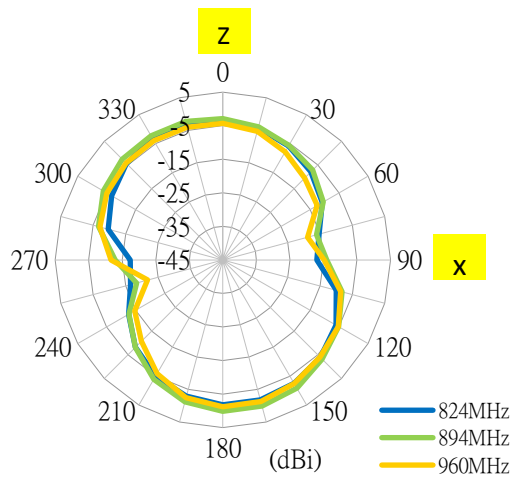

YZ Plane

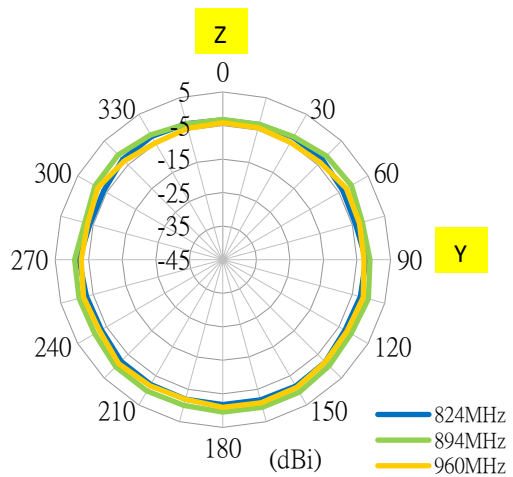

4.3 3D Radiation Patterns (Band 5,8)

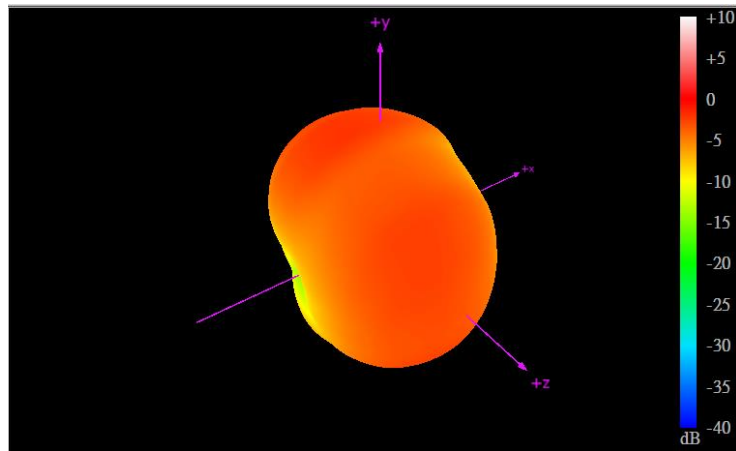

824MHz

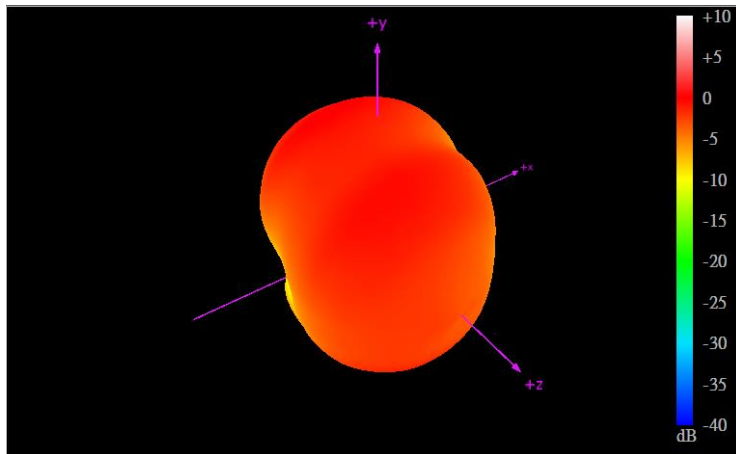

894MHz

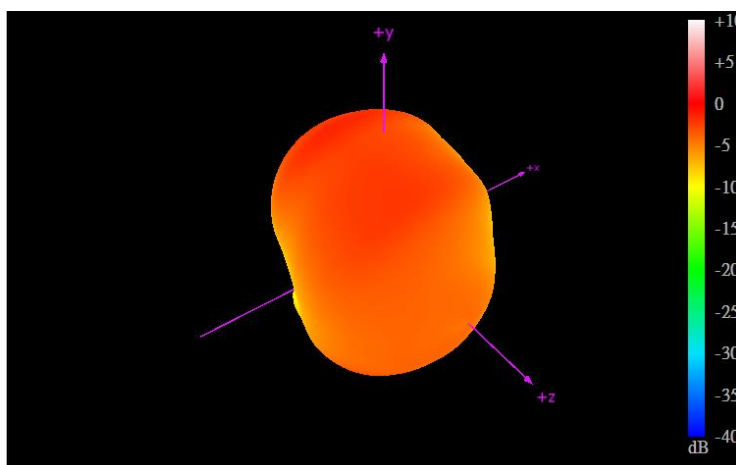

960MHz

5. Antenna Characteristics

All data was measured on the evaluation board illustrated in Section 7, with the documented matching circuit.

5.1 Return Loss (Band 5,8,20)

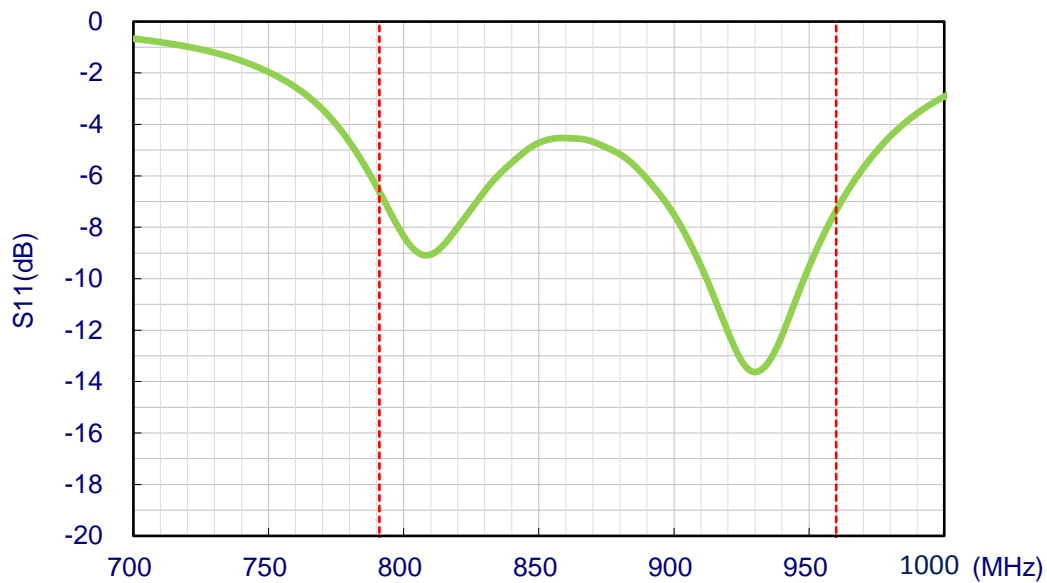

5.2 Efficiency (Band 5,8,20)

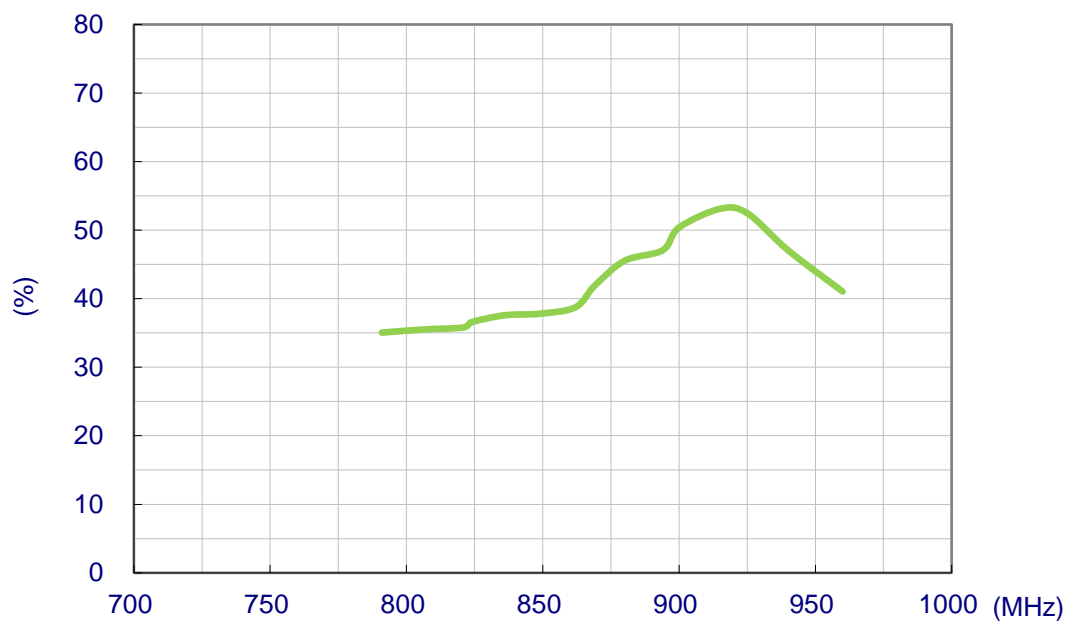

5.3 Average Gain(Band 5,8,20)

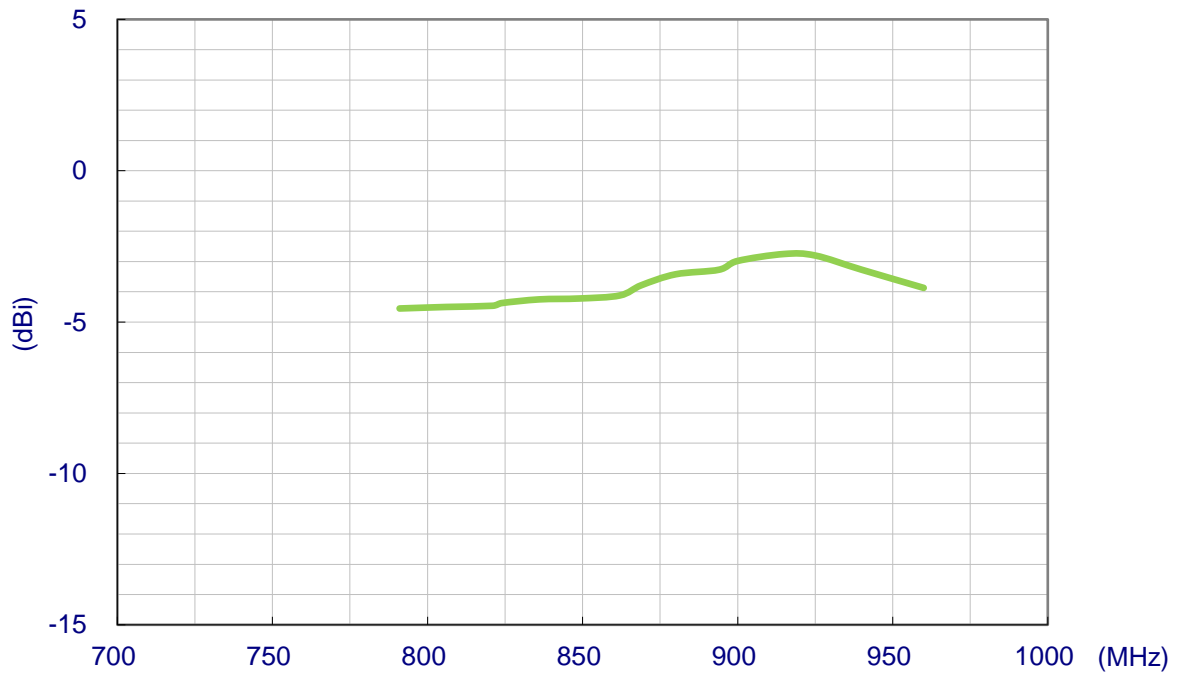

5.4 Peak Gain (Band 5,8,20)

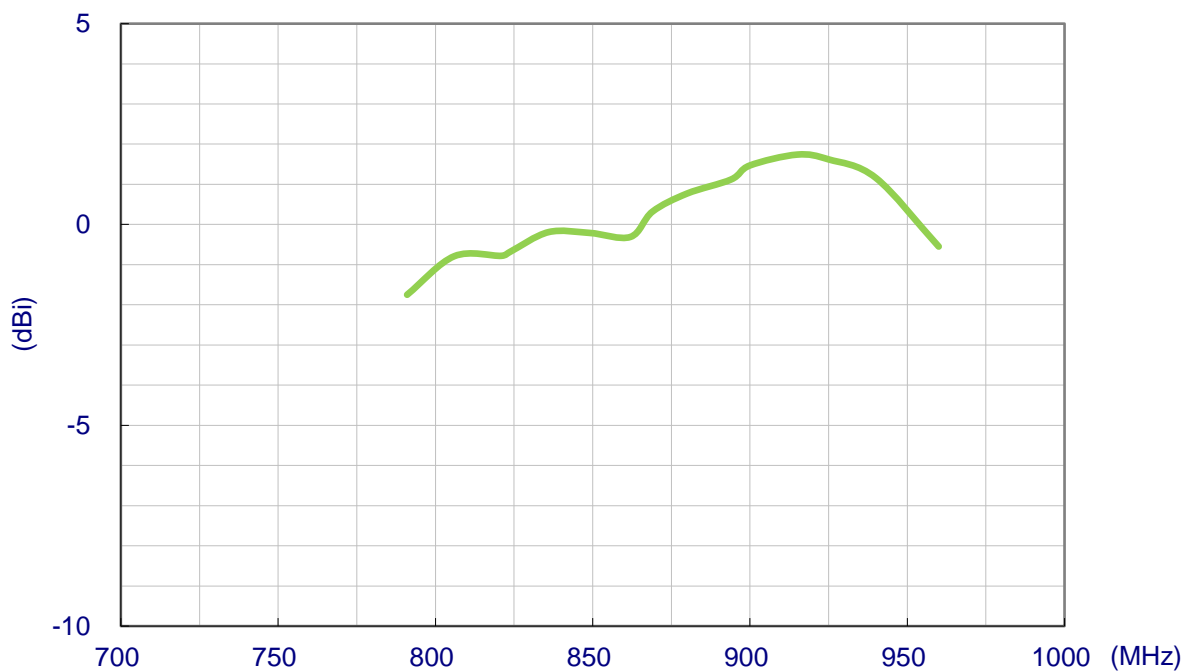

6. Antenna Radiation Patterns

6.1 Antenna Setup (Antenna Test Setup in Anechoic Chamber)

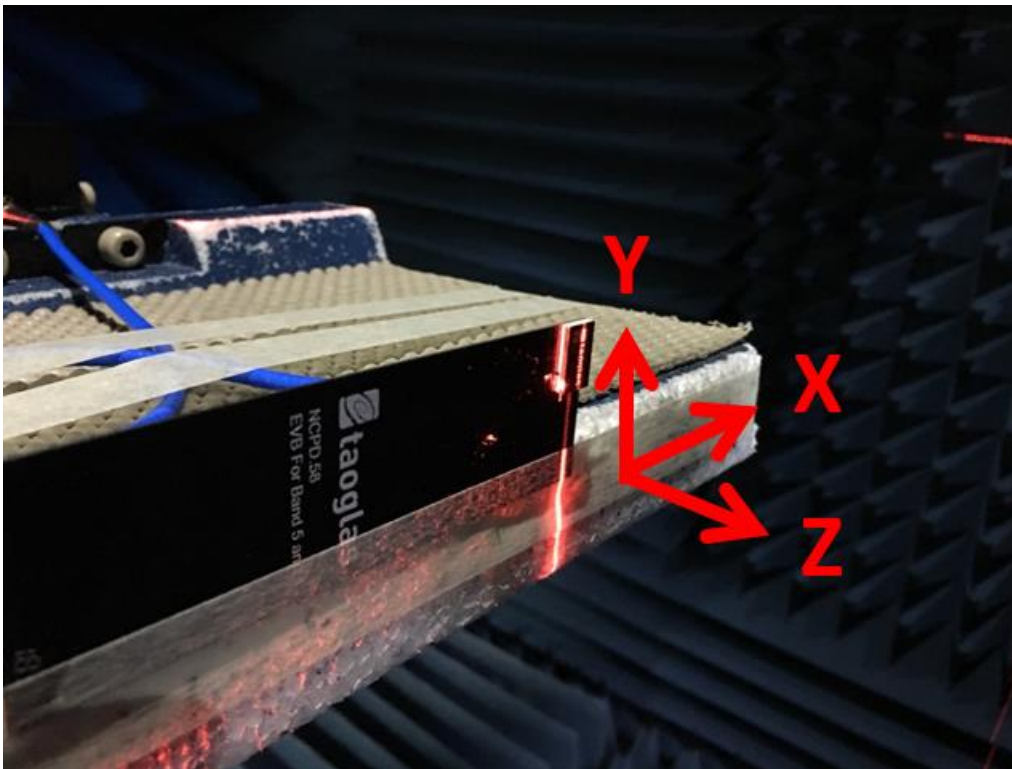

6.2 2D Radiation Patterns (Band 5,8,20)

XY Plane

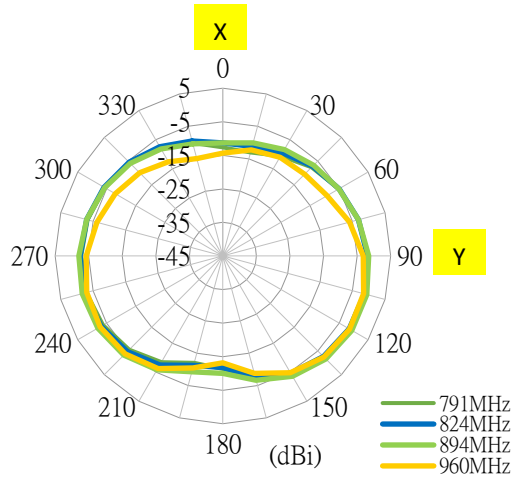

XZ Plane

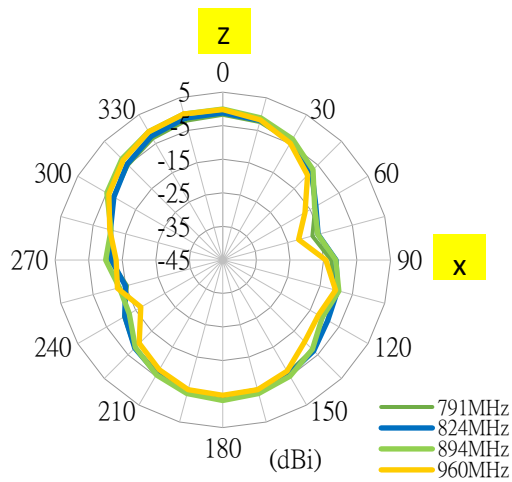

YZ Plane

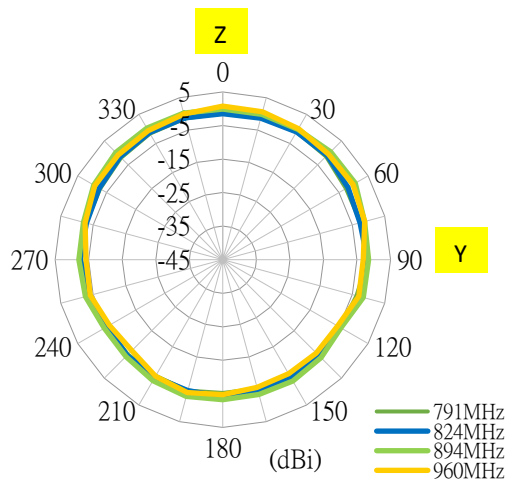

6.3 3D Radiation Patterns (Band 5,8,20)

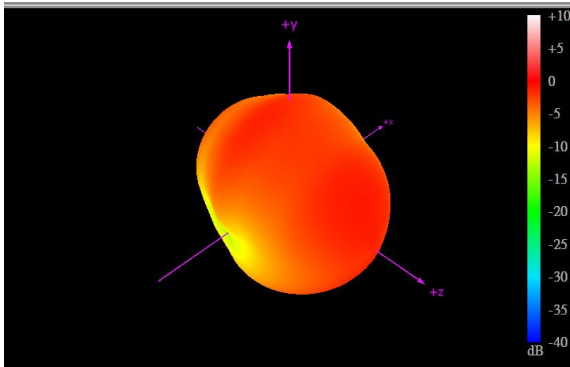

791MHz

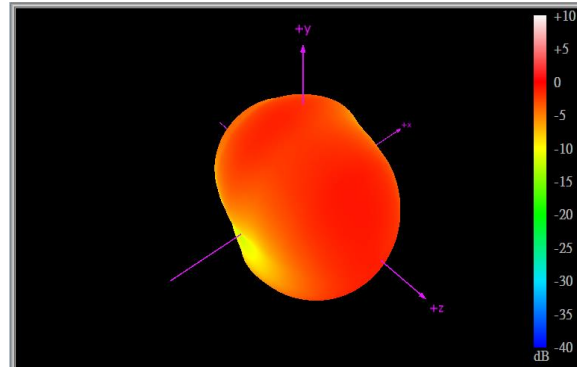

824MHz

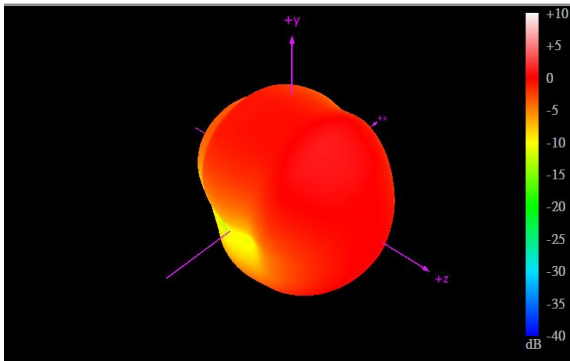

894MHz

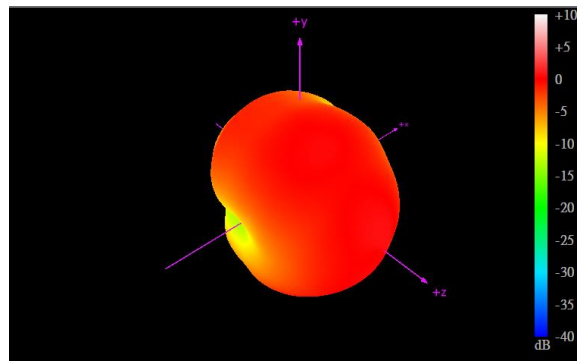

960MHz

7. Mechanical Drawing (Unit: mm)

7.1 Antenna

Front View

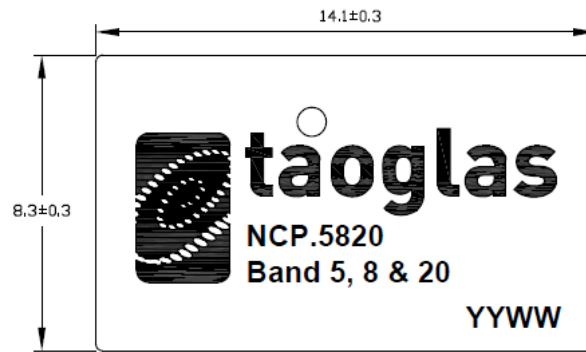

Side View

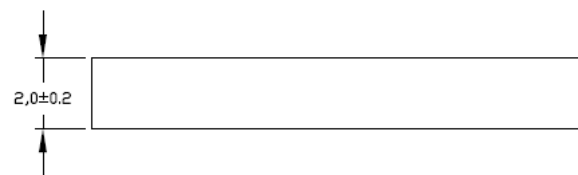

Bottom View

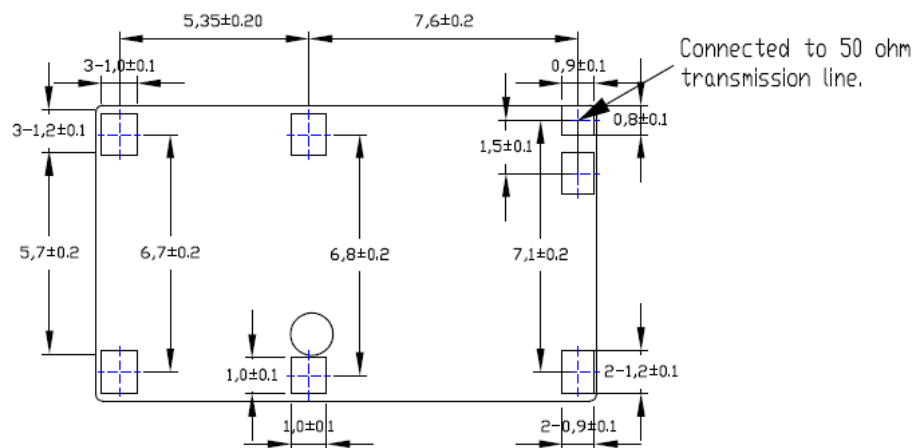

7.2 Evaluation Board

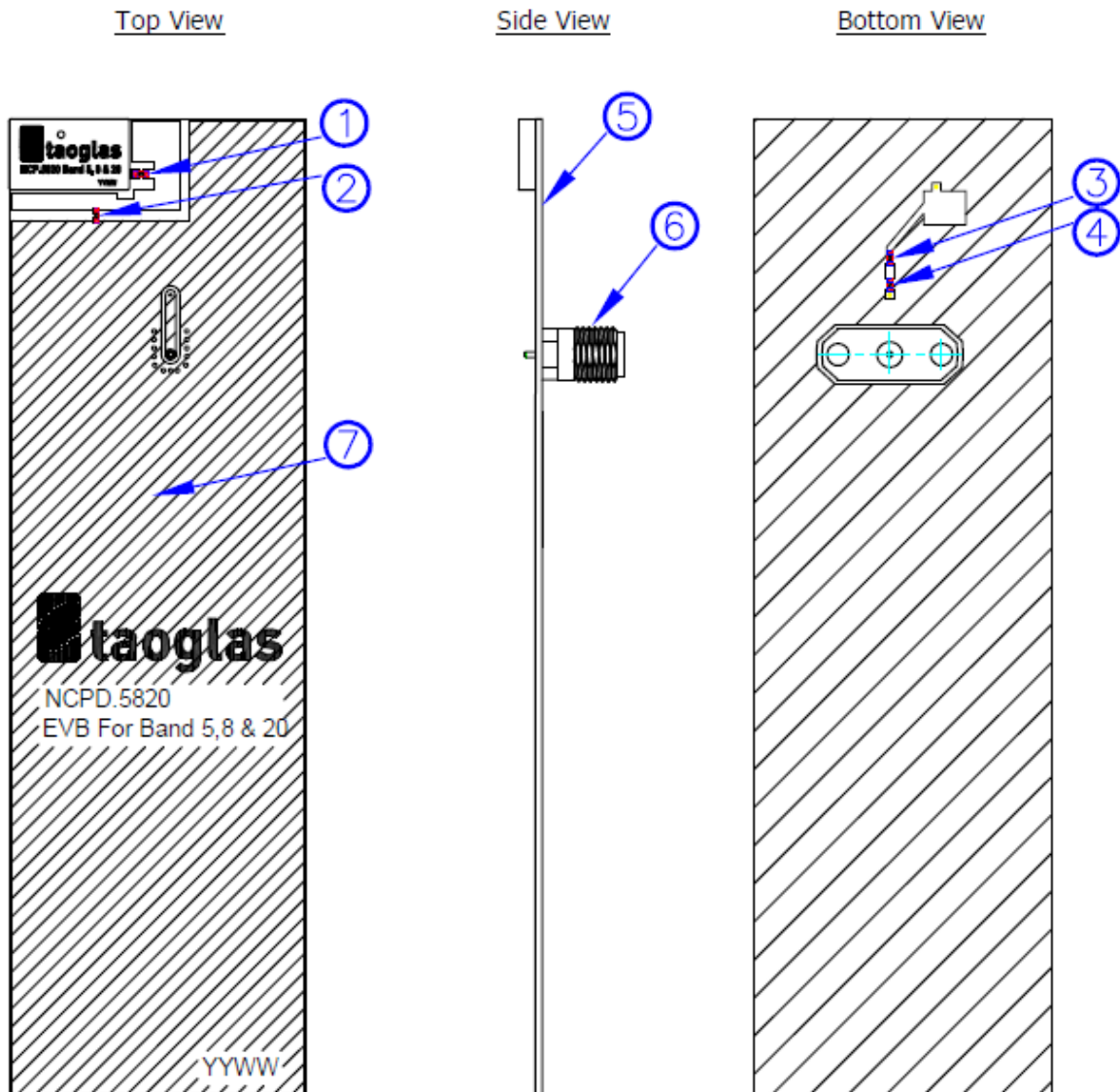

| | Name | Material | Finish | QTY |
|---|---------------------|----------|--------|-----|
| 1 | Inductor L1(0402) | Ceramic | N/A | 1 |
| 2 | Inductor L2(0402) | Ceramic | N/A | 1 |
| 3 | Capactance C1(0402) | Ceramic | N/A | 1 |
| 4 | Inductor L3(0402) | Ceramic | N/A | 1 |
| 5 | NCPD.5820 EVB PCB | FR4 0.8t | Gold | 1 |
| 6 | SMA(F) ST PCB | Brass | Gold | 1 |
| 7 | NCP.5820 Antenna | Ceramic | White | 1 |

7.3 Evaluation Board Matching Circuit

Band5,8

| | Name | P/N | Material | Finish | QTY |
|---|-----------------------------|--------------------|----------|--------|-----|
| 1 | Inductor L1=0R (0402) | Any | Ceramic | N/A | 1 |
| 2 | Inductor L2=5.6nH (0402) | MHQ1005P5N6S | Ceramic | N/A | 1 |
| 3 | Capacitance C1=0.5pF (0402) | GRM1555C1HR50CA01D | Ceramic | N/A | 1 |
| 4 | Inductor L3=39nH (0402) | LQG15HS33NJ02D | Ceramic | N/A | 1 |

Band5,8,20

| | Name | P/N | Material | Finish | QTY |
|---|-----------------------------|--------------------|----------|--------|-----|
| 1 | Inductor L1=1.5nH (0402) | LQG15HS1N5S02D | Ceramic | N/A | 1 |
| 2 | Inductor L2=6.8nH (0402) | MHQ1005P6N8J | Ceramic | N/A | 1 |
| 3 | Capacitance C1=0.5pF (0402) | GRM1555C1HR50CA01D | Ceramic | N/A | 1 |
| 4 | Inductor L3=39nH (0402) | LQG15HS33NJ02D | Ceramic | N/A | 1 |

8. Packaging

700pcs NCP.5820 per Tape & Reel
Dimensions - 350*340*47mm
Weight - 1.1Kg

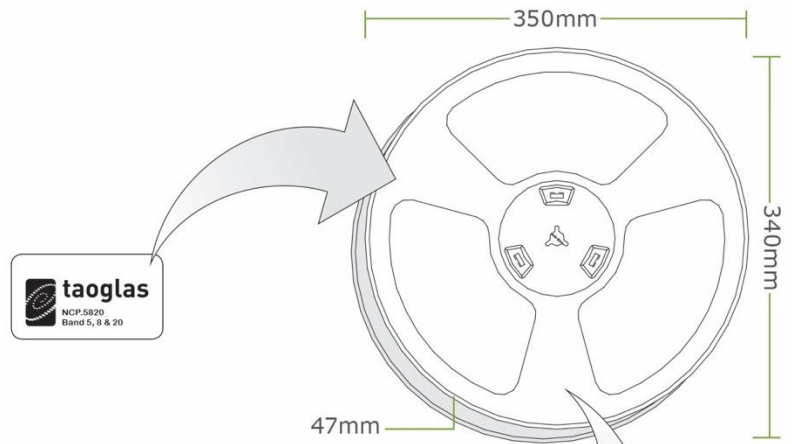

3500pcs NCP.5820 per carton
Dimensions - 360*370*275mm
Weight - 5.9Kg

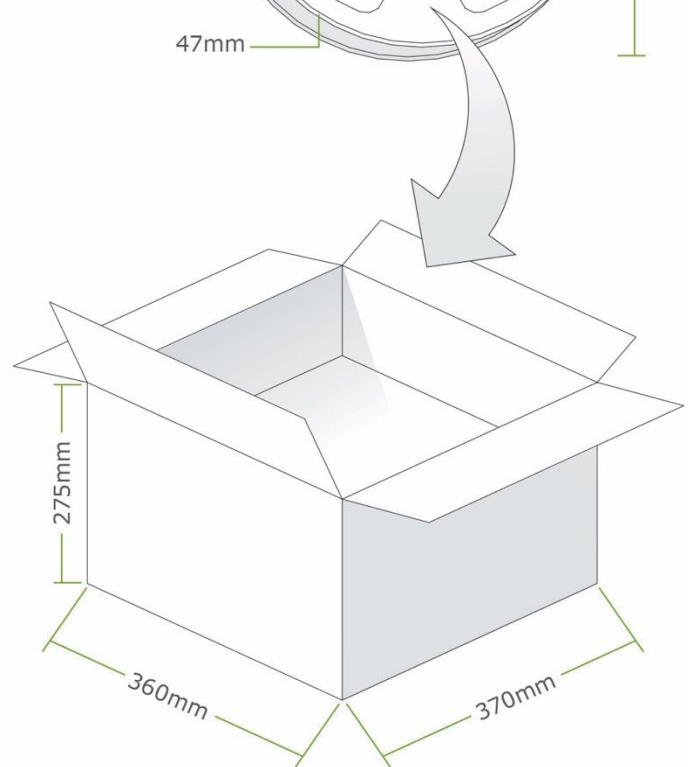

Taoglas makes no warranties based on the accuracy or completeness of the contents of this document and reserves the right to make changes to specifications and product descriptions at any time without notice. Taoglas reserves all rights to this document and the information contained herein.

Reproduction, use or disclosure to third parties without express permission is strictly prohibited.

Copyright © Taoglas Ltd.