

SRBH-06H1A1

Non-Isolated DC-DC Converter

The SRBH-06H1A1 is part of the low cost non-isolated dc/dc power converter series providing up to 6A output current.

The output is closely regulated and the efficiency of 3.3Vdc output is typically 89% at full load.

Typical features include remote on/off, input under voltage lockout, over current protection and short circuit protection.



Key Features & Benefits

- 8-36 VDC Input / 3.3-5 VDC @ 6 A Output
- Non-isolated output
- High Efficiency
- High Power Density
- Excellent Thermal Performance
- OCP/SCP
- Remote On/Off
- Input Under Voltage Lockout
- Low Cost
- Class 2, Category 2, Non-Isolated DC/DC Converter (refer to IPC-9592B)

Applications

- Distributed Power Architectures
- Data Networking Equipment
- Telecommunications Applications



bel POWER
SOLUTIONS &
PROTECTION

a bel group

belfuse.com/power-solutions

1. MODEL SELECTION

MODEL NUMBER	OUTPUT VOLTAGE	INPUT VOLTAGE	MAX. OUTPUT CURRENT	MAX. OUTPUT POWER	TYPICAL EFFICIENCY
SRBH-06H1A1	3.3V -5V	8 V- 36 V	6 A	30 W	89%(Vo=3.3, Io=6A)

NOTE: Add "R" indicating Tape and Reel packaging.

PART NUMBER EXPLANATION

S	R	BH	-	06	H	1A	1	R
Mounting Type	RoHS Status	Series Name		Output Current	Input Range	Output Voltage	Active Logic	Package Type
SMD	RoHS	Arrow Head		6A	8V – 36V	3.3V -5.0V	Active High	R – Tape & Reel

2. ABSOLUTE MAXIMUM RATINGS

PARAMETER	DESCRIPTION	MIN	TYP	MAX	UNITS
Continuous Non-operating Input Voltage		-0.3	-	38	V
Remote On/Off		-0.3	-	12	V
Ambient Temperature		-40	-	85	°C
Storage Temperature		-40	-	125	°C
Altitude		-	-	2000	m

NOTE: Ratings used beyond the maximum ratings may cause a reliability degradation of the converter or may permanently damage the device.

3. INPUT SPECIFICATIONS

All specifications are typical at 25°C unless otherwise stated.

PARAMETER	DESCRIPTION	MIN	TYP	MAX	UNITS
Operating Input Voltage		8	-	36	V
Input Current (full load)	Vin=12V, Vo=3.3V, Io=6A	-	1.9	-	A
Input Current (no load)		-	30	-	mA
Remote Off Input Current		-	1.7	-	mA
Input Reflected Ripple Current (rms)	1uH, 2*100 uF/50 V electrolytic capacitors, 3*4.7 uF/50V ceramic capacitor at the input.	-	50	100	mA
Input Reflected Ripple Current (pk-pk)		-	70	150	mA
I2t Inrush Current Transient		-	-	1	A2s
Turn on Voltage Threshold	Input under voltage lockout (UVLO).	-	7	7.5	V
Turn off Voltage Threshold		3.5	4	-	V

CAUTION: All specifications are typical at nominal input, full load at 25°C unless noted.

4. OUTPUT SPECIFICATIONS

All specifications are typical at nominal input, full load at 25°C unless otherwise stated.

PARAMETER	DESCRIPTION	MIN	TYP	MAX	UNITS
Output Voltage Set Point	V _{in} =12 V, I _o =50% full load	3.234	3.300	3.366	V
Load Regulation		-	±10	±20	mV
Line Regulation		-	±10	±20	mV
Regulation Over Temperature	-40 °C to +85 °C	-	30	50	mV
Ripple and Noise (pk-pk)	V _{out} =3.3V	-	60	100	mV
Ripple and Noise (rms)		-	25	50	mV
Output Current Range		0	-	6	A
Output DC Current Limit	Hiccup mode	7	10	13	A
Turn on Time(from V _{in})		-	6	10	ms
Turn on Time(from Enable)		-	1	-	ms
Output capacitance		220	-	1200	uF
Transient Response					
ΔV 50%~100% of Max Load		-	100	200	mV
Settling Time	di/dt = 0.5 A/us; V _{in} = 12 V; V _{out} =3.3V; with a 220 uF Oscan capacitor at the output	-	300	500	us
ΔV 100%~50% of Max Load		-	100	200	mV
Settling Time		-	300	500	us

5. GENERAL SPECIFICATION

PARAMETER	DESCRIPTION	MIN	TYP	MAX	UNITS
Efficiency	V _{in} =12V V _o =3.3V full load	87	89	-	%
Switching Frequency		-	300	-	KHz
Output Trim Range		3.3	-	5	V
Weight		-	4.3	-	g
MTBF		-	426,574,0	-	hours
Dimensions					
Inches (L × W × H)			0.885 × 0.512 × 0.320		Inches
Millimeters (L × W × H)			22.48 × 13.00 × 8.13		mm

6. CONTROL/SUPERVISORY SPECIFICATIONS

PARAMETER	DESCRIPTION	MIN	TYP	MAX	UNITS
Enable					
Signal Low (Unit Off)	ENABLE pin open, unit on	-0.3	-	1	V
Signal High(Unit On)		2.8	-	12	V
Sourcing current		-	-	10	uA

7. EFFICIENCY DATA

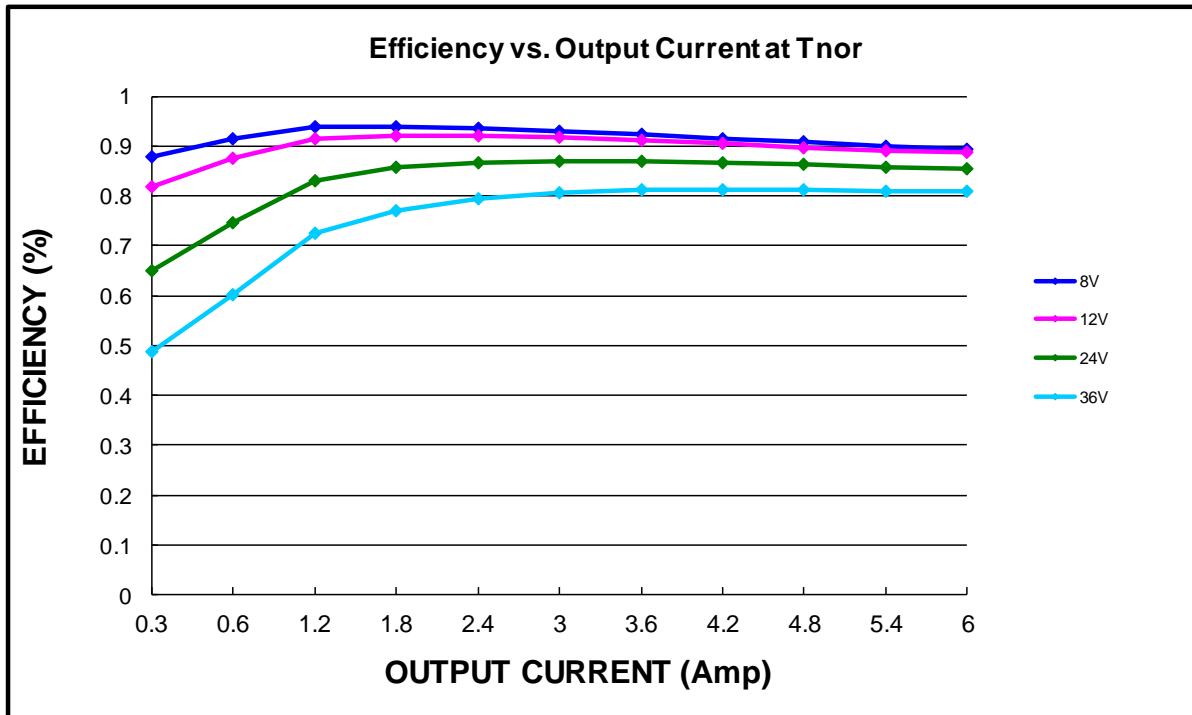

8. THERMAL DERATING CURVE

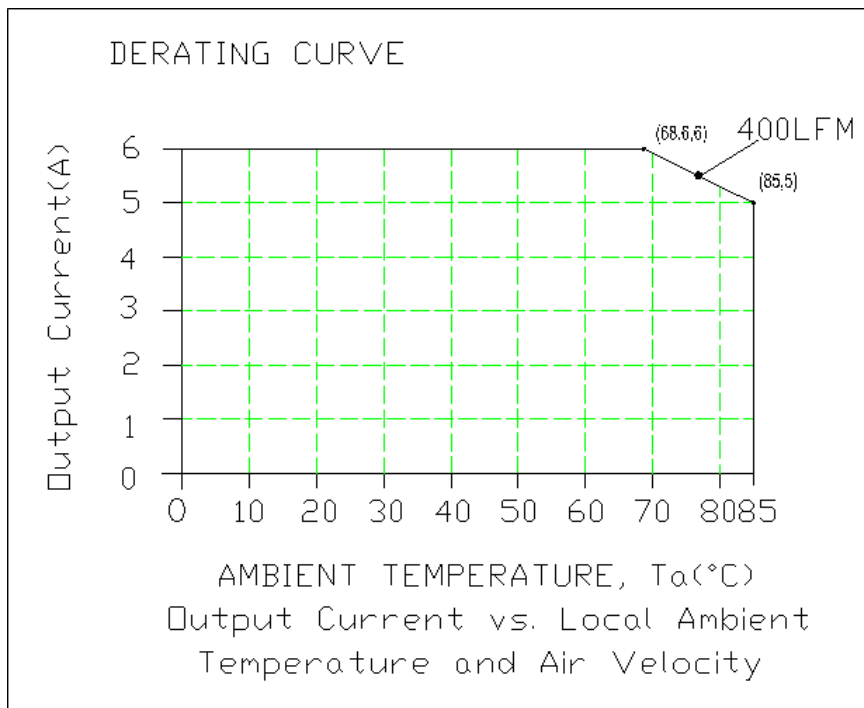

$V_{in}=12V, V_o=3.3V$

9. RIPPLE AND NOISE WAVEFORM

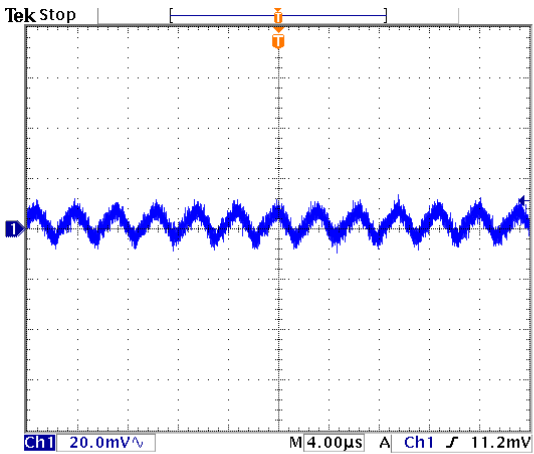

Ripple and noise at no load, $V_{in}=12V$

15 Mar 2017 10:34:00

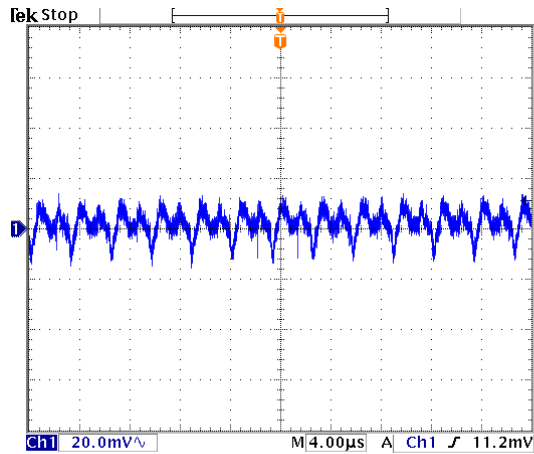

Ripple and noise at full load, $V_{in}=12V$

15 Mar 2017 10:33:53

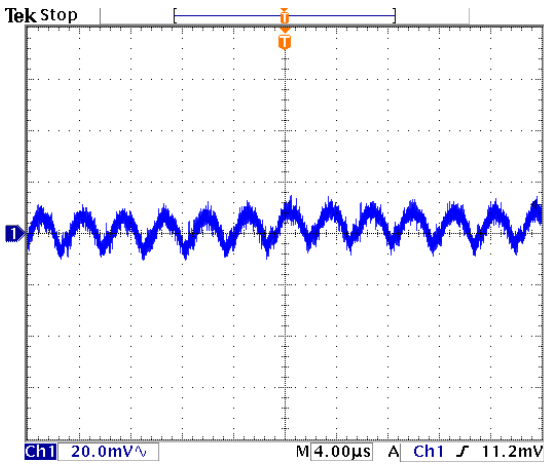

Ripple and noise at no load, $V_{in}=24V$

15 Mar 2017 10:33:23

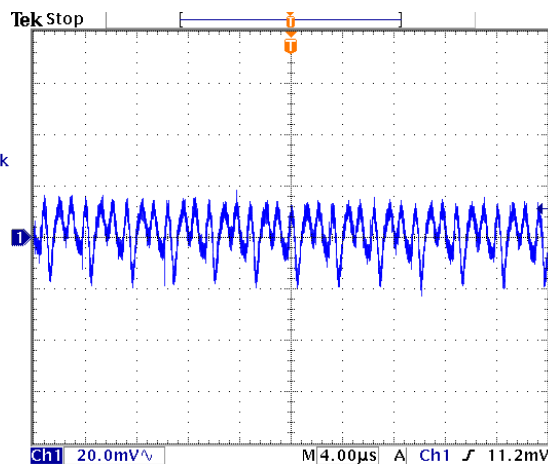

Ripple and noise at full load, $V_{in}=24V$

15 Mar 2017 10:33:40

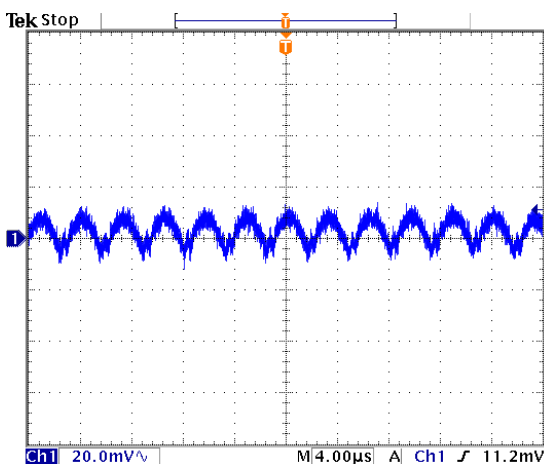

Ripple and noise at no load, $V_{in}=36V$

15 Mar 2017 10:33:09

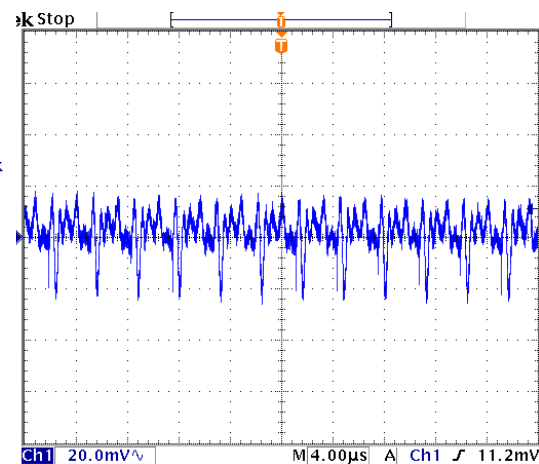

Ripple and noise at full load, $V_{in}=36V$

15 Mar 2017 10:32:41

Note: Ripple and Noise at 3.3 Vdc output, with a 220 μF oscan capacitor cap at the output, $T_a=25$ deg C.

10. Startup & Shutdown

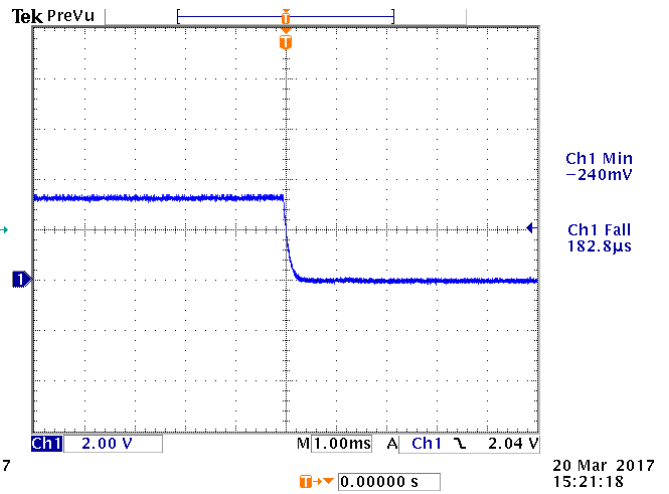
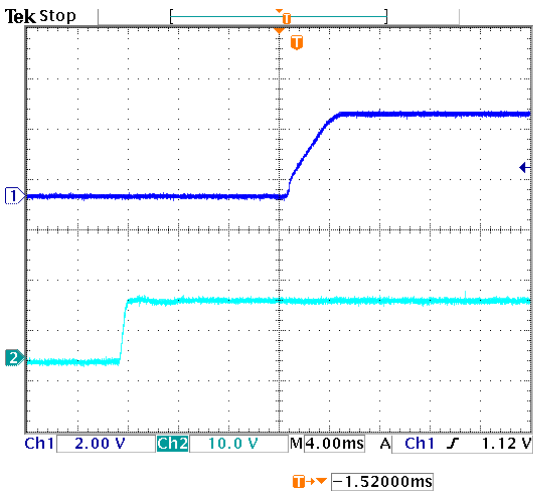

Note: Test Condition: Vin=12V, Iout=6A, with a 220µF oscon capacitor at the output.

11. Transient Response Waveforms

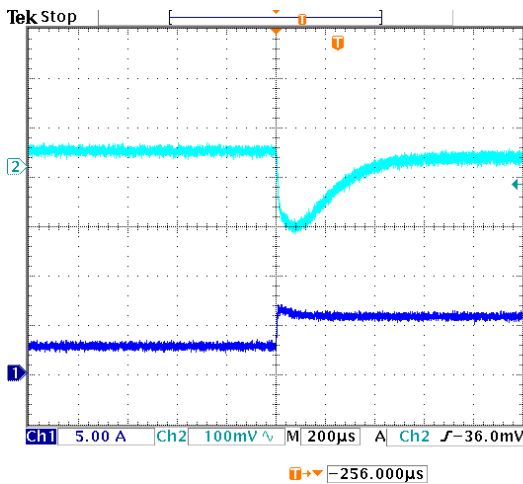

*50% to 100% load transient at 12Vdc input
5Vdc output and Ta=25 deg C*

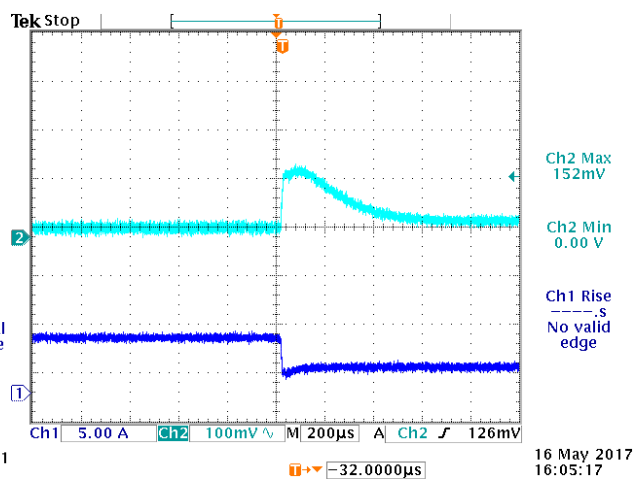

*100% to 50% load transient at 12Vdc input,
5Vdc output and Ta=25 deg C*

Note: Test Condition: di/dt=0.5A/µs, Vin=12V, with a 220µF oscon capacitor at the output.

12. INPUT UNDER-VOLTAGE LOCKOUT

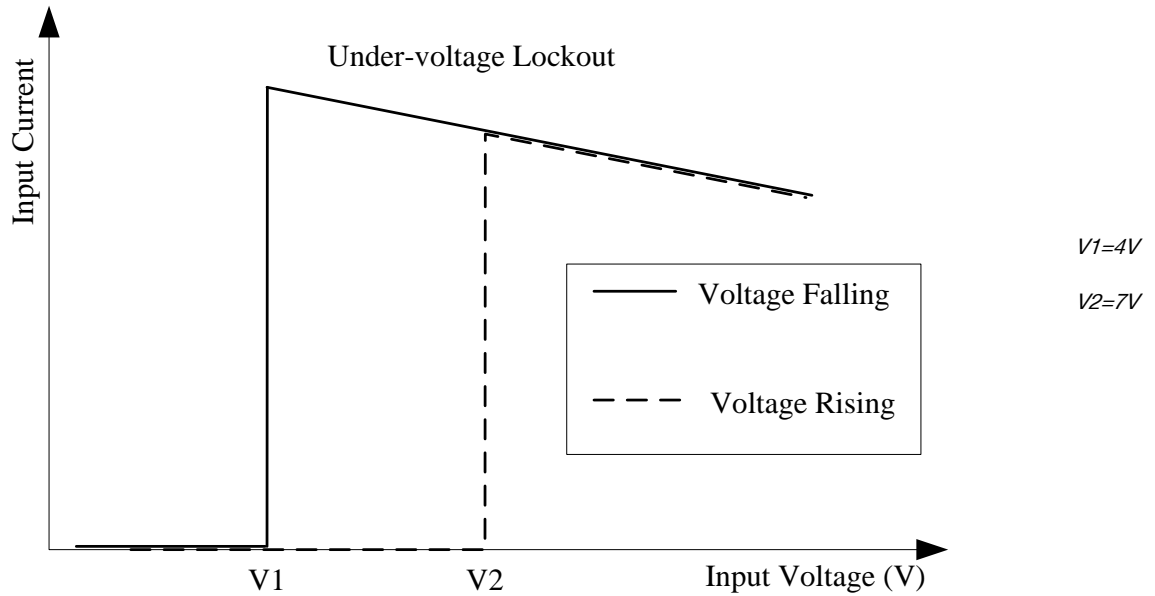

13. OUTPUT VOLTAGE TRIM

Equations for calculating the trim resistor (in k Ω) given the desired adjusted voltage (V_{adj}) and the nominal output voltage of the converter ($V_{nom}=3.3V$) are shown below. The Trim Down resistor should be connected between the Trim pin and V_{out} . The Trim Up resistor should be connected between the Trim pin and Ground. Only one of the resistors should be used for any given application.

$$R_{trimdown} = \frac{151.6}{V_{nom} - V_{adj}} - 70.2$$

$$R_{trimup} = \frac{33.7}{V_{adj} - V_{nom}} - 14$$

14. SOLDERING INFORMATION

The SRBH-06H1A1 modules are designed to be compatible with reflow soldering process. The suggested Pb-free solder paste is Sn/Ag/Cu(SAC). The recommended reflow profile using Sn/Ag/Cu solder is shown in the following. Recommended reflow peak temperature is 245°C while the part can withstand peak temperature of 260°C maximum for 10seconds. This profile should be used only as a guideline. Many other factors influence the success of SMT reflow soldering. Since your production environment may differ, please thoroughly review these guidelines with your process engineers.

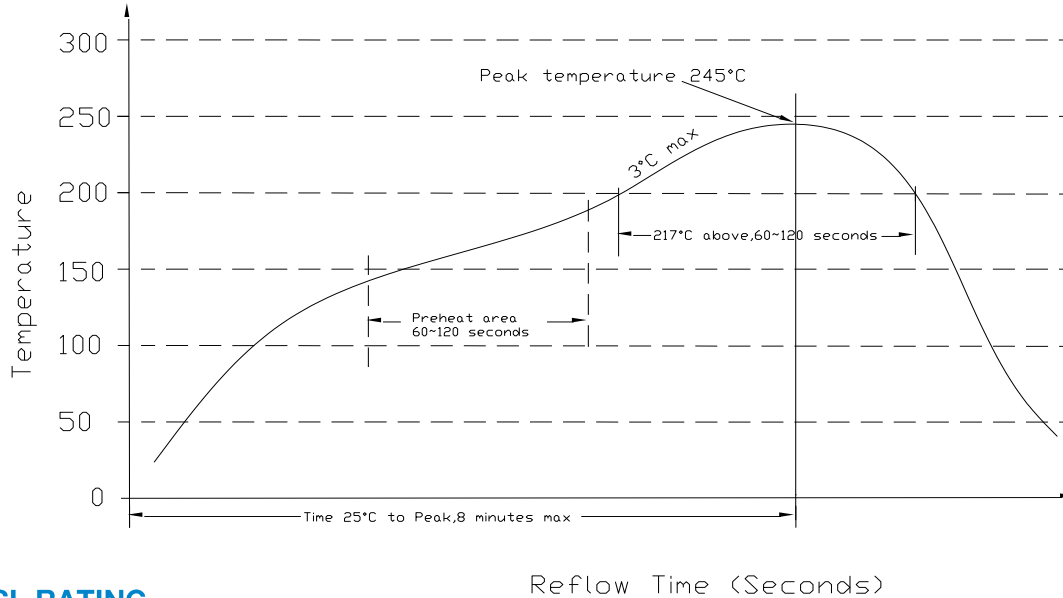

15. MSL RATING

The SRBH-06H1A1 modules have a MSL rating of 3.

16. STORAGE AND HANDLING

The SRBH-06H1A1 modules are designed to be compatible with J-STD-033 Rev:A (Handling, Packing, Shipping and Use of Moisture /Reflow Sensitive surface Mount devices). Moisture barrier bags (MBB) with desiccant are applied. The recommended storage environment and handling procedure is detailed in J-STD-033.

17. PRE-BAKING

This component has been designed, handled, and packaged ready for Pb-free reflow soldering. If the assembly shop follows J-STD-033 guidelines, no pre-bake of this component is required before being reflowed to a PCB. Our packaging tray can only withstand temperature of 70°C max.

18. MECHANICAL DIMENSIONS

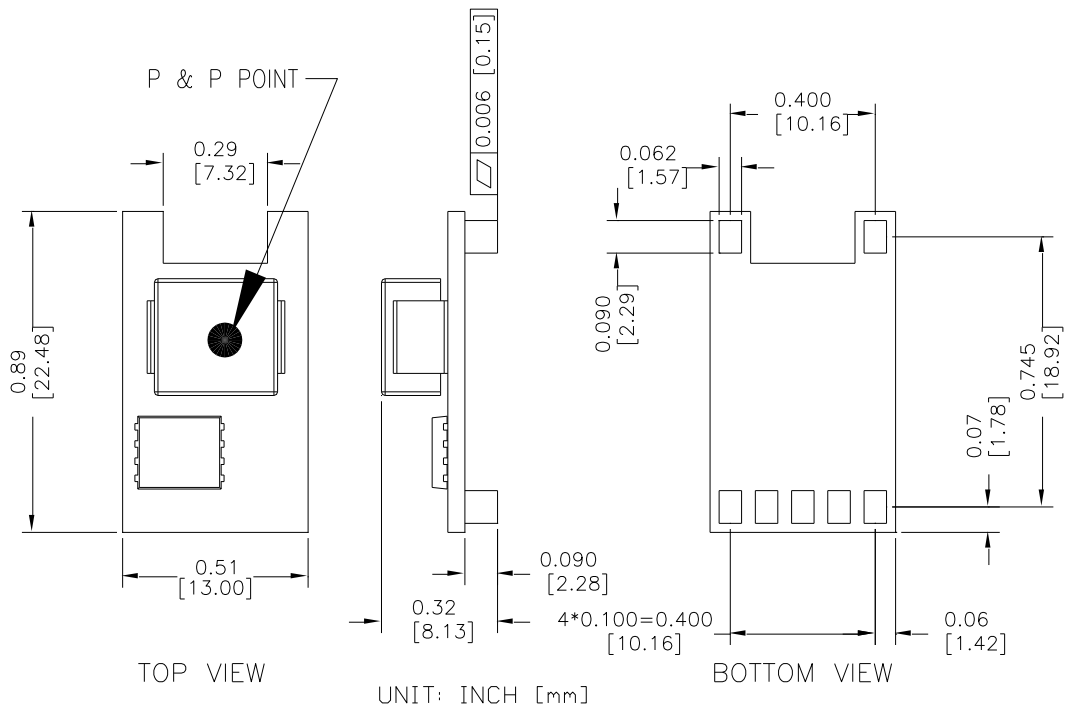

RECOMMENDED PCB PAD LAYOUT

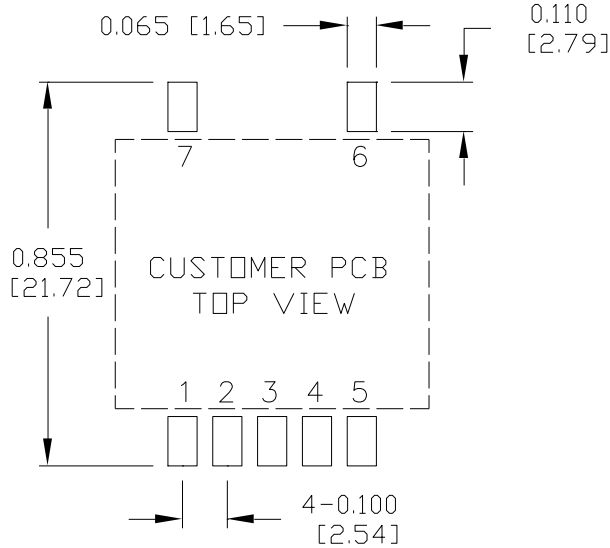

PIN CONNECTIONS

Pin	Function
1	Remote On/Off
2	Vin
3	GND
4	Vout
5	Trim
6	N/A
7	N/A

NOTES:

- 1) All Pins: Material - Copper Alloy;
Finish - Tin plated
- 2) Undimensioned components are shown for visual reference only.
- 3) All dimensions in inches; Tolerances: x.xx +/-0.02 in [0.51 mm]. x.xxx +/-0.010 in [0.25 mm].

19. PACKAGING INFORMATION

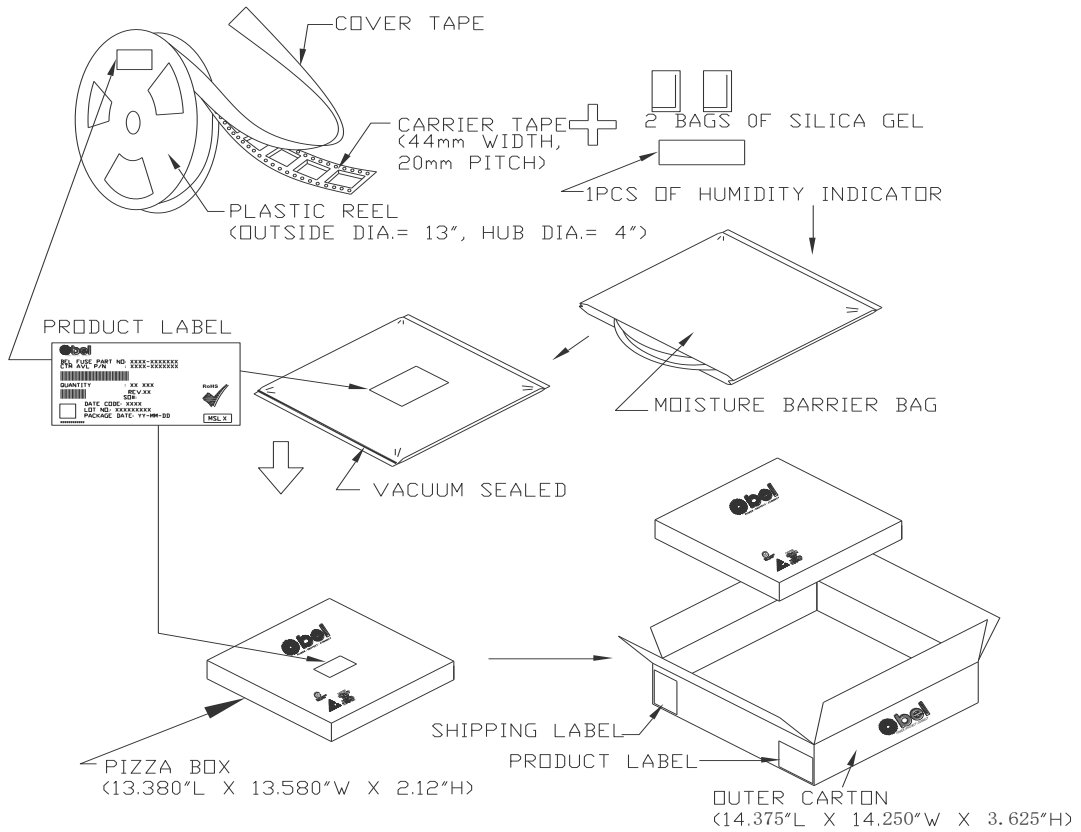

➔ USER FEED DIRECTION

ORIENTATION OF COMPONENT INSIDE POCKET

TAPE WIDTH	44mm
POCKET PITCH	20mm
QUANTITY OF COMPONENTS PER REEL	320
PLASTIC REEL OUTER DIAMETER	13 INCHES
PLASTIC REEL HUB DIAMETER	4 INCHES
COMPLY WITH EIA 481-2-A	

20. REVISION HISTORY

DATE	REVISION	CHANGES DETAIL	APPROVAL
2017-3-23	AA	First release	S Wang
2017-05-16	AB	Change MTBF UVLO, Add packaging information	S Wang
2017-08-29	AC	Update Line and load Regulation, Output Current Limit, Transient response, Input Reflected Ripple Current.	S Wang
2018-04-26	AD	Update PRE-BAKING	S Wang

For more information on these products consult: tech.support@psbel.com

NUCLEAR AND MEDICAL APPLICATIONS - Products are not designed or intended for use as critical components in life support systems, equipment used in hazardous environments, or nuclear control systems.

TECHNICAL REVISIONS - The appearance of products, including safety agency certifications pictured on labels, may change depending on the date manufactured. Specifications are subject to change without notice.



Asia-Pacific
+86 755 298 85888

Europe, Middle East
+353 61 225 977

North America
+1 408 785 5200