

Sensitive high immunity 0.25 A SCR Thyristor

Datasheet - production data

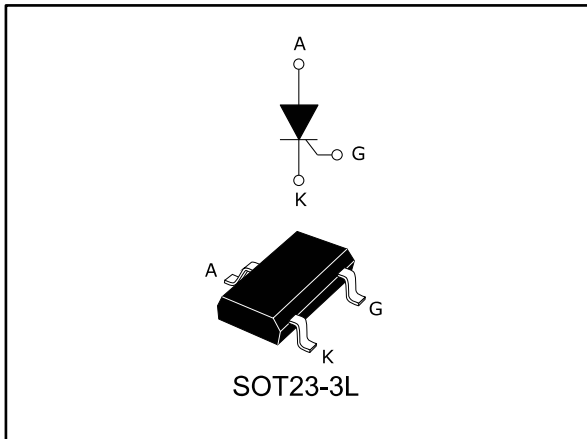

Description

Thanks to highly sensitive triggering levels, the 0.25 A P0102AL SCR thyristor is suitable for all applications where available gate current is limited. Its high immunity makes it ideal for high electric noise circuits.

The surface mount SOT23-3L package allows compact, SMD based designs for automated manufacturing.

Table 1: Device summary

Symbol	Value	Unit
$I_{T(RMS)}$	0.25	A
V_{DRM}/V_{RRM}	100	V
I_{GT}	200	μA
$T_j \text{ max.}$	125	$^{\circ}C$

Features

- $I_{T(RMS)}$ 0.25 A
- Low 200 μA gate current
- High noise immunity 200 V/ μs
- ECOPACK[®]2 compliant component

Applications

- Standby mode power supplies
- Smoke detectors
- DC 24/48 V proximity sensors
- Gate driver for large thyristors
- Overvoltage crowbar protection
- Capacitive ignition circuit

1 Characteristics

Table 2: Absolute maximum ratings (limiting values), T_j = 25 °C unless otherwise specified

Symbol	Parameter		Value	Unit	
I _{T(RMS)}	RMS on-state current (180 ° conduction angle)		T _{amb} = 36 °C	A	
I _{T(AV)}	Average on-state current (180 ° conduction angle)				0.25
I _{TSM}	Non repetitive surge peak on-state current (T _j initial = 25 °C)		t _p = 8.3 ms	7	A
			t _p = 10 ms	6	
I ² t	I ² t value for fusing		t _p = 10 ms	0.18	A ² s
di/dt	Critical rate of rise of on-state current I _G = 2 x I _{GT} , t _r ≤ 100 ns	f = 60 Hz	T _j = 125 °C	50	A/μs
V _{DRM} /V _{RRM}	Repetitive peak off-state voltage		T _j = 125 °C	100	V
I _{GM}	Peak gate current	t _p = 20 μs	T _j = 125 °C	0.5	A
P _{G(AV)}	Average gate power dissipation		T _j = 125 °C	0.02	W
T _{stg}	Storage junction temperature range			-40 to +150	°C
T _j	Operating junction temperature			-40 to +125	°C

Table 3: Electrical characteristics (T_j = 25 °C unless otherwise specified)

Symbol	Test Conditions		Value	Unit	
I _{GT}	V _D = 12 V, R _L = 140 Ω		Max.	200	μA
V _{GT}			Max.	0.8	V
V _{GD}	V _D = V _{DRM} , R _L = 3.3 kΩ, R _{GK} = 1000 Ω	T _j = 125 °C	Min.	0.1	V
V _{RG}	I _{RG} = 10 μA		Min.	8	V
I _H	I _T = 50 mA, R _{GK} = 1000 Ω		Max.	6	mA
I _L	I _G = 1.2 x I _{GT} , R _{GK} = 1000 Ω		Max.	7	mA
dV/dt	V _D = 67 % V _{DRM} , R _{GK} = 1000 Ω	T _j = 125 °C	Min.	200	V/μs

Table 4: Static characteristics

Symbol	Test conditions		Value	Unit		
V _{TM}	I _{TM} = 0.4 A, t _p = 380 μs	T _j = 25 °C	Max.	1.7	V	
V _{TO}	Threshold voltage		Max.	1		
R _D	Dynamic resistance		T _j = 125 °C	Max.	1000	mΩ
I _{DRM} /I _{RRM}	V _D = V _{DRM} ; V _R = V _{RRM} , R _{GK} = 1000 Ω		T _j = 25 °C	Max.	1	μA
			T _j = 125 °C		100	

Table 5: Thermal parameters

Symbol	Parameter	Value	Unit
R _{th(j-a)}	Junction to ambient (Mounted on FR4 with recommended pad layout)	400	°C/W

1.1 Characteristics (curves)

Figure 1: Maximum average power dissipation versus average on-state current

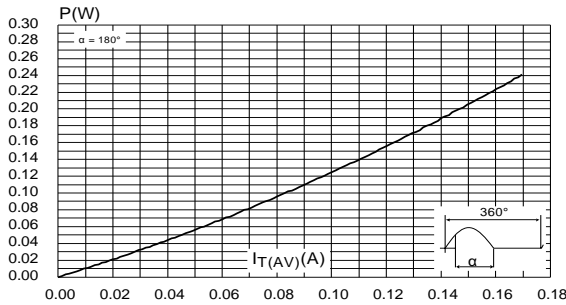

Figure 2: Average and DC on-state current versus ambient temperature

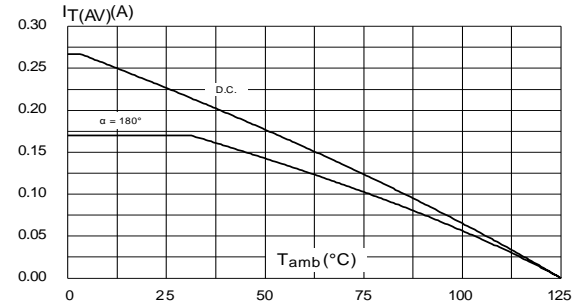

Figure 3: Relative variation of thermal impedance junction to ambient versus pulse duration

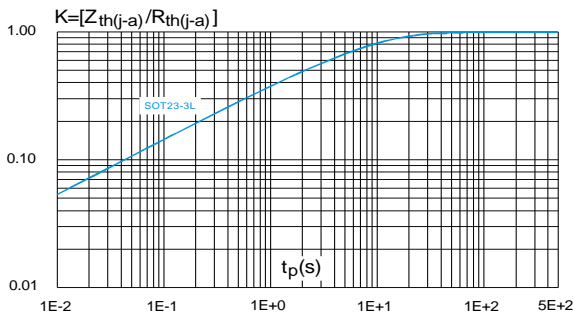

Figure 4: Gate trigger, holding, and latching currents with gate trigger voltage versus junction temperature

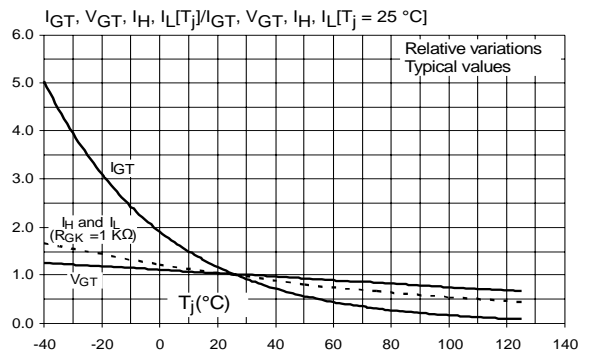

Figure 5: Relative variation of holding current versus gate-cathode resistance

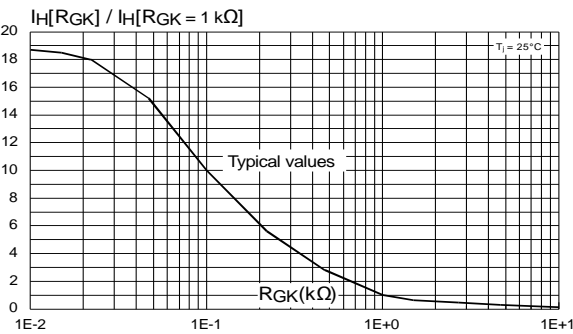

Figure 6: Relative variation of dV/dt immunity versus gate-cathode resistance

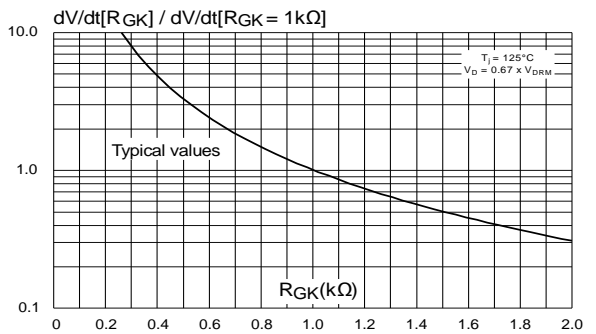

Figure 7: Relative variation of dV/dt immunity versus gate-cathode capacitance

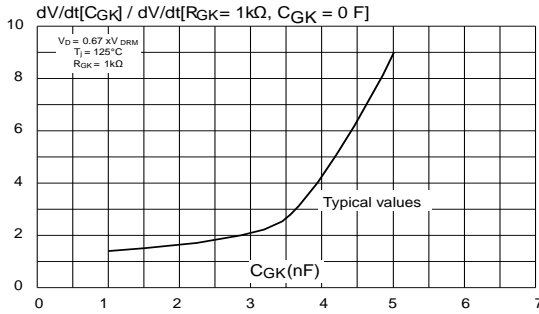

Figure 8: Surge peak on-state current versus number of cycles

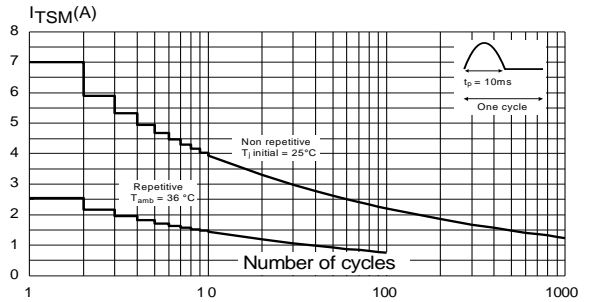

Figure 9: Non-repetitive surge peak on-state current for sinusoidal pulse (tp < 10 ms)

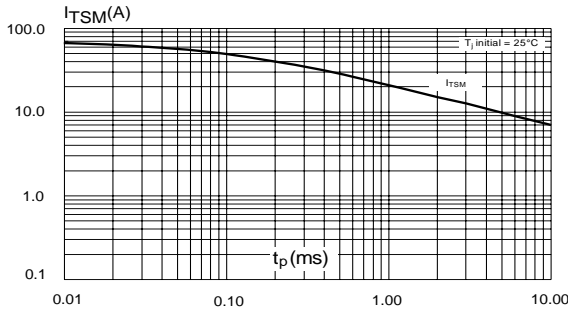

Figure 10: On-state characteristics

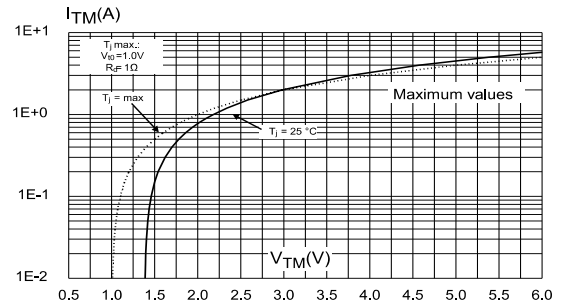
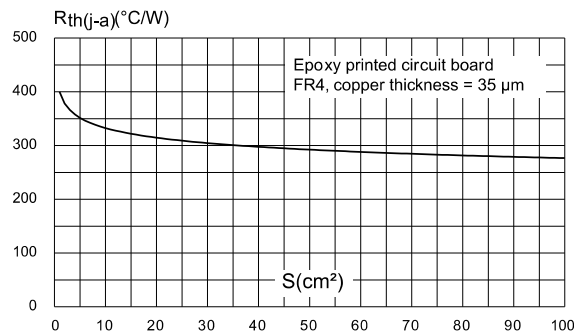

Figure 11: Thermal resistance junction to ambient versus copper surface under tab



2 Package information

In order to meet environmental requirements, ST offers these devices in different grades of ECOPACK® packages, depending on their level of environmental compliance. ECOPACK® specifications, grade definitions and product status are available at: www.st.com. ECOPACK® is an ST trademark.

- Lead-free package
- Halogen free molding resin
- Epoxy meets UL94, V0

2.1 SOT23-3L package information

Figure 12: SOT23-3L package outline

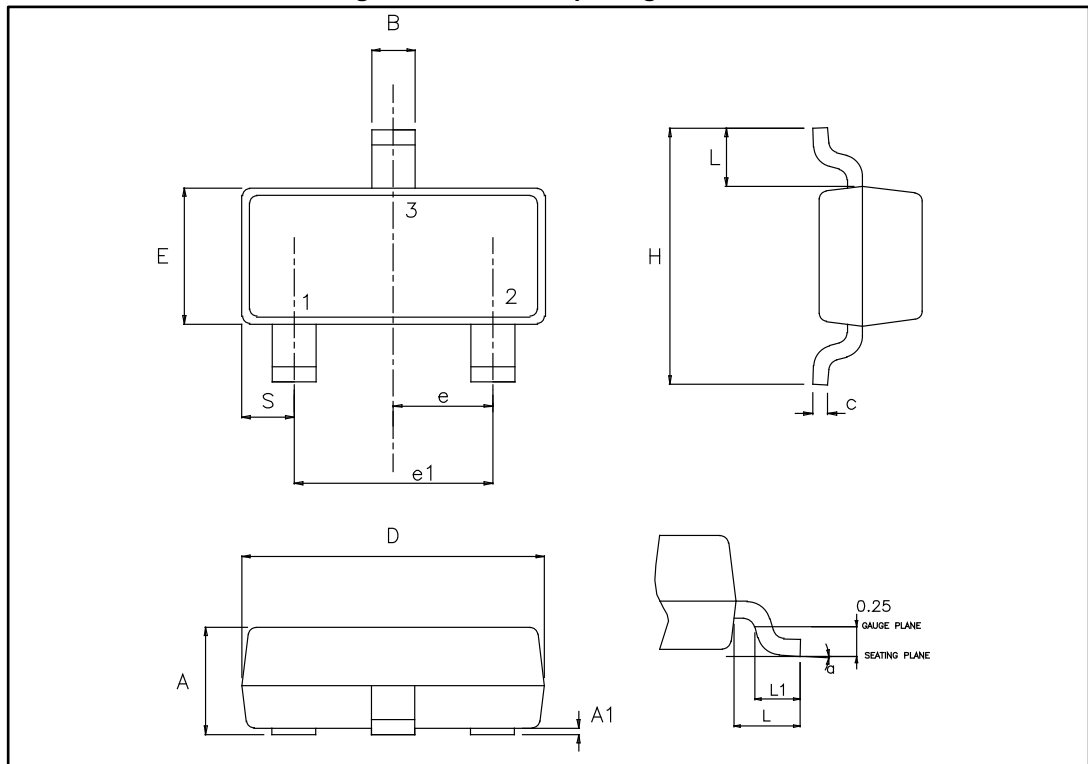

This package drawing may slightly differ from the physical package. However, all the specified dimensions in the following table are guaranteed.

Table 6: SOT23-3L package mechanical data

Ref.	Dimensions					
	Millimeters			Inches ⁽¹⁾		
	Min.	Typ.	Max.	Min.	Typ.	Max.
A	0.89		1.40	0.0350		0.0551
A1	0.00		0.10	0.0000		0.0039
B	0.30		0.51	0.0118		0.0201
C	0.085		0.18	0.0033		0.0071
D	2.75		3.04	0.1083		0.1197
e	0.85		1.05	0.0335		0.0413
e1	1.70		2.10	0.0669		0.0827
E	1.20		1.75	0.0472		0.0689
H	2.10		3.00	0.0827		0.1181
L		0.60			0.0236	
S	0.35		0.65	0.0138		0.256
L1	0.25		0.55	0.0098		0.0217
a	0°		8°	0°		8°

Notes:

⁽¹⁾Dimension in inches are given for reference only.

Figure 13: SOT23-3L footprint in mm

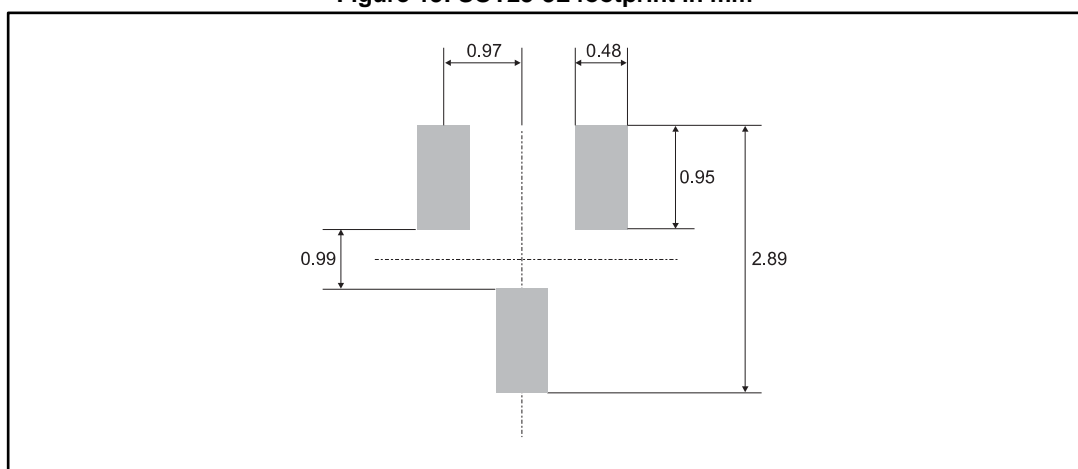

This drawing may not be in scale; however, all the specified dimensions are guaranteed.

3 Ordering information

Figure 14: Ordering information scheme

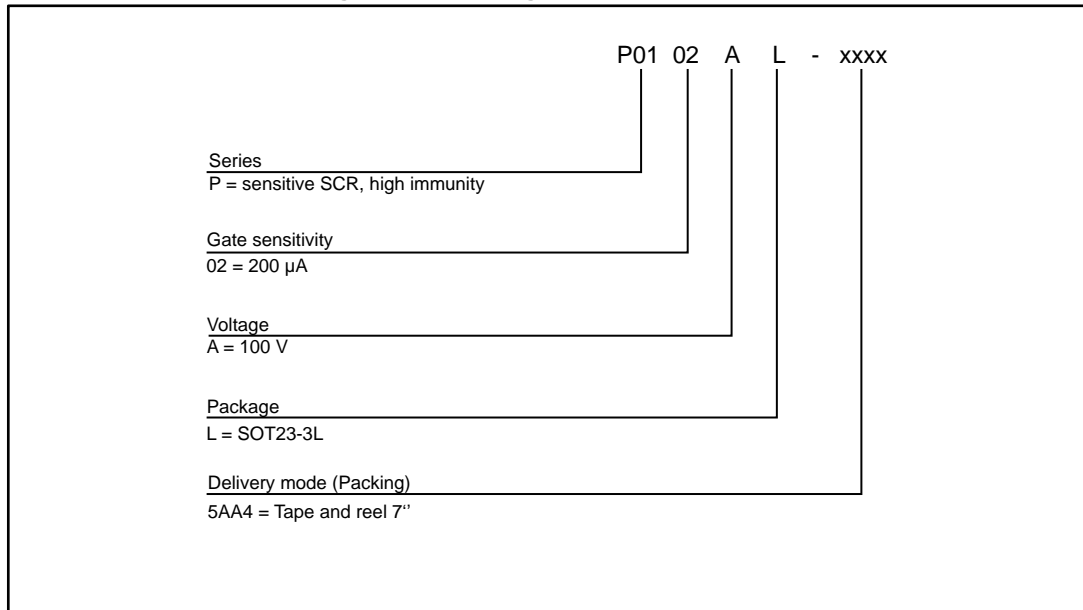

Table 7: Ordering information

Order code	Marking	Package	Weight	Base qty.	Delivery mode
P0102AL 5AA4	P2A	SOT23-3L	0.01 g	3000	Tape and reel 7"

4 Revision history

Table 8: Document revision history

Date	Revision	Changes
18-Oct-2016	1	Initial release.
13-Jun-2017	2	Updated <i>Table 4: "Static characteristics"</i> .
09-Aug-2017	3	Updated drawing in cover page.

IMPORTANT NOTICE – PLEASE READ CAREFULLY

STMicroelectronics NV and its subsidiaries ("ST") reserve the right to make changes, corrections, enhancements, modifications, and improvements to ST products and/or to this document at any time without notice. Purchasers should obtain the latest relevant information on ST products before placing orders. ST products are sold pursuant to ST's terms and conditions of sale in place at the time of order acknowledgement.

Purchasers are solely responsible for the choice, selection, and use of ST products and ST assumes no liability for application assistance or the design of Purchasers' products.

No license, express or implied, to any intellectual property right is granted by ST herein.

Resale of ST products with provisions different from the information set forth herein shall void any warranty granted by ST for such product.

ST and the ST logo are trademarks of ST. All other product or service names are the property of their respective owners.

Information in this document supersedes and replaces information previously supplied in any prior versions of this document.

© 2017 STMicroelectronics – All rights reserved