



Circuit breaker size S00 for motor protection, CLASS 10 A-release 4.5...6.3 A N-release 82 A screw terminal Standard switching capacity

<b>product brand name</b>	SIRIUS
<b>product designation</b>	Circuit breaker
<b>design of the product</b>	For motor protection
<b>product type designation</b>	3RV2
<b>General technical data</b>	
<b>Product equipment of circuit breaker for motor protection complete unit with protection device</b>	Yes
<b>size of the circuit-breaker</b>	S00
<b>size of contactor can be combined company-specific</b>	S00, S0
product function disconnecter functionality	Yes
product extension auxiliary switch	Yes
<b>power loss [W] for rated value of the current</b>	
• at AC in hot operating state	7.25 W
• at AC in hot operating state per pole	2.4 W
<b>type of calculation of power loss current-dependent</b>	quadratic
insulation voltage with degree of pollution 3 at AC rated value	690 V
<b>surge voltage resistance rated value</b>	6 kV
<b>maximum permissible voltage for protective separation</b>	
• in networks with ungrounded star point between main and auxiliary circuit	400 V
• in networks with grounded star point between main and auxiliary circuit	400 V
<b>protection class IP</b>	
• on the front according to IEC 60529	IP20
• on the front	IP20
• of the terminal	IP20
<b>shock resistance according to IEC 60068-2-27</b>	25g / 11 ms
<b>mechanical service life (operating cycles)</b>	
• of the main contacts typical	100 000
• of auxiliary contacts typical	100 000
electrical endurance (operating cycles) typical	100 000
<b>reference code according to IEC 81346-2</b>	Q
<b>continuous current rated value</b>	6.3 A
<b>Substance Prohibitance (day/month/year)</b>	10/01/2009
<b>Net Weight</b>	353 g
<b>Ambient conditions</b>	
installation altitude at height above sea level maximum	2 000 m

<b>ambient temperature</b>	
• during operation	-20 ... +60 °C
• during storage	-50 ... +80 °C
• during transport	-50 ... +80 °C
<b>temperature compensation</b>	-20 ... +60 °C
relative humidity during operation	10 ... 95 %
<b>Main circuit</b>	
<b>number of poles for main current circuit</b>	3
<b>adjustable current response value current of the current-dependent overload release</b>	4.5 ... 6.3 A
<b>type of voltage for main current circuit</b>	AC
<b>operating voltage</b>	
• rated value	690 V
• rated value	20 ... 690 V
• at AC-3 rated value maximum	690 V
• at AC-3e rated value maximum	690 V
<b>operating frequency rated value</b>	50 ... 60 Hz
<b>operational current rated value</b>	6.3 A
<b>operational current</b>	
• at AC-3 at 400 V rated value	6.3 A
• at AC-3e at 400 V rated value	6.3 A
<b>operating power</b>	
• at AC-3	
— at 230 V rated value	1.5 kW
— at 400 V rated value	2.2 kW
— at 500 V rated value	3 kW
— at 690 V rated value	4 kW
• at AC-3e	
— at 230 V rated value	1.5 kW
— at 400 V rated value	2.2 kW
— at 500 V rated value	3 kW
— at 690 V rated value	4 kW
<b>operating frequency</b>	
• at AC-3 maximum	15 1/h
• at AC-3e maximum	15 1/h
<b>Auxiliary circuit</b>	
<b>type of voltage for auxiliary and control circuit</b>	AC/DC
<b>number of NC contacts for auxiliary contacts</b>	0
<b>number of NO contacts for auxiliary contacts</b>	0
number of CO contacts for auxiliary contacts	0
<b>Protective and monitoring functions</b>	
<b>product function</b>	
• ground fault detection	No
• phase failure detection	Yes
<b>trip class</b>	CLASS 10
<b>design of the overload release</b>	thermal
<b>protection function thermal overload protection (ANSI 49)</b>	Yes
<b>maximum short-circuit current breaking capacity (Icu)</b>	
• at AC at 240 V rated value	100 kA
• at AC at 400 V rated value	100 kA
• at AC at 500 V rated value	100 kA
• at AC at 690 V rated value	6 kA
<b>operating short-circuit current breaking capacity (Ics) at AC</b>	
• at 240 V rated value	100 kA
• at 400 V rated value	100 kA
• at 500 V rated value	100 kA
• at 690 V rated value	4 kA
response value current of instantaneous short-circuit trip unit	82 A
<b>UL/CSA ratings</b>	

<b>full-load current (FLA) for 3-phase AC motor</b>	
<ul style="list-style-type: none"> <li>● at 480 V rated value</li> <li>● at 600 V rated value</li> </ul>	<p>6.3 A</p> <p>6.3 A</p>
<b>yielded mechanical performance [hp]</b>	
<ul style="list-style-type: none"> <li>● for single-phase AC motor <ul style="list-style-type: none"> <li>— at 110/120 V rated value</li> <li>— at 230 V rated value</li> </ul> </li> <li>● for 3-phase AC motor <ul style="list-style-type: none"> <li>— at 200/208 V rated value</li> <li>— at 220/230 V rated value</li> <li>— at 460/480 V rated value</li> <li>— at 575/600 V rated value</li> </ul> </li> </ul>	<p>0.25 hp</p> <p>0.5 hp</p> <p>1 hp</p> <p>1.5 hp</p> <p>3 hp</p> <p>5 hp</p>
<b>UL File Number (CCN)</b>	E47705 (NLRV, NLRV7), E156943 (NKJH, NKJH7)
<b>Short-circuit protection</b>	
<b>product function short circuit protection</b>	Yes
<b>design of the short-circuit trip</b>	magnetic
<b>design of the fuse link for IT network for short-circuit protection of the main circuit</b>	
<ul style="list-style-type: none"> <li>● at 400 V</li> <li>● at 500 V</li> <li>● at 690 V</li> </ul>	<p>gL/gG 50 A</p> <p>gL/gG 40 A</p> <p>gL/gG 35 A</p>
certificate of suitability according to ATEX directive 2014/34/EU	DMT 02 ATEX F 001
<b>type of protection according to ATEX directive 2014/34/EU</b>	Ex II (2) GD
<b>Installation/ mounting/ dimensions</b>	
<b>mounting position</b>	any
<b>fastening method</b>	screw and snap-on mounting onto 35 mm DIN rail according to DIN EN 60715
<b>Mounting method of circuit breaker for Transformer protection, Generator protection and system protection optional standard bar mounting</b>	Yes
<b>height</b>	97 mm
<b>width</b>	45 mm
<b>depth</b>	97 mm
<b>required spacing</b>	
<ul style="list-style-type: none"> <li>● with side-by-side mounting <ul style="list-style-type: none"> <li>— forwards</li> <li>— backwards</li> <li>— upwards</li> <li>— downwards</li> <li>— at the side</li> </ul> </li> <li>● for grounded parts <ul style="list-style-type: none"> <li>— forwards</li> <li>— backwards</li> <li>— upwards</li> <li>— at the side</li> <li>— downwards</li> </ul> </li> <li>● for live parts <ul style="list-style-type: none"> <li>— forwards</li> <li>— backwards</li> <li>— upwards</li> <li>— downwards</li> <li>— at the side</li> </ul> </li> <li>● for grounded parts at 400 V <ul style="list-style-type: none"> <li>— downwards</li> <li>— upwards</li> <li>— at the side</li> </ul> </li> <li>● for live parts at 400 V <ul style="list-style-type: none"> <li>— downwards</li> <li>— upwards</li> <li>— at the side</li> </ul> </li> <li>● for grounded parts at 500 V</li> </ul>	<p>0 mm</p> <p>0 mm</p> <p>50 mm</p> <p>50 mm</p> <p>0 mm</p> <p>0 mm</p> <p>0 mm</p> <p>50 mm</p> <p>30 mm</p> <p>50 mm</p> <p>0 mm</p> <p>0 mm</p> <p>50 mm</p> <p>50 mm</p> <p>30 mm</p> <p>30 mm</p> <p>30 mm</p> <p>9 mm</p> <p>30 mm</p> <p>30 mm</p> <p>9 mm</p>

— downwards	30 mm
— upwards	30 mm
— at the side	9 mm
• for live parts at 500 V	
— downwards	30 mm
— upwards	30 mm
— at the side	9 mm
• for grounded parts at 690 V	
— downwards	50 mm
— upwards	50 mm
— backwards	0 mm
— at the side	30 mm
— forwards	0 mm
• for live parts at 690 V	
— downwards	50 mm
— upwards	50 mm
— backwards	0 mm
— at the side	30 mm
— forwards	0 mm

#### Connections/ Terminals

<b>product component removable terminal for auxiliary and control circuit</b>	No
<b>type of electrical connection</b>	
• for main current circuit	screw-type terminals
<b>arrangement of electrical connectors for main current circuit</b>	Top and bottom
<b>type of connectable conductor cross-sections</b>	
• for main contacts	
— solid or stranded	2x (0,75 ... 2,5 mm <sup>2</sup> ), 2x 4 mm <sup>2</sup>
— finely stranded with core end processing	2x (0.5 ... 1.5 mm <sup>2</sup> ), 2x (0.75 ... 2.5 mm <sup>2</sup> )
• for AWG cables for main contacts	2x (18 ... 14), 2x 12
<b>connectable conductor cross-section for main contacts</b>	
• solid or stranded	0.75 ... 4 mm <sup>2</sup>
• finely stranded with core end processing	0.5 ... 2.5 mm <sup>2</sup>
<b>AWG number as coded connectable conductor cross section for main contacts</b>	18 ... 12
<b>tightening torque</b>	
• for main contacts with screw-type terminals	0.8 ... 1.2 N·m
<b>design of screwdriver shaft</b>	Diameter 5 to 6 mm
<b>size of the screwdriver tip</b>	Pozidriv size 2
<b>design of the thread of the connection screw</b>	
• for main contacts	M3
<b>Safety related data</b>	
product function suitable for safety function	Yes
<b>suitability for use</b>	
• safety-related switching on	No
• safety-related switching OFF	Yes
<b>service life maximum</b>	10 a
<b>test wear-related service life necessary</b>	Yes
<b>proportion of dangerous failures</b>	
• with low demand rate according to SN 31920	40 %
• with high demand rate according to SN 31920	50 %
<b>B10 value with high demand rate according to SN 31920</b>	5 000
<b>failure rate [FIT] with low demand rate according to SN 31920</b>	50 FIT
ISO 13849	
<b>device type according to ISO 13849-1</b>	3
<b>overdimensioning according to ISO 13849-2 necessary</b>	Yes
IEC 61508	
<b>safety device type according to IEC 61508-2</b>	Type A

<b>T1 value</b> <ul style="list-style-type: none"> <li>for proof test interval or service life according to IEC 61508</li> </ul>	10 a
---	------

**Electrical Safety**

<b>protection class IP on the front according to IEC 60529</b>	IP20
--	------

<b>touch protection on the front according to IEC 60529</b>	finger-safe, for vertical contact from the front
---	--

**Display**

display version for switching status	Handle
--------------------------------------	--------





**Approvals Certificates**

**Environmental Product Declaration**

<ul style="list-style-type: none"> <li>global warming potential [CO2 eq] / during manufacturing</li> </ul>	1.98 kg
<ul style="list-style-type: none"> <li>global warming potential [CO2 eq] / during sales</li> </ul>	0.134 kg
<ul style="list-style-type: none"> <li>global warming potential [CO2 eq] / during operation</li> </ul>	72.7 kg
<ul style="list-style-type: none"> <li>global warming potential [CO2 eq] / after end of life</li> </ul>	-0.116 kg
<ul style="list-style-type: none"> <li>global warming potential [CO2 eq] / total</li> </ul>	74.698 kg

**Environment      General Product Approval**

[Environmental Conformations](#)



**General Product Approval**









**For use in hazardous locations      Test Certificates      Maritime application**

[Special Test Certificate](#)

[Type Test Certificates/Test Report](#)

**Maritime application      other**







[Miscellaneous](#)

[Confirmation](#)

**other      Railway**

[Miscellaneous](#)



[Confirmation](#)

[Special Test Certificate](#)

**Further information**

Information on the packaging  
<https://support.industry.siemens.com/cs/ww/en/view/109813875>  
 Information for data generation and storage  
<https://support.industry.siemens.com/cs/ww/en/view/109995012>  
 Information- and Downloadcenter (Catalogs, Brochures,...)  
<https://www.siemens.com/ic10>  
 Industry Mall (Online ordering system)  
<https://mall.industry.siemens.com/mall/en/en/Catalog/product?mifb=3RV2011-1GA10>  
 Service&Support (Manuals, Certificates, Characteristics, FAQs,...)  
<https://support.industry.siemens.com/cs/ww/en/ps/3RV2011-1GA10>  
 Image database (product images, 2D dimension drawings, 3D models, device circuit diagrams, EPLAN macros, ...)

[https://www.automation.siemens.com/bilddb/cax\\_de.aspx?mlfb=3RV2011-1GA10&lang=en](https://www.automation.siemens.com/bilddb/cax_de.aspx?mlfb=3RV2011-1GA10&lang=en)

Cax online generator

<https://support.automation.siemens.com/WW/CAXorder/default.aspx?lang=en&mlfb=3RV2011-1GA10>

Characteristic curves

[https://curves.simaris.siemens.com/curves/<mmp\\_prod\\_noCOMP='HAUPT'></mmp\\_prod\\_no>](https://curves.simaris.siemens.com/curves/<mmp_prod_noCOMP='HAUPT'></mmp_prod_no>)

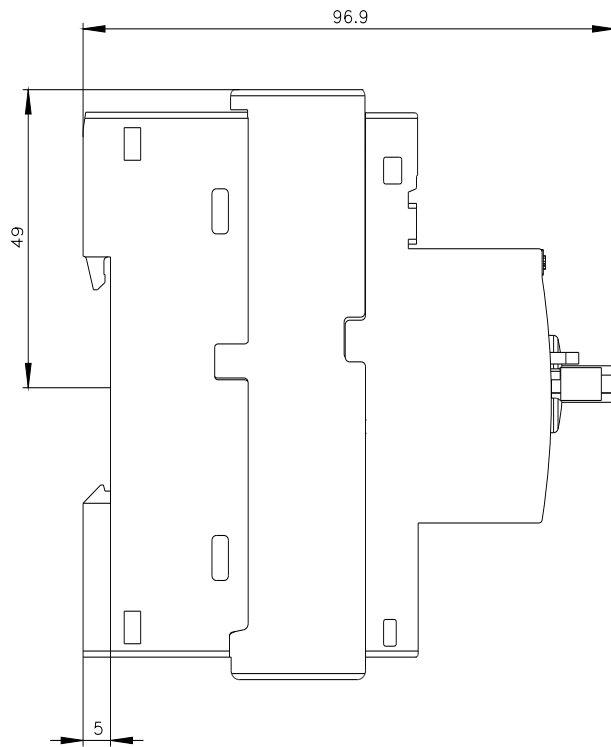
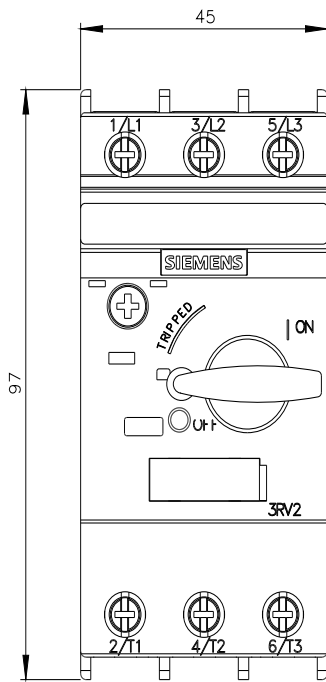

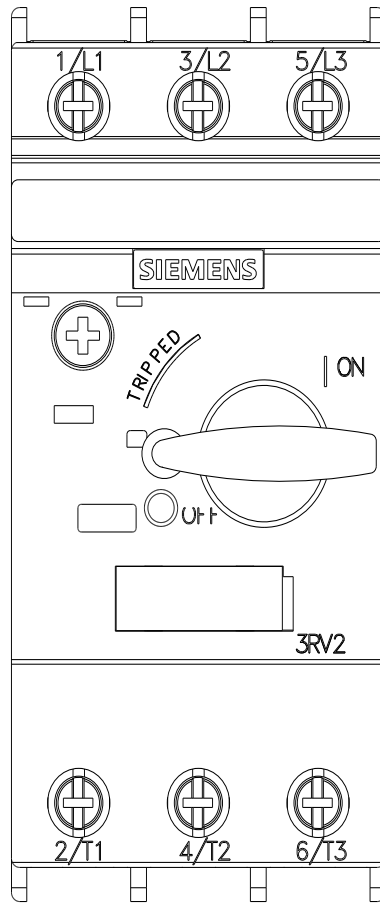

last modified:

5/5/2026 ↻