



SELV



■ Features

- EIB / KNX power supply with integrated choke
- Compact size with 3SU(52.5mm) width
- Safety extra low voltage(SELV)
- 180~264VAC input
- No load power consumption <0.5W
- Protections: Short circuit / Overload(short-circuit-proof) / Over voltage
- Cooling by free air convection
- Isolation class I
- LED indicator for normal operation, bus reset and bus overload
- Installed on DIN rail TS-35/7.5 or 15
- 100% full load burn-in test
- 3 years warranty

■ Applications

- Intelligent home control
- Modern building automation
- Lighting control
- HVAC system
- Security system
- Blinds and shutters
- Monitoring systems
- Energy management
- Alarm monitoring

■ Description

The KNX Power Supply KNX-20E is a 640mA power supply with high efficiency and a small footprint of only 3SU (52.5 mm). The device has a KNX bus choke output and an additional output for ancillary power. The -30~+70°C wide temperature operating range can meet all kinds of applications. LED indicators are used in case of normal operation, overload conditions and RESET operation. It is perfectly suitable to power up any products labeled with the KNX trademark. With over 30 years of industrial power supply experience, KNX-20E is engineered to be a reliable and safe solution for KNX bus environment.

■ Model Encoding

KNX - 20E - 640

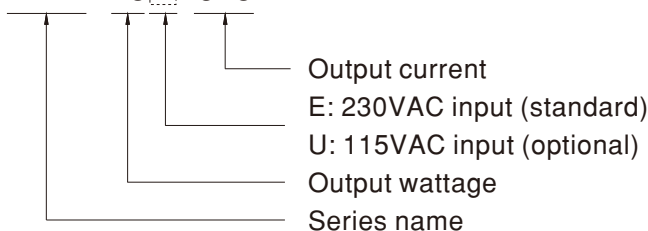



SPECIFICATION

MODEL		KNX-20E-640
OUTPUT	BUS OUTPUT VOLTAGE WITH CHOKE	Bus,30V (KNX black/red terminal block)
	DC OUTPUT VOLTAGE WITHOUT CHOKE	30V(Additional output for ancillary power)
	RATED CURRENT	640mA
	RATED POWER	19.2W
	RIPPLE & NOISE (max.) Note.2	100mVp-p
	SHORT CIRCUIT CURRENT	1.4A
	SETUP, RISE TIME	1000ms, 50ms/230VAC at full load
	AC MAINS FAILURE BACK-UP TIME(Typ.)	200ms/230VAC at full load
INPUT	VOLTAGE RANGE	180 ~ 264VAC 254 ~ 370VDC
	FREQUENCY RANGE	47 ~ 63Hz
	EFFICIENCY (Typ.) Note.3	86%
	AC CURRENT (Typ.)	0.22A/230VAC
	INRUSH CURRENT (Typ.)	COLD START 40A/230VAC
	LEAKAGE CURRENT	<1mA / 240VAC
PROTECTION	OVERLOAD	205 ~ 235% rated output power Protection type : Constant current limiting, recovers automatically after fault condition is removed
	OVER VOLTAGE	33 ~ 35V Protection type : Shut down o/p voltage, re-power on to recover
FUNCTION	RESET	Physical button for reset the bus (Press the RESET button for at least 20 seconds to reset the KNX Bus)
	LED DISPLAY	Green LED (ON) :Normal operation Red LED1 (Reset):Reset the bus; Red LED2 ($I > I_{max}$):Overload/Short
	CHOKE	One integrated choke
ENVIRONMENT	WORKING TEMP.	-30 ~ +70°C (Refer to "Derating Curve")
	WORKING HUMIDITY	20 ~ 95% RH non-condensing
	STORAGE TEMP., HUMIDITY	-40 ~ +85°C, 10 ~ 95% RH
	VIBRATION TYPE OF PROTECTION	10 ~ 500Hz, 2G 10min./1cycle, 60min. each along X, Y, Z axes
	TYPE OF PROTECTION	IP20 design
SAFETY & EMC (Note 4)	SAFETY STANDARDS	EN61558-1,EN61558-2-16 approved
	WITHSTAND VOLTAGE	I/P-O/P:3.75KVAC I/P-FG:2KVAC O/P-FG:1.25KVAC
	ISOLATION RESISTANCE	I/P-O/P, I/P-FG:100M Ohms / 500VDC / 25°C / 70% RH
	EMC EMISSION	Compliance to EN50491-5-2,-5-3; EN50491-3; EN61000-3-2,-3-3
	EMC IMMUNITY	Compliance to EN50491-5-2,-5-3; EN61000-4-2,3,4,5,6,8,11, heavy industry level, criteria A
OTHERS	MTBF	109K hrs min. MIL-HDBK-217F (25°C)
	DIMENSION	52.5*90*54.5mm (W*H*D)
	MOUNTING	35mm mounting rail according to DIN EN60715
	PACKING	0.215Kg ; 60pcs/13.9Kg/0.97CUFT
NOTE	<p>1. All parameters NOT specially mentioned are measured at 230VAC input, rated load and 25°C of ambient temperature.</p> <p>2. Ripple & noise are measured at 20MHz of bandwidth by using a 12" twisted pair-wire terminated with a 0.1uF & 47uF parallel capacitor. Measure before Choke.</p> <p>3. Efficiency before choke.</p> <p>4. The power supply is considered a component which will be installed into a final equipment. The final equipment must be re-confirmed that it still meets EMC directives. For guidance on how to perform these EMC tests, please refer to "EMI testing of component power supplies." (as available on http://www.meanwell.com)</p>	

Block Diagram

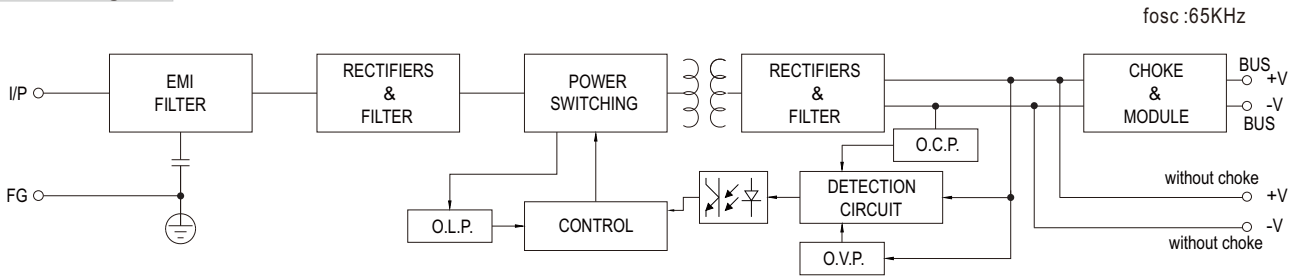

Derating Curve

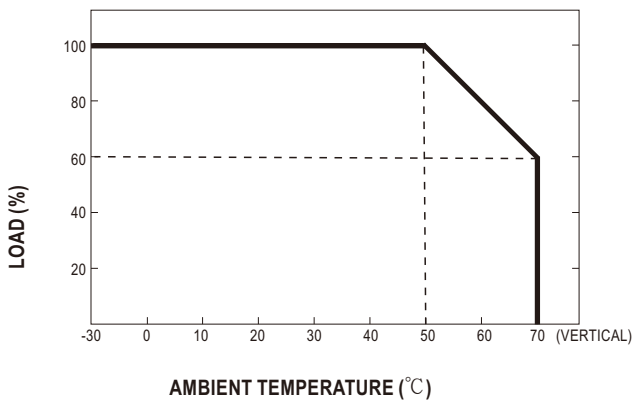

Static Characteristics

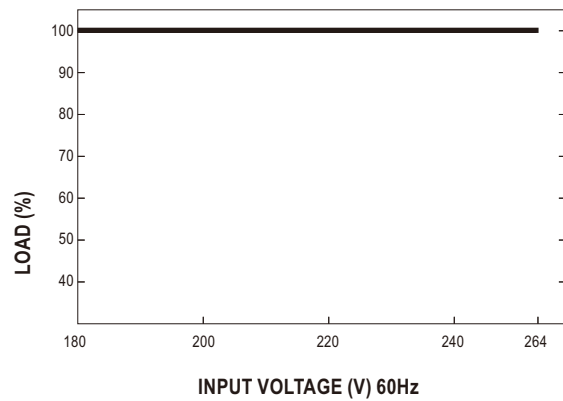

Mechanical Specification

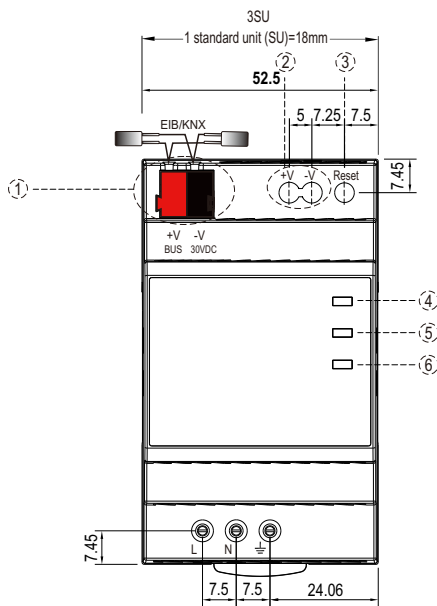

Case No. KNX-20 Unit:mm

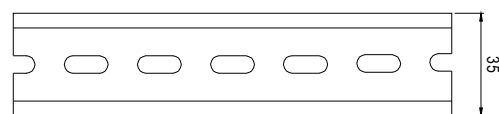
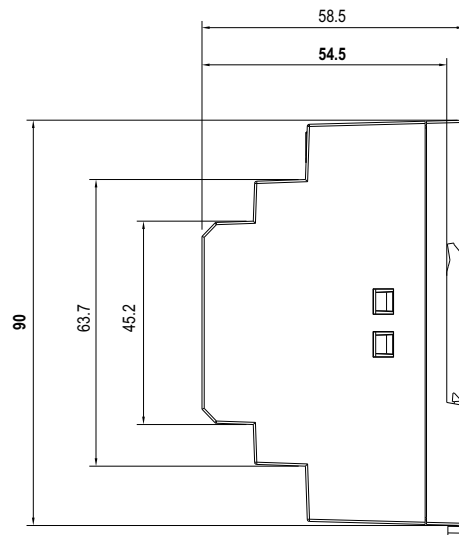

ADMISSIBLE DIN-RAIL: TS35/7.5 OR TS35/15

1	KNX bus terminals (Red :+, Black:-)
2	Ancillary power terminals
3	Reset button
4	Power ON (Green)
5	Reset (Red)
6	I > I max (Red)

■ Configuration and Commissioning

The device does not need any configuration or application program.

■ Typical application

◎ Application 1: Powering KNX Bus Only

KNX Bus

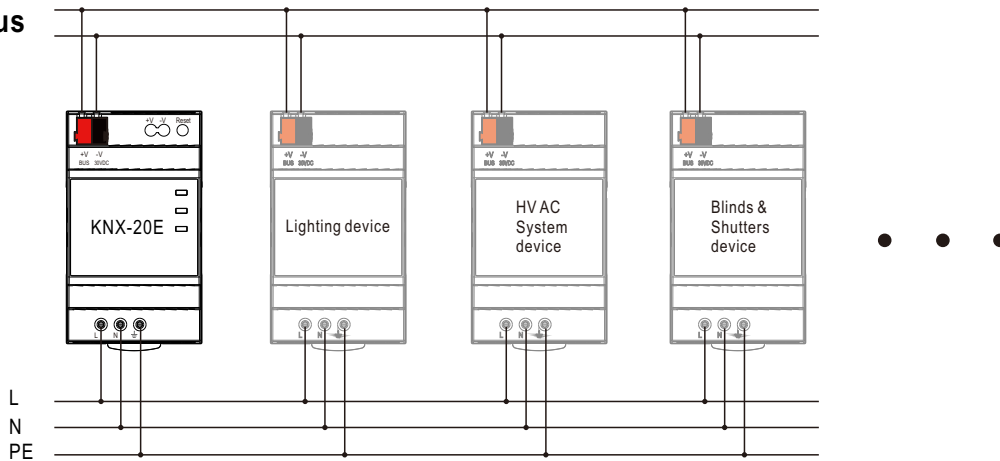

Bus wiring consideration:

1. the maximum number of bus devices connected is 64.
2. the maximum length of a line segment is 350 m, measured along the line between the power supply and the furthest device bus.
3. the maximum distance between two bus devices cannot exceed 700 m
4. the maximum length of a bus line is 1000 m, keeping into account all segments

◎ Application 2: Powering KNX Bus and KNX device

KNX Bus

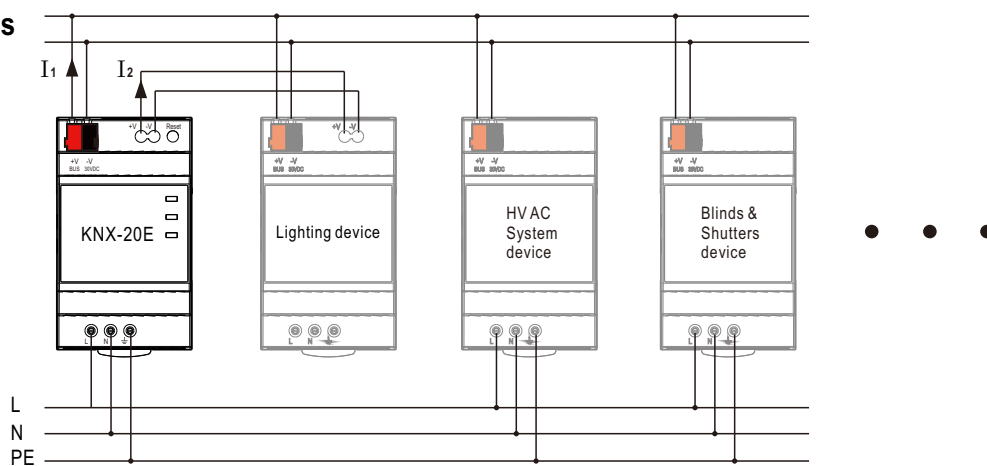

Note:

1. Use only ancillary output of KNX-20E to power the KNX device
2. The total current $I_1 + I_2$ should be equal or less than 640mA. $I_1 + I_2 \leq 640\text{mA}$
3. The above Bus wiring consideration is still applicable

■ Recommended Screwdriver, Wire and Torque Setting

1. Screwdriver(Width*Thick): Slotted screwdriver 2.5*0.4~3.5*0.6
2. Wire: 0.5~4.0mm² solid core or 0.5~2.5mm² finely stranded
3. Torque: 0.8Nm

■ Installation Manual

Please refer to : <http://www.meanwell.com/webnet/search/InstallationSearch.html>