







835 Series, 5x20 mm, Time-Lag Fuse



Agency Approvals

Agency	Agency File Number	Ampere Range
	R50282025	5A-8A
	SU05001-14001 SU05001-14002	5A-6.3A 8A
	CQC14012115993	8A
	2014010207723515	5A-6.3A
	E10480	5A-8A
	Cartridge: NBK080205-E10480A NBK250702-E10480E Leaded: NBK080205-E10480B NBK250702-E10480F	5A 6.3A-8A 5A 6.3A-8A

Transient Surge Ratings

Surge Wave Form	Short-Circuit Current	Number of Pulses	Ampere Rating
8/20 μ s ²	1,500A	12	5A-8A

Notes:

- Transient surge ratings are provided for reference only and may not represent surge withstand capability in the end application. Factors including, but not limited to, series impedance, mounting, and wiring may affect surge withstand capability.
- In accordance with IEC 60060-1, front time = 8 μ s and time to half-value = 20 μ s

Description

The 835 Series is a 5x20mm time-lag, ceramic body AC fuse with higher I²t, high interrupting rating, and 1.5kA surge withstand capability. This series fuse provides enhanced over-current protection and surge withstand capability, ideal for LED/LCDDTVs, digital display systems, and digital signage type of display applications. It is RoHS compliant and 100% Pb-Free.

Features

- Higher I²t and 1.5kA Surge Withstand Capability
- High breaking capacity
- Operating temperature range from -55°C to 125°C
- Meet the IEC 60127-2, sheet 5 specifications for Time-Lag Fuses
- RoHS compliant and Lead-free

Applications

- LED/LCDDTVs
- Digital Display Systems
- Digital Signage
- White Goods
- Power Supply Units

Electrical Characteristics for Series

% of Ampere Rating	Ampere Rating	Opening Time
150%	5A- 6.3A	60 minutes, Minimum
	8A	30 minutes, Minimum
210%	5A- 8A	30 minutes, Maximum
275%		.75 sec. Min.; 80 secs. Max.
400%		.150 sec. Min.; 5 secs. Max.
1000%		.010 sec. Min.; .150 sec. Max.

Additional Information



Datasheet



Resources









Samples



Accessories

For recommended fuse accessories for this product series, see '[Recommended Accessories](#)' section.

Electrical Characteristic Specifications by Item

Amp Code	Amp Rating	Voltage Rating (V)	Interrupting Rating	Nominal Cold Resistance (Ohms)	Nominal Melting I ² t (A ² sec)	Agency Approvals					
											
005.	5	250	1500A@250VAC	0.0155	155	x	x	x		x	x
06.3	6.3			0.0118	300	x	x	x		x	x
008.	8			0.0092	230	x	x		x	x	x

I²t tested at 10x rated current

Temperature Derating Curve

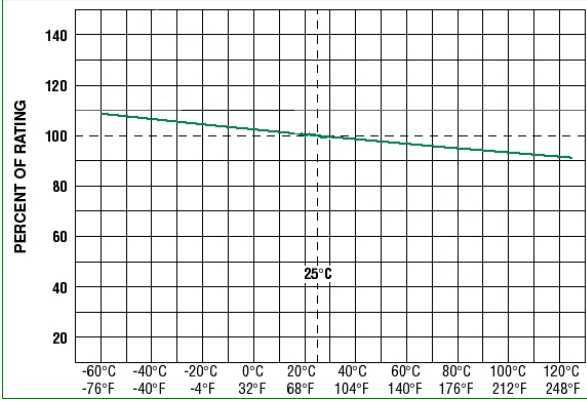

Average Time Current Curves

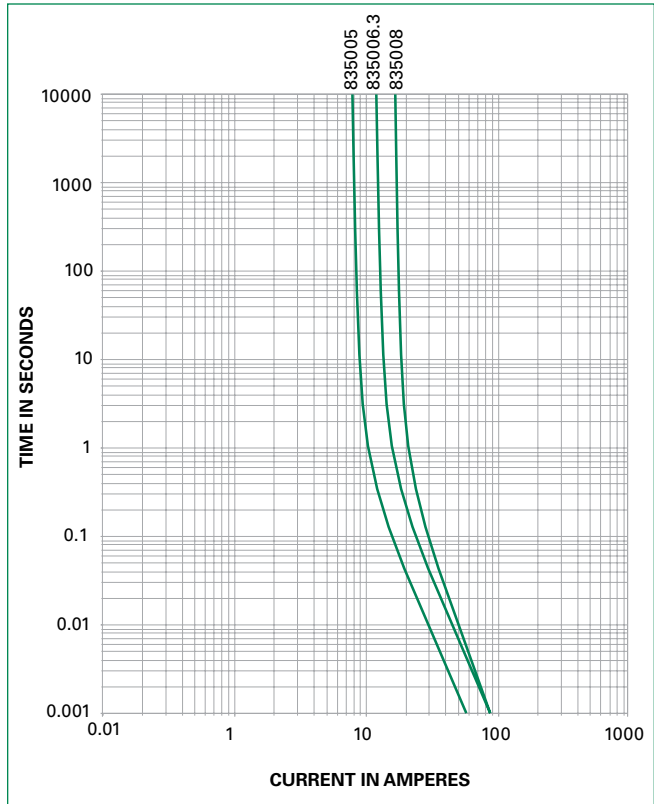

Product Characteristics

Materials	Body: Ceramic Cap: Nickel-plated Brass Leads: Tin-plated Copper
Terminal Strength	MIL-STD-202, Method 211, Test Condition A
Solderability	IEC 60068-2-20, Method 1 (235°C)
Product Marking	Cap 1: Brand logo, current and voltage ratings Cap 2: Agency approval markings
Packaging	Packed 1000 pieces on bulk
Operating Temperature	-55°C to +125°C
Thermal Shock	MIL-STD-202, Method 107, Test Condition B (5 cycles, -65°C to +125°C)
Vibration	MIL-STD-202, Method 201
Humidity	MIL-STD-202, Method 103, Test Condition A: High relative humidity (95%) and elevated temperature (40°C) for 240 hours
Salt Spray	MIL-STD-202, Method 101, Test Condition B

Soldering Parameters - Wave Soldering

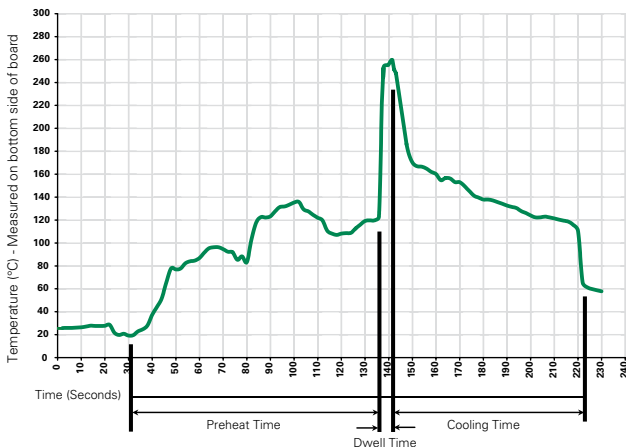

Recommended Process Parameters:

Wave Parameter	Lead-Free Recommendation
Preheat: (Depends on Flux Activation Temperature)	(Typical Industry Recommendation)
Temperature Minimum:	100°C
Temperature Maximum:	150°C
Preheat Time:	60-180 seconds
Solder Pot Temperature:	260°C Maximum
Solder Dwell Time:	2-5 seconds

Recommended Hand-Solder Parameters:

Solder Iron Temperature: 350°C +/- 5°C
Heating Time: 5 seconds max.

Note: These devices are not recommended for IR or Convection Reflow process.

Dimensions

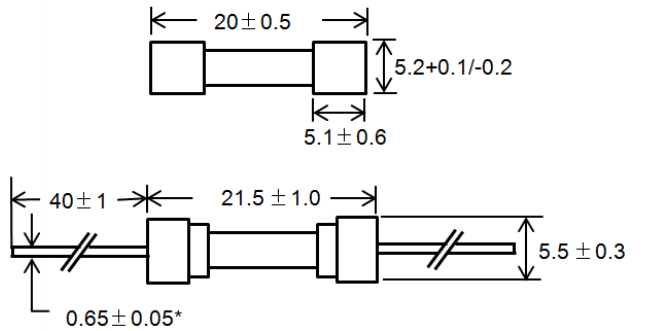

All dimensions in mm

*Ratings above 6.3A have 0.8±0.05mm diameter lead

Part Numbering System

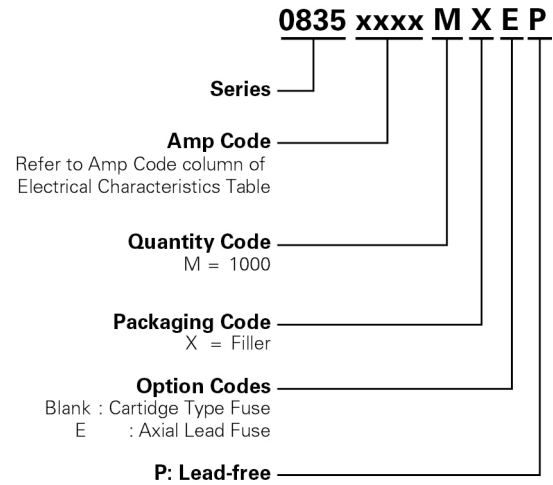

Packaging

Packaging Option	Packaging Specification	Quantity	Quantity & Packaging Code	Reel Size
835 Series				
Bulk	N/A	1000	MX	N/A
Bulk	N/A	1000	MXE	N/A
Bulk (Color Coding & forming)	N/A	1000	MXK	N/A

Recommended Accessories

Accessory Type	Series	Description	Max Application Voltage	Max Application Amperage
Holder	345_ISF	Panel Mount Shock-Safe Fuseholder	250	10
	345	Shock-Safe Fuseholder with PC Mount, Solder Mount and Panel Mount options		20
	830	PC Mount Shock-Safe Miniature Fuseholder		16
Block	520	Metric OMNI-BLOK® Fuse Block		10
	646	PC Mount Miniature Fuse Block		6.3
	658	Surface Mount Miniature Fuse Block		10
Clip	520_W	PC Mount Miniature Fuse Clip		6.3
	111	PC Board Mount Fuse Clip	10	
	445	PC Board Mount Fuse Clip	10	

- Notes:
- Do not use in applications above rating.
 - Please refer to fuseholder data sheet for specific re-rating information.
 - Please contact factory for applications greater than the max voltage and amperage shown.