



IQ40-40NPPKK0S

IQG

INDUCTIVE PROXIMITY SENSORS

SICK
Sensor Intelligence.



Ordering information

| Type | Part no. |
|---------------|----------|
| IQ40-40NPPK0S | 1071863 |

Other models and accessories → www.sick.com/IQG



Detailed technical data

Features

| | |
|---|------------------------|
| Housing | Rectangular |
| Housing | Standard design |
| Dimensions (W x H x D) | 40 mm x 40 mm x 118 mm |
| Sensing range S_n | 40 mm |
| Safe sensing range S_a | 32.4 mm |
| Installation type | Non-flush |
| Switching frequency | 100 Hz |
| Connection type | Cable gland |
| Output type | PNP |
| Output function | Complementary |
| Electrical wiring | DC 4-wire |
| Enclosure rating | IP67, IP68, IP69K |

Mechanics/electronics

| | |
|---|------------------------------------|
| Supply voltage | 10 V DC ... 30 V DC |
| Ripple | ≤ 10 V _{pp} ¹⁾ |
| Voltage drop | ≤ 2 V |
| Current consumption | ≤ 20 mA ²⁾ |
| Time delay before availability | ≤ 200 ms |
| Hysteresis | 3 % ... 15 % ³⁾ |
| Reproducibility | ≤ 6 % |
| Temperature drift (of S_r) | ± 10 % |
| Continuous current I_a | ≤ 200 mA |
| Short-circuit protection | ✓ |

¹⁾ Of U_b.

²⁾ Without load.

³⁾ Of S_r.

⁴⁾ Reference voltage: 50 V DC.

| | |
|---------------------------------------|----------------------------------|
| Reverse polarity protection | ✓ |
| Power-up pulse protection | ✓ |
| Shock and vibration resistance | 30 g, 11 ms / 10 ... 55 Hz, 1 mm |
| Ambient operating temperature | -25 °C ... +85 °C |
| Ambient storage temperature | -40 °C ... +85 °C |
| Housing material | Plastic, PA 66 |
| Sensing face material | Plastic, PA 66 |
| Tightening torque, max. | 1.8 Nm |
| Protection class | II ⁴⁾ |
| UL File No. | E348498 |

¹⁾ Of Ub.

²⁾ Without load.

³⁾ Of S_r.

⁴⁾ Reference voltage: 50 V DC.

Reduction factors

| | |
|-----------------------------------|--|
| Note | The values are reference values which may vary |
| Stainless steel (V2A, 304) | Approx. 0.8 |
| Aluminum (Al) | Approx. 0.34 |
| Copper (Cu) | Approx. 0.27 |
| Brass (Br) | Approx. 0.38 |

Installation note

| | |
|---------------|---------------------------------------|
| Remark | Associated graphic see "Installation" |
| A | 42 mm |
| B | 100 mm |
| C | 40 mm |
| D | 120 mm |
| E | 40 mm |
| F | 150 mm |

Classifications

| | |
|-----------------------|----------|
| ECl@ss 5.0 | 27270101 |
| ECl@ss 5.1.4 | 27270101 |
| ECl@ss 6.0 | 27270101 |
| ECl@ss 6.2 | 27270101 |
| ECl@ss 7.0 | 27270101 |
| ECl@ss 8.0 | 27270101 |
| ECl@ss 8.1 | 27270101 |
| ECl@ss 9.0 | 27270101 |
| ETIM 5.0 | EC002714 |
| ETIM 6.0 | EC002714 |
| UNSPSC 16.0901 | 39122230 |

Installation note

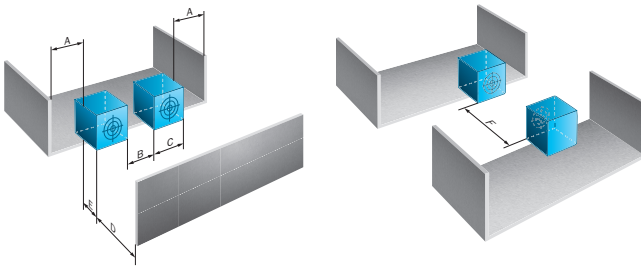

Connection diagram

Cd-030

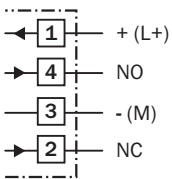

Characteristic curve

IQ40-40Nxxxx

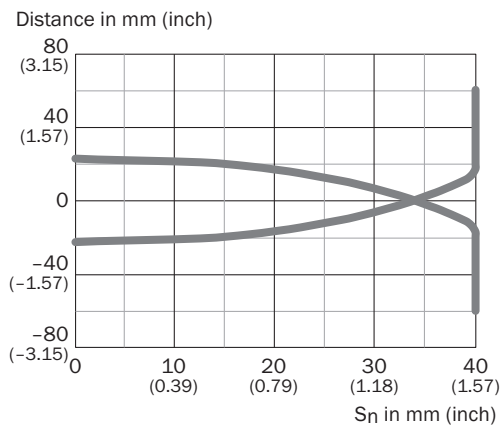

Dimensional drawing (Dimensions in mm (inch))

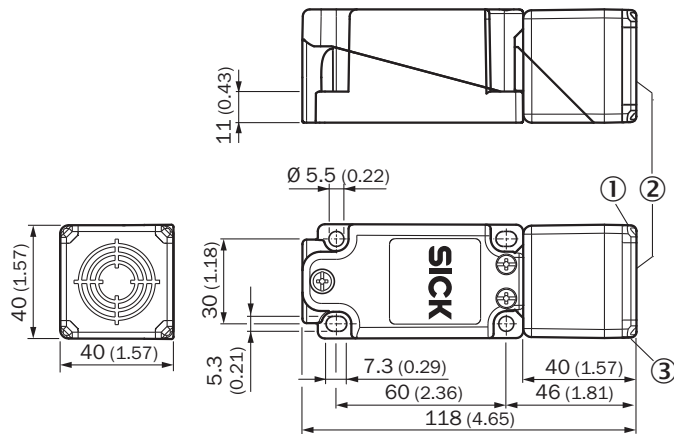

IQG Standard, cable gland



- ① LED output state, yellow
- ② Sensing face
- ③ Operational status LED, green

Recommended accessories

Other models and accessories → www.sick.com/IQG

| | Brief description | Type | Part no. |
|---|--|---------------|----------|
| Plug connectors and cables | | | |
|  | Head A: female connector, M12, 4-pin, straight Head B: cable Cable: PVC, unshielded, 2 m | DOL-1204-G02M | 6009382 |
| | Head A: female connector, M12, 4-pin, straight Head B: cable Cable: PVC, unshielded, 5 m | DOL-1204-G05M | 6009866 |
| | Head A: female connector, M12, 4-pin, straight Head B: cable Cable: PVC, unshielded, 10 m | DOL-1204-G10M | 6010543 |
|  | Head A: female connector, M12, 4-pin, angled with LED Head B: cable Cable: PVC, unshielded, 2 m | DOL-1204-L02M | 6027945 |
| | Head A: female connector, M12, 4-pin, angled with LED Head B: cable Cable: PVC, unshielded, 5 m | DOL-1204-L05M | 6027944 |
| | Head A: female connector, M12, 4-pin, angled with LED Head B: cable Cable: PVC, unshielded, 10 m | DOL-1204-L10M | 6027946 |
|  | Head A: female connector, M12, 4-pin, angled Head B: cable Cable: PVC, unshielded, 2 m | DOL-1204-W02M | 6009383 |
| | Head A: female connector, M12, 4-pin, angled Head B: cable Cable: PVC, unshielded, 5 m | DOL-1204-W05M | 6009867 |

| | Brief description | Type | Part no. |
|---|---|---------------|-----------------|
|  | Head A: female connector, M12, 4-pin, angled Head B: cable Cable: PVC, unshielded, 10 m | DOL-1204-W10M | 6010541 |
| | Head A: female connector, M12, 4-pin, straight Head B: - Cable: unshielded | DOS-1204-G | 6007302 |
|  | Head A: female connector, M12, 4-pin, angled Head B: - Cable: unshielded | DOS-1204-W | 6007303 |

SICK AT A GLANCE

SICK is one of the leading manufacturers of intelligent sensors and sensor solutions for industrial applications. A unique range of products and services creates the perfect basis for controlling processes securely and efficiently, protecting individuals from accidents and preventing damage to the environment.

We have extensive experience in a wide range of industries and understand their processes and requirements. With intelligent sensors, we can deliver exactly what our customers need. In application centers in Europe, Asia and North America, system solutions are tested and optimized in accordance with customer specifications. All this makes us a reliable supplier and development partner.

Comprehensive services complete our offering: SICK LifeTime Services provide support throughout the machine life cycle and ensure safety and productivity.

For us, that is “Sensor Intelligence.”

WORLDWIDE PRESENCE:

Contacts and other locations –www.sick.com