

GRL18S-P235W

GR18S

PHOTOELECTRIC SENSORS

SICK
Sensor Intelligence.



Ordering information

| Type | Part no. |
|--------------|----------|
| GRL18S-P235W | 1064162 |

Other models and accessories → www.sick.com/GR18S

Illustration may differ



Detailed technical data

Features

| | |
|--|--|
| Sensor/detection principle | Photoelectric retro-reflective sensor, Dual lens |
| Housing design (light emission) | Cylindrical, angled, fully flush |
| Thread diameter (housing) | M18 x 1 |
| Optical axis | Radial, fully flush |
| Sensing range max. | 0.03 m ... 7.2 m ¹⁾ |
| Sensing range | 0.06 m ... 6 m ¹⁾ |
| Type of light | Visible red light |
| Light source | PinPoint LED ²⁾ |
| Light spot size (distance) | Ø 175 mm (7 m) |
| Wave length | 650 nm |
| Adjustment | None |

¹⁾ Reflector PL80A.

²⁾ Average service life: 100,000 h at T_J = +25 °C.

Mechanics/electronics

| | |
|--------------------------|-----------------------------------|
| Supply voltage | 10 V DC ... 30 V DC ¹⁾ |
| Ripple | ± 5 V _{pp} ²⁾ |
| Power consumption | ≤ 30 mA |

¹⁾ Limit values when operated in short-circuit protected network: max. 8 A.

²⁾ May not exceed or fall below U_v tolerances.

³⁾ At U_v > 24 V or ambient temperature > 49 °C, I_A max. = 50 mA.

⁴⁾ Signal transit time with resistive load.

⁵⁾ With light/dark ratio 1:1.

⁶⁾ A = V_S connections reverse-polarity protected.

⁷⁾ B = inputs and output reverse-polarity protected.

⁸⁾ D = outputs overcurrent and short-circuit protected.

⁹⁾ At U_v ≤ 24V and I_A < 50mA.

| | |
|---|--|
| Output type | PNP |
| Switching mode | Light switching |
| Signal voltage PNP HIGH/LOW | $V_S - (\leq 3 \text{ V}) / \text{approx. } 0 \text{ V}$ |
| Output current I_{max} | 100 mA ³⁾ |
| Response time | < 500 μs ⁴⁾ |
| Switching frequency | $\pm 1,000 \text{ Hz}$ ⁵⁾ |
| Connection type | Connector M12, 3-pin |
| Circuit protection | A ⁶⁾ B ⁷⁾ D ⁸⁾ |
| Protection class | III |
| Polarisation filter | ✓ |
| Housing material | Nickel-plated brass and ABS |
| Optics material | Plastic, PMMA |
| Enclosure rating | IP67 |
| Items supplied | Fastening nuts (2 x), Reflector P250 |
| EMC | EN 60947-5-2 |
| Ambient operating temperature | -25 °C ... +55 °C ⁹⁾ |
| Ambient storage temperature | -40 °C ... +70 °C |
| UL File No. | NRKH.E348498 & NRKH7.E348498 |

1) Limit values when operated in short-circuit protected network: max. 8 A.

2) May not exceed or fall below U_V tolerances.

3) At $U_V > 24 \text{ V}$ or ambient temperature > 49 °C, $I_A \text{ max.} = 50 \text{ mA}$.

4) Signal transit time with resistive load.

5) With light/dark ratio 1:1.

6) A = V_S connections reverse-polarity protected.

7) B = inputs and output reverse-polarity protected.

8) D = outputs overcurrent and short-circuit protected.

9) At $U_V \leq 24 \text{ V}$ and $I_A < 50 \text{ mA}$.

Classifications

| | |
|-----------------------|----------|
| ECl@ss 5.0 | 27270902 |
| ECl@ss 5.1.4 | 27270902 |
| ECl@ss 6.0 | 27270902 |
| ECl@ss 6.2 | 27270902 |
| ECl@ss 7.0 | 27270902 |
| ECl@ss 8.0 | 27270902 |
| ECl@ss 8.1 | 27270902 |
| ECl@ss 9.0 | 27270902 |
| ETIM 5.0 | EC002717 |
| ETIM 6.0 | EC002717 |
| UNSPSC 16.0901 | 39121528 |

Connection diagram

Cd-045

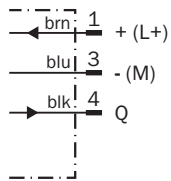

Characteristic curve

GRL18S

Operating reserve

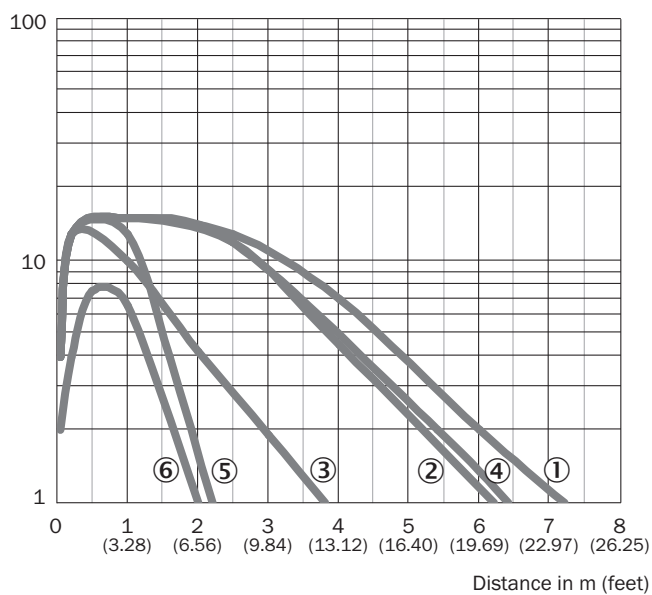

- ① Reflector PL80A
- ② Reflector PL40A
- ③ Reflector PL20A
- ④ Reflector P250
- ⑤ Reflector PL22
- ⑥ Reflective tape REF-Plus 3436

Light spot size

GRL18S

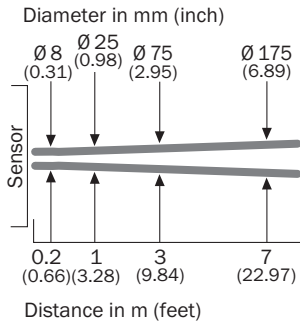

Sensing range diagram

GRL18S

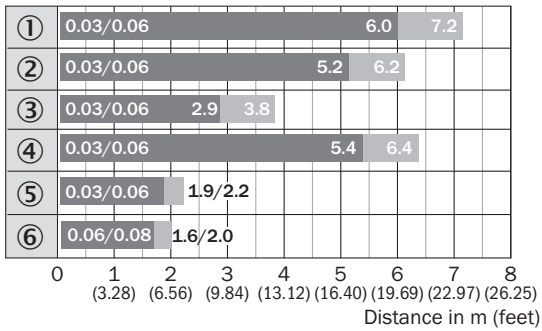

■ Sensing range ■ Sensing range max.

- ① Reflector PL80A
- ② Reflector PL40A
- ③ Reflector PL20A
- ④ Reflector P250
- ⑤ Reflector PL22
- ⑥ Reflective tape REF-Plus 3436

Dimensional drawing (Dimensions in mm (inch))



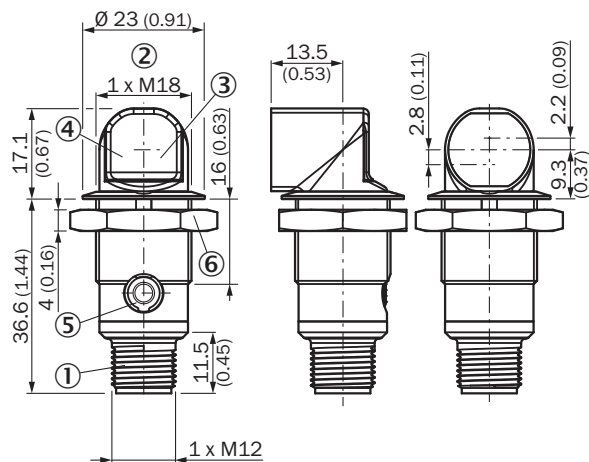

GR18S, metal, connector, angled, fully flush





- ① Connector M12, 3-pin
- ② Threaded mounting hole M18 x 1
- ③ LED indicator yellow
- ④ LED indicator green
- ⑤ Dummy plug
- ⑥ Fastening nut; 24 mm hex, metal

Recommended accessories

Other models and accessories → www.sick.com/GR18S





| | Brief description | Type | Part no. |
|---|---|-----------------|----------|
| Universal bar clamp systems | | | |
|  | Plate N06 for universal clamp bracket, M18, Zinc plated steel (sheet), Zinc die cast (clamping bracket), Universal clamp (5322626), mounting hardware | BEF-KHS-N06 | 2051612 |
| Mounting brackets and plates | | | |
|  | Mounting plate for M18 sensors, steel, zinc coated, without mounting hardware | BEF-WG-M18 | 5321870 |
|  | Mounting bracket for M18 sensors, steel, zinc coated, without mounting hardware | BEF-WN-M18 | 5308446 |
| Other mounting accessories | | | |
|  | Mounting tool for "fully flush" variants | BEF-T0-GR18S | 4072132 |
| Terminal and alignment brackets | | | |
|  | Mounting bracket with ball-and-socket, Plastic, mounting hardware included | BEF-WN-M18-ST02 | 5312973 |



| | Brief description | Type | Part no. |
|---|--|----------------|-----------------|
|  | Clamping block for round sensors M18, without fixed stop, plastic (PA12), glass-fiber reinforced, mounting hardware included | BEF-KH-M18 | 2051481 |
| | Clamping block for round sensors M18, with fixed stop, plastic (PA12), glass-fiber reinforced, mounting hardware included | BEF-KHF-M18 | 2051482 |
|  | Integrated adapter, Plastic (PA12) | BEF-WN-MH15-1 | 4039533 |
|  | Mounting ring, Stainless steel, without mounting hardware | BEF-WN-MH15-2V | 4053358 |

Plug connectors and cables

| | | | |
|---|--|---------------|---------|
|  | Head A: female connector, M12, 4-pin, straight Head B: cable Cable: PVC, unshielded, 2 m | DOL-1204-G02M | 6009382 |
| | Head A: female connector, M12, 4-pin, straight Head B: cable Cable: PVC, unshielded, 5 m | DOL-1204-G05M | 6009866 |
|  | Head A: female connector, M12, 4-pin, angled Head B: cable Cable: PVC, unshielded, 2 m | DOL-1204-W02M | 6009383 |
| | Head A: female connector, M12, 4-pin, angled Head B: cable Cable: PVC, unshielded, 5 m | DOL-1204-W05M | 6009867 |
|  | Head A: female connector, M12, 4-pin, straight Head B: - Cable: unshielded | DOS-1204-G | 6007302 |
|  | Head A: female connector, M12, 4-pin, angled Head B: - Cable: unshielded | DOS-1204-W | 6007303 |
|  | Head A: male connector, M12, 4-pin, straight Head B: - Cable: unshielded | STE-1204-G | 6009932 |
|  | Head A: male connector, M12, 4-pin, angled Head B: - Cable: unshielded | STE-1204-W | 6022084 |

Reflectors

| | | | |
|---|---|-------|---------|
|  | Rectangular, screw connection, 47 mm x 47 mm, PMMA/ABS, Screw-on, 2 hole mounting | P250 | 5304812 |
|  | Rectangular, screw connection, 38 mm x 15 mm, PMMA/ABS, Screw-on, 2 hole mounting | PL20A | 1012719 |
|  | Rectangular, screw connection, 56 mm x 28 mm, PMMA/ABS, Screw-on, 2 hole mounting | PL30A | 1002314 |
|  | Rectangular, screw connection, 37 mm x 56 mm, PMMA/ABS, Screw-on, 2 hole mounting | PL40A | 1012720 |
|  | Rectangular, screw connection, 80 mm x 80 mm, PMMA/ABS, Screw-on, 2 hole mounting | PL80A | 1003865 |

| | Brief description | Type | Part no. |
|---|---|------------|----------|
|  | Self-adhesive | REF-IRF-56 | 5314244 |
|  | Round, screw connection, PMMA/ABS, Center hole mounting, screw-on | C110A | 5304549 |

SICK AT A GLANCE

SICK is one of the leading manufacturers of intelligent sensors and sensor solutions for industrial applications. A unique range of products and services creates the perfect basis for controlling processes securely and efficiently, protecting individuals from accidents and preventing damage to the environment.

We have extensive experience in a wide range of industries and understand their processes and requirements. With intelligent sensors, we can deliver exactly what our customers need. In application centers in Europe, Asia and North America, system solutions are tested and optimized in accordance with customer specifications. All this makes us a reliable supplier and development partner.

Comprehensive services complete our offering: SICK LifeTime Services provide support throughout the machine life cycle and ensure safety and productivity.

For us, that is “Sensor Intelligence.”

WORLDWIDE PRESENCE:

Contacts and other locations –www.sick.com