

**Low Noise Silicon Bipolar RF Transistor**

- Low current device suitable e.g. for handhelds
- For high frequency oscillators e.g. DRO for LNB
- For ISM band applications like Automatic Meter Reading, Sensors etc.
- Transit frequency  $f_T = 25$  GHz
- Pb-free (RoHS compliant) and halogen-free package with visible leads
- Qualification report according to AEC-Q101 available

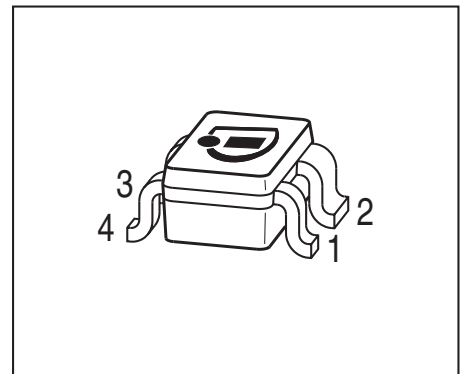

**ESD (Electrostatic discharge) sensitive device, observe handling precaution!**

Type	Marking	Pin Configuration						Package
BFP410	AKs	1=B	2=E	3=C	4=E	-	-	SOT343

**Maximum Ratings** at  $T_A = 25$  °C, unless otherwise specified

Parameter	Symbol	Value	Unit
Collector-emitter voltage	$V_{CEO}$	4.5	V
$T_A = 25$ °C		4.1	
Collector-emitter voltage	$V_{CES}$	13	
Collector-base voltage	$V_{CBO}$	13	
Emitter-base voltage	$V_{EBO}$	1.5	
Collector current	$I_C$	40	mA
Base current	$I_B$	6	
Total power dissipation <sup>1)</sup>	$P_{tot}$	150	mW
$T_S \leq 100$ °C			
Junction temperature	$T_J$	150	°C
Storage temperature	$T_{Stg}$	-55 ... 150	

<sup>1)</sup>  $T_S$  is measured on the emitter lead at the soldering point to the pcb

**Thermal Resistance**

Parameter	Symbol	Value	Unit
Junction - soldering point <sup>1)</sup>	$R_{thJS}$	335	K/W

**Electrical Characteristics at  $T_A = 25\text{ }^\circ\text{C}$ , unless otherwise specified**

Parameter	Symbol	Values			Unit
		min.	typ.	max.	

**DC Characteristics**

Collector-emitter breakdown voltage $I_C = 1\text{ mA}, I_B = 0$	$V_{(BR)CEO}$	4.5	5	-	V
Collector-emitter cutoff current $V_{CE} = 2\text{ V}, V_{BE} = 0$ $V_{CE} = 5\text{ V}, V_{BE} = 0, T_A = 85\text{ }^\circ\text{C}$ (verified by random sampling)	$I_{CES}$	-	1	30	nA
Collector-base cutoff current $V_{CB} = 2\text{ V}, I_E = 0$	$I_{CBO}$	-	1	30	
Emitter-base cutoff current $V_{EB} = 0.5\text{ V}, I_C = 0$	$I_{EBO}$	-	0.001	0.6	$\mu\text{A}$
DC current gain $I_C = 13\text{ mA}, V_{CE} = 2\text{ V}$ , pulse measured	$h_{FE}$	60	95	130	-

<sup>1)</sup>For the definition of  $R_{thJS}$  please refer to Application Note AN077 (Thermal Resistance Calculation)

**Electrical Characteristics at  $T_A = 25\text{ }^\circ\text{C}$ , unless otherwise specified**

Parameter	Symbol	Values			Unit
		min.	typ.	max.	
<b>AC Characteristics (verified by random sampling)</b>					
Transition frequency $I_C = 20\text{ mA}$ , $V_{CE} = 2\text{ V}$ , $f = 2\text{ GHz}$	$f_T$	18	25	-	GHz
Collector-base capacitance $V_{CB} = 2\text{ V}$ , $f = 1\text{ MHz}$ , $V_{BE} = 0$ , emitter grounded	$C_{cb}$	-	0.09	0.17	pF
Collector emitter capacitance $V_{CE} = 2\text{ V}$ , $f = 1\text{ MHz}$ , $V_{BE} = 0$ , base grounded	$C_{ce}$	-	0.35	-	
Emitter-base capacitance $V_{EB} = 0.5\text{ V}$ , $f = 1\text{ MHz}$ , $V_{CB} = 0$ , collector grounded	$C_{eb}$	-	0.45	-	
Minimum noise figure $I_C = 2\text{ mA}$ , $V_{CE} = 2\text{ V}$ , $f = 2\text{ GHz}$ , $Z_S = Z_{Sopt}$	$NF_{min}$	-	1.2	-	dB
Power gain, maximum stable <sup>1)</sup> $I_C = 20\text{ mA}$ , $V_{CE} = 2\text{ V}$ , $Z_S = Z_{Sopt}$ , $Z_L = Z_{Lopt}$ , $f = 2\text{ GHz}$	$G_{ms}$	-	21.5	-	dB
Insertion power gain $V_{CE} = 2\text{ V}$ , $I_C = 20\text{ mA}$ , $f = 2\text{ GHz}$ , $Z_S = Z_L = 50\ \Omega$	$ S_{21} ^2$	-	18.5	-	
Third order intercept point at output <sup>2)</sup> $V_{CE} = 2\text{ V}$ , $I_C = 20\text{ mA}$ , $f = 2\text{ GHz}$ , $Z_S = Z_L = 50\ \Omega$	$IP3$	-	23.5	-	dBm
1dB compression point at output $I_C = 20\text{ mA}$ , $V_{CE} = 2\text{ V}$ , $Z_S = Z_L = 50\ \Omega$ , $f = 2\text{ GHz}$	$P_{-1dB}$	-	10.5	-	

$$^1G_{ms} = |S_{21} / S_{12}|$$

<sup>2</sup>IP3 value depends on termination of all intermodulation frequency components.  
Termination used for this measurement is 50Ω from 0.1 MHz to 6 GHz

**Total power dissipation  $P_{tot} = f(T_S)$**

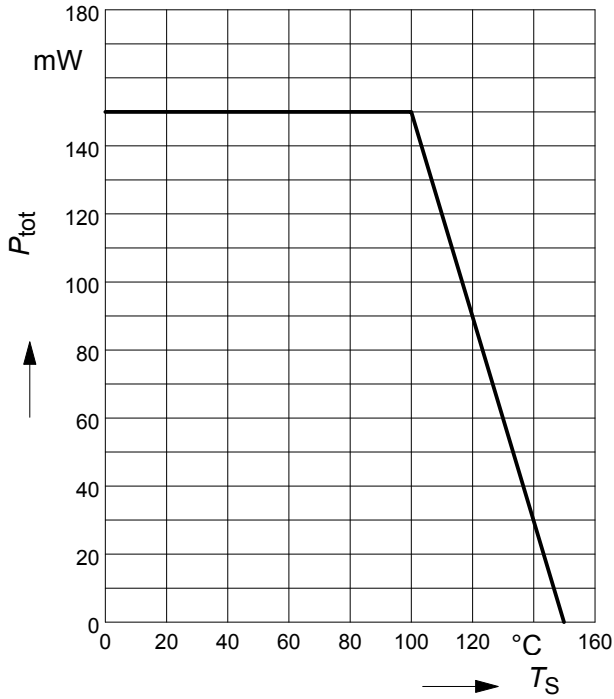

**Collector-base capacitance  $C_{cb} = f(V_{CB})$   
 $f = 1\text{MHz}$**

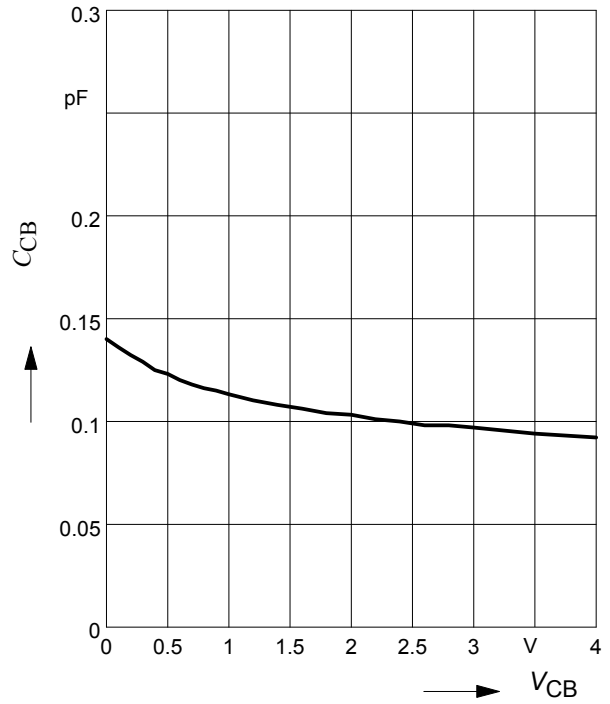

**Transition frequency  $f_T = f(I_C)$**

$f = 2\text{GHz}$

$V_{CE} = \text{parameter in V}$

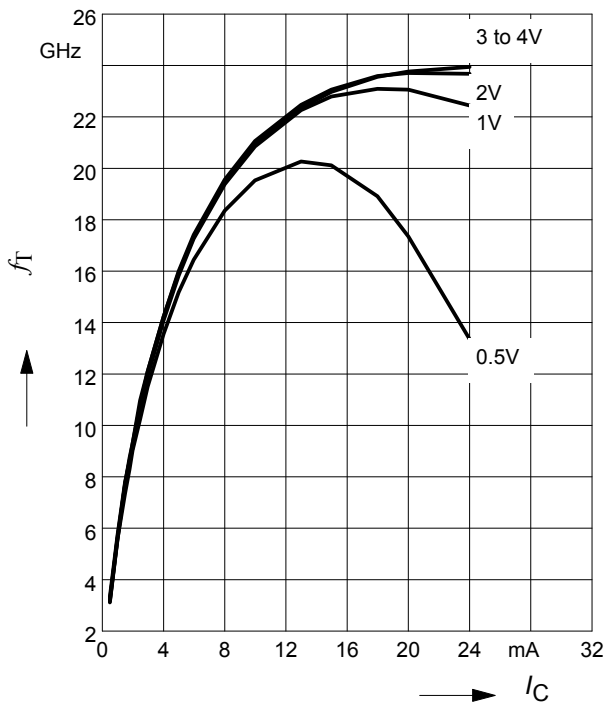

**Power gain  $G_{ma}, G_{ms}, |S_{21}|^2 = f(f)$**

$V_{CE} = 2\text{V}, I_C = 13\text{mA}$

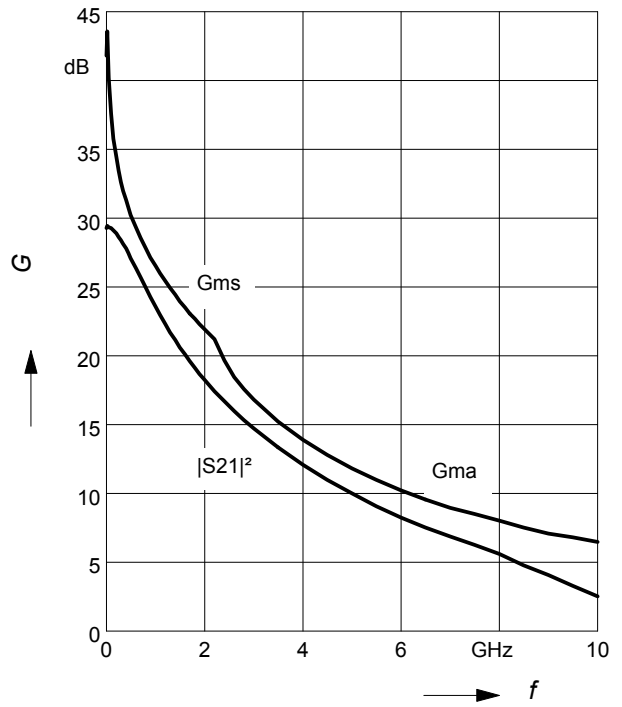

**Power gain  $G_{ma}, G_{ms} = f(I_C)$**

$V_{CE} = 2V$

$f =$  parameter in GHz

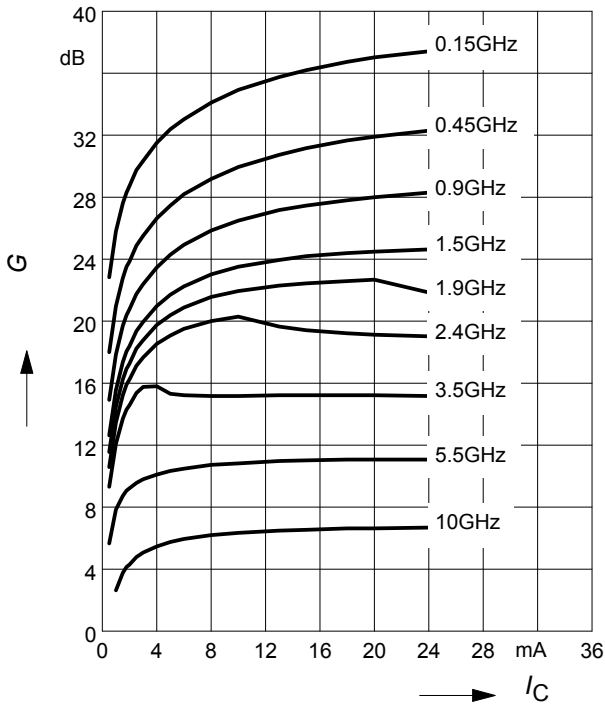

**Power gain  $G_{ma}, G_{ms} = f(V_{CE})$**

$I_C = 13 mA$

$f =$  parameter in GHz

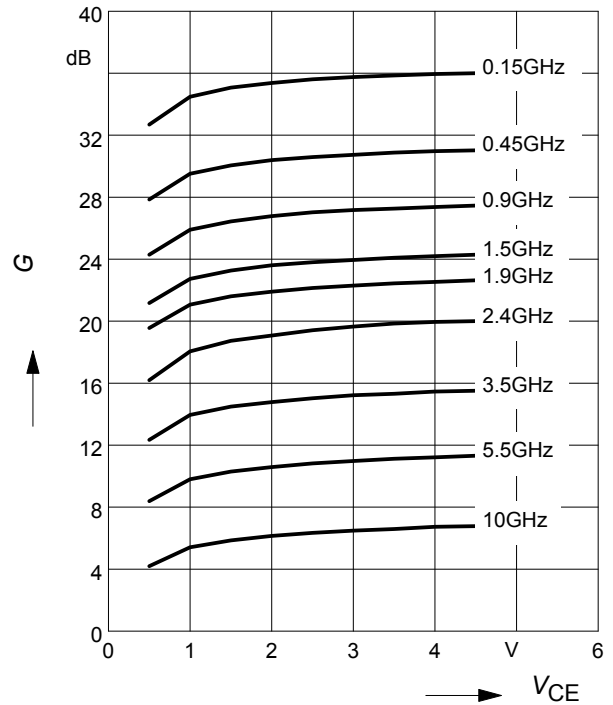

**Noise figure  $F = f(I_C)$**

$V_{CE} = 2 V, Z_S = Z_{Sopt}$

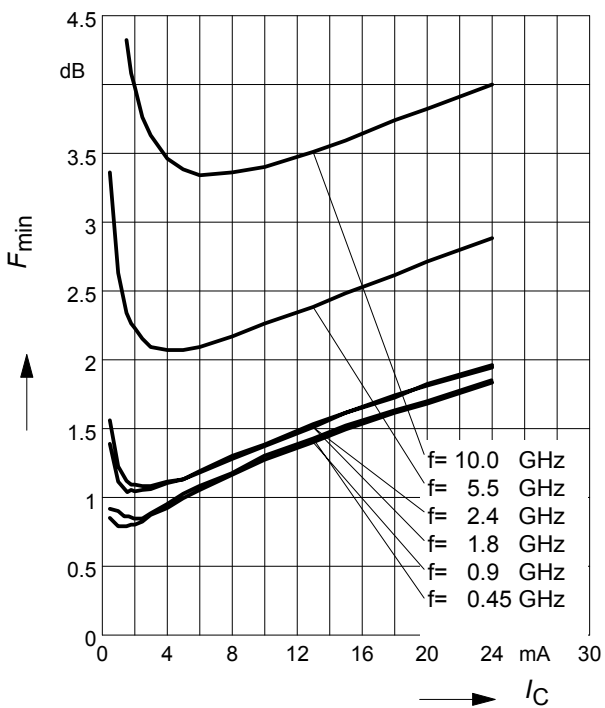

**Noise figure  $F = f(I_C)$**

$V_{CE} = 2 V, f = 2 GHz$

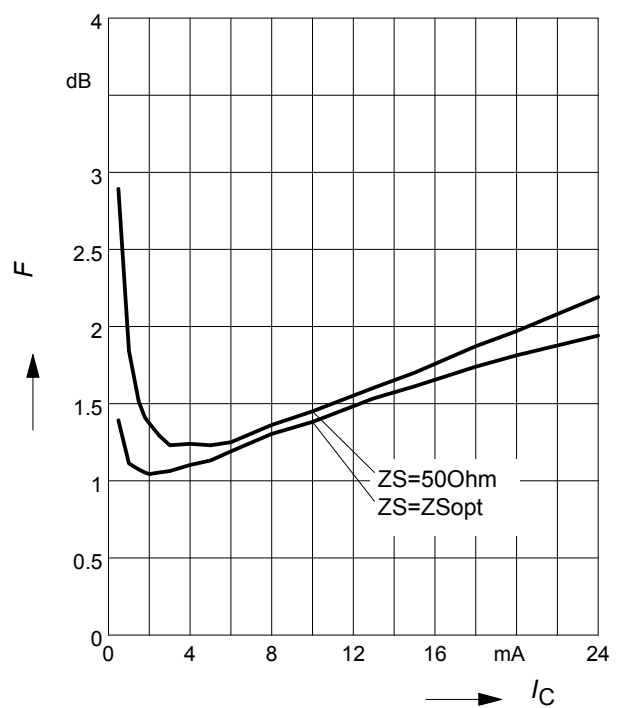

Collector current  $I_C = f(V_{BE})$

$V_{CE} = 2\text{ V}$

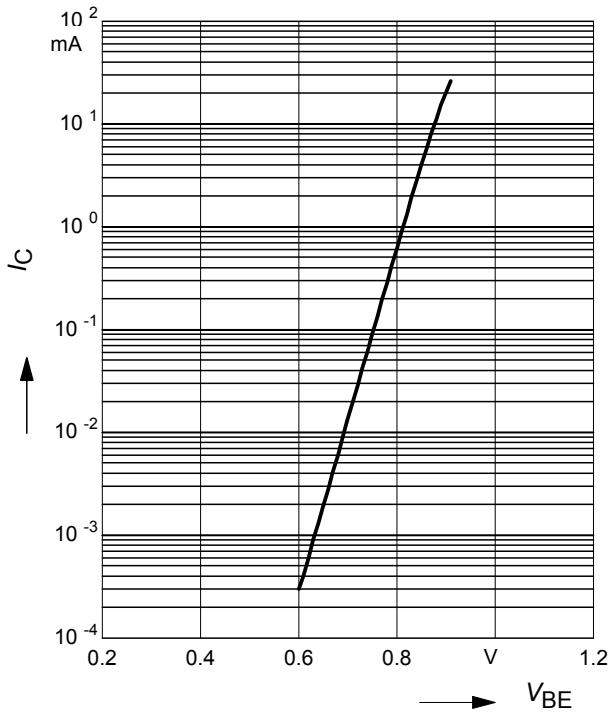

Collector current  $I_C = f(V_{CE})$

Parameter  $I_B$

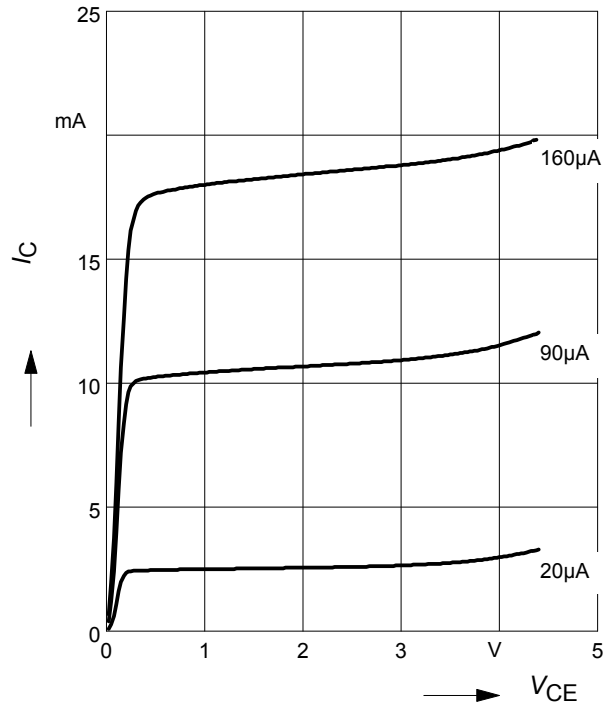

DC current gain  $h_{FE} = f(I_C)$

$V_{CE} = 2\text{ V}$

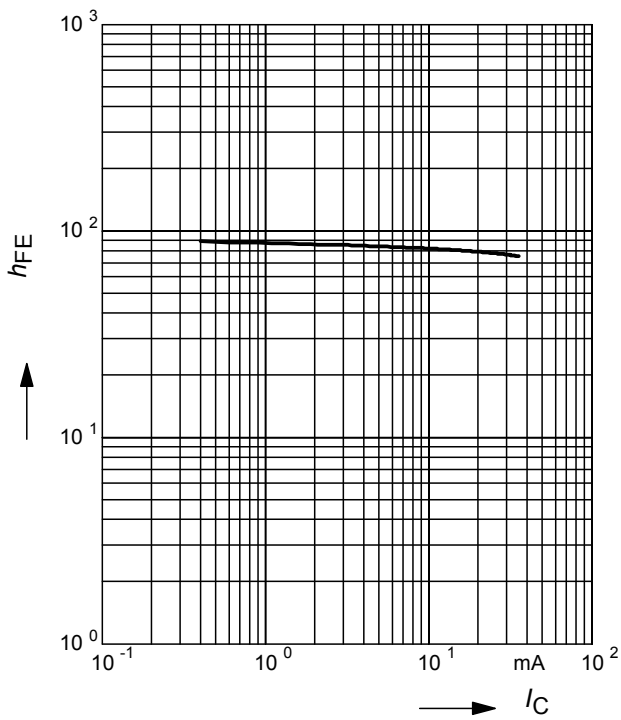

Package Outline

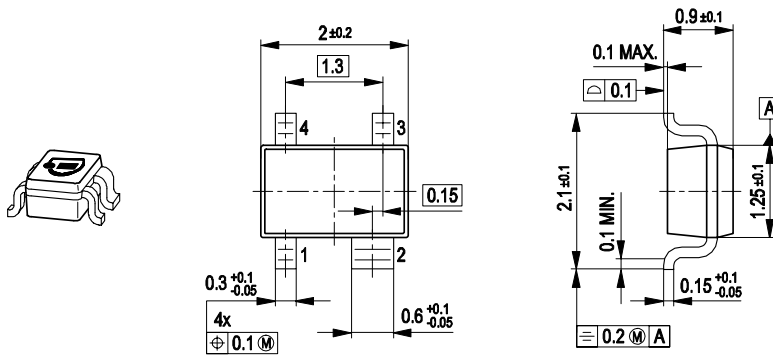

Foot Print

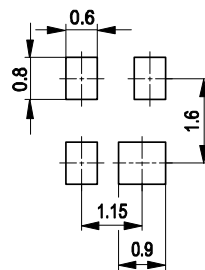

Marking Layout (Example)

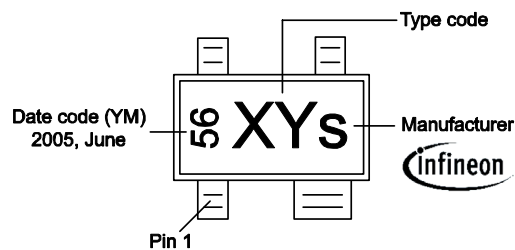

Standard Packing

Reel ø180 mm = 3.000 Pieces/Reel  
 Reel ø330 mm = 10.000 Pieces/Reel

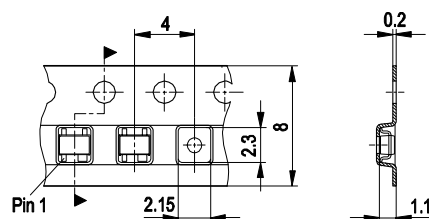

**Edition 2009-11-16**

**Published by  
Infineon Technologies AG  
81726 Munich, Germany**

**© 2009 Infineon Technologies AG  
All Rights Reserved.**

### **Legal Disclaimer**

The information given in this document shall in no event be regarded as a guarantee of conditions or characteristics. With respect to any examples or hints given herein, any typical values stated herein and/or any information regarding the application of the device, Infineon Technologies hereby disclaims any and all warranties and liabilities of any kind, including without limitation, warranties of non-infringement of intellectual property rights of any third party.

### **Information**

For further information on technology, delivery terms and conditions and prices, please contact the nearest Infineon Technologies Office ([www.infineon.com](http://www.infineon.com)).

### **Warnings**

Due to technical requirements, components may contain dangerous substances. For information on the types in question, please contact the nearest Infineon Technologies Office.

Infineon Technologies components may be used in life-support devices or systems only with the express written approval of Infineon Technologies, if a failure of such components can reasonably be expected to cause the failure of that life-support device or system or to affect the safety or effectiveness of that device or system. Life support devices or systems are intended to be implanted in the human body or to support and/or maintain and sustain and/or protect human life. If they fail, it is reasonable to assume that the health of the user or other persons may be endangered.