

XS212B4PAL2

inductive sensor XS2 M12 - L37mm - brass - Sn8mm - 12..24VDC - cable 2m



Main

| | |
|------------------------------------|---|
| Range of product | OsiSense XS |
| Series name | General purpose |
| Sensor type | Inductive proximity sensor |
| Device application | Mobile equipment |
| Sensor name | XS2 |
| Sensor design | Cylindrical M12 |
| Size | 37 mm |
| Body type | Fixed |
| Detector flush mounting acceptance | Non flush mountable |
| Material | Metal |
| Type of output signal | Discrete |
| Wiring technique | 3-wire |
| [Sn] nominal sensing distance | 0.31 in (8 mm) |
| Discrete output function | 1 NO |
| Output circuit type | DC |
| Discrete output type | PNP |
| Electrical connection | Cable |
| Cable length | 6.56 ft (2 m) |
| [Us] rated supply voltage | 12...24 V DC reverse polarity protection |
| Switching capacity in mA | <= 200 mA overload and short-circuit protection |
| IP degree of protection | IP65 IEC 60529 IP67 DIN 40050 IP69K |

Complementary

| | |
|--------------------------|-------------------------------|
| Thread type | M12 x 1 |
| Detection face | Frontal |
| Front material | PPS |
| Enclosure material | Nickel Plated Brass |
| Sensing range | > 0.16...0.31 in (> 4...8 mm) |
| Operating zone | 0.00...0.25 in (0...6.4 mm) |
| Differential travel | 1...15% of Sr |
| Cable composition | 3 x 0.34 mm ² |
| Wire insulation material | PvR |
| Status LED | Output state 1 LED yellow) |
| Supply voltage limits | 10...36 V DC |
| Switching frequency | <= 2000 Hz |
| Maximum voltage drop | <2 V closed) |
| Current consumption | <= 10 mA no-load |
| Maximum delay first up | 15 ms |
| Maximum delay response | 0.2 ms |
| Maximum delay recovery | 0.2 ms |
| Marking | CE |
| Threaded length | 0.79 in (20 mm) |

| | |
|------------|------------------------|
| Length | 1.46 in (37 mm) |
| Net Weight | 0.19 lb(US) (0.086 kg) |

Environment

| | |
|---------------------------------------|---|
| Product certifications | CSA E2 UL |
| Ambient air temperature for operation | -13...158 °F (-25...70 °C) |
| Ambient air temperature for storage | -40...185 °F (-40...85 °C) |
| Vibration resistance | 25 gn +/- 2 mm 10...55 Hz)IEC 60068-2-6 |
| Shock resistance | 50 gn 11 ms IEC 60068-2-27 |

Ordering and shipping details

| | |
|-----------------------|----------------------------|
| Category | 22486 - SENSORS, PROXIMITY |
| Discount Schedule | DS2 |
| GTIN | 00785901546283 |
| Nbr. of units in pkg. | 1 |
| Package weight(Lbs) | 0.2 lb(US) (0.09 kg) |
| Returnability | Yes |
| Country of origin | ID |

Packing Units

| | |
|------------------|----------|
| Package 1 Height | 0.420 dm |
| Package 1 width | 0.960 dm |
| Package 1 Length | 1.310 dm |

Offer Sustainability

| | |
|----------------------------|---|
| Sustainable offer status | Green Premium product |
| California proposition 65 | WARNING: This product can expose you to chemicals including: Diisononyl phthalate (DINP), which is known to the State of California to cause cancer, and Di-isodecyl phthalate (DIDP), which is known to the State of California to cause birth defects or other reproductive harm. For more information go to www.P65Warnings.ca.gov |
| REACH Regulation | REACH Declaration |
| EU RoHS Directive | Pro-active compliance (Product out of EU RoHS legal scope) EU RoHS Declaration |
| Mercury free | Yes |
| RoHS exemption information | Yes |
| Environmental Disclosure | Product Environmental Profile |
| Circularity Profile | End Of Life Information |

Dimensions

Pre-cabled

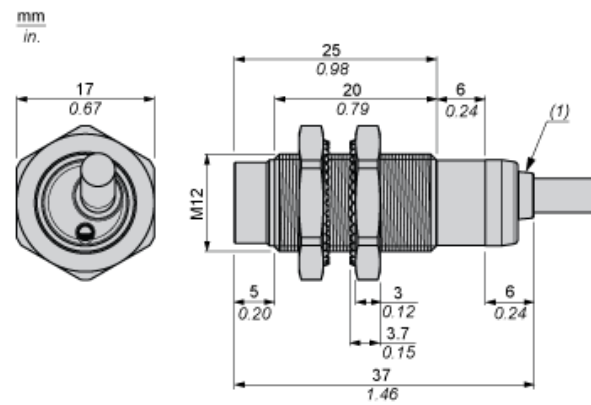

Mounting and Clearance

Minimum Mounting Distances

Side by Side

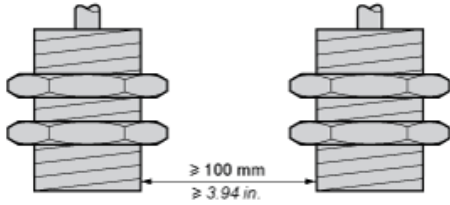

Face to Face

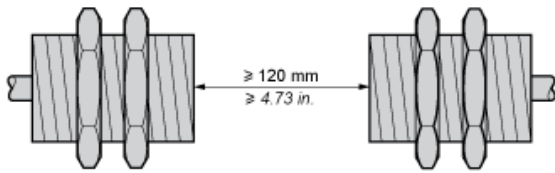

Facing a Metal Object

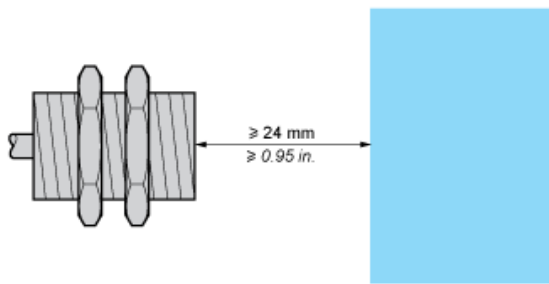

Mounted in a Metal Support

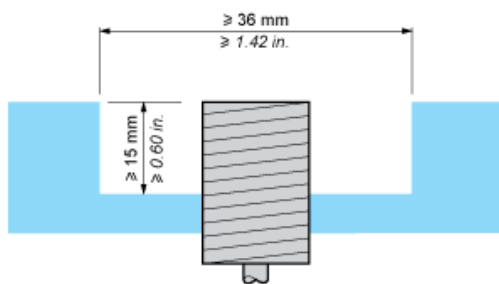

Connection and Schema

Wiring Schemes

PNP 3-wire

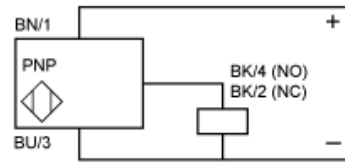

BN : Brown
BK : Black
BU : Blue

Performance Curves

Standard Steel Target: 12 x 12 x 1 mm

Operating zone: 0...6.4 mm

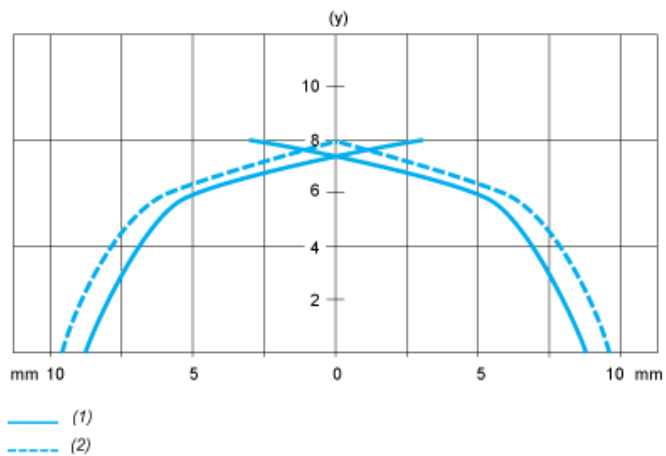

- (y) Sensing distance in mm
- (1) Pick-up points
- (2) Drop-out points (object approaching from the side)