

Miniature Power Relays MY(S)

MY(S) Versatile plug-in Relay







- Reduces wiring work by 60% when combined with the PYF-PU Push-In Plus Socket (according to actual OMRON measurements).
- 10 A (DPDT) and 5 A (4PDT)
- Gold-clad contacts (MY4(S))
- Test button (lockable)
- Wide portfolio includes hermetically sealed and latching types
- 2.6 mm wide pins offer higher conductivity and less temperature increase

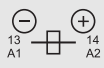

The compliant standards depend on the model.
For details, refer to information provided for individual models.

Refer to the Common Relay Precautions and Safety Precautions on page 32.

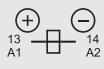
Model Number Structure

Coil Polarity (DC case) *	Type	Contact form	Plug-In socket/solder terminals			Flange mounting	
			With LED indicator	With LED Indicator and Lockable test button	Without LED Indicator		
	Standard model	DPDT	MY2N(S)	MY2IN(S)	MY2(S)	MY2F	
		DPDT (Bifurcated)	MY2ZN	---	---	---	
		4PDT	MY4N(S)	MY4IN(S)	MY4(S)	MY4F	
		4PDT (Bifurcated)	MY4ZN(S)	MY4ZIN(S)	MY4Z(S)	MY4ZF	
	With Built-in diode (DC only)		DPDT	MY2N-D2(S)	MY2IN-D2(S)	---	---
			DPDT (Bifurcated)	MY2ZN-D2	---	---	---
			4PDT	MY4N-D2(S)	MY4IN-D2(S)	---	---
			4PDT (Bifurcated)	MY4ZN-D2(S)	MY4ZIN-D2(S)	---	---
	With Built-in CR (AC only)		DPDT	MY2N-CR(S)	MY2IN-CR(S)	---	---
			4PDT	MY4N-CR(S)	MY4IN-CR(S)	---	---
			4PDT (Bifurcated)	MY4ZN-CR(S)	MY4ZIN-CR(S)	---	---
	High reliability contacts	4PDT (Crossbar Bifurcated)	---	---	MY4Z-CBG	---	
	Plastic Sealed	4PDT	MYQ4N	---	---	---	
		4PDT (Bifurcated)	---	---	MYQ4Z	---	
Latching (coil latching)	DPDT	---	---	MY2K	---		
Hermetic	4PDT	---	---	MY4H	---		
	4PDT (Bifurcated)	---	---	MY4ZH	---		
	Standard model	DPDT	MY2N1(S)	MY2IN1(S)	---	---	
		4PDT	MY4N1(S)	MY4IN1(S)	---	---	
		4PDT (Bifurcated)	MY4ZN1(S)	MY4ZIN1(S)	---	---	
	With Built-in diode (DC only)		DPDT	MY2N1-D2(S)	MY2IN1-D2(S)	---	---
			4PDT	MY4N1-D2(S)	MY4IN1-D2(S)	---	---
			4PDT (Bifurcated)	MY4ZN1-D2(S)	MY4ZIN1-D2(S)	---	---

* In case of AC coil type relay, please select them from "Type 1" of Coil Polarity.

Refer to *Connection Socket and Mounting Bracket Selection Table* on page 24 in *Options* for information on the possible combinations of Models with Plug-in Terminals and Sockets.

MY(S)

Contents

Model Number Structure.....	1
Specifications	
Coil Ratings	2
MY2(S)/MY4(S)/MY4Z(S).....	3
Engineering Data	6
Detailed Information on Models Certified for Safety Standards, MY2(S)/MY4(S)/MY4Z(S).....	8
Models Other Than MY(S) Models	
MY2ZN	9
MY□F.....	11
Detailed Information on Models Certified for Safety Standards, MY2ZN and MY□F.....	14
MY4Z-CBG	15
MYQ4	17
MY2K	19
MY4(Z)H.....	21
Socket for MY.....	23
Options.....	24
Safety Precautions	32

Specifications

Coil Ratings

MY(S)

Rated voltage	Rated current		Coil resistance	Coil inductance (reference value)		Must operate voltage	Must release voltage	Max. voltage	Power consumption (approx.)
	50 Hz	60 Hz		Arm. OFF	Arm. ON				
AC	6 V	214.1 mA	183 mA	12.2 Ω	0.04 H	80% max.	30% min.	110%	Approx. 0.9 to 1.3 VA (60 Hz)
	12 V	106.5 mA	91 mA	46 Ω	0.17 H				
	24 V	53.8 mA	46 mA	180 Ω	0.69 H				
	48/50 V	24.7/25.7 mA	21.1/22.0 mA	788 Ω	3.22 H				
	110/120 V	9.9/10.8 mA	8.4/9.2 mA	4,430 Ω	19.20 H				
	220/240 V	4.8/5.3 mA	4.2/4.6 mA	18,790 Ω	83.50 H				
DC	6 V	151 mA		39.8 Ω	0.17 H	10% min.			0.9 W
	12 V	75 mA		160 Ω	0.73 H				
	24 V	37.7 mA		636 Ω	3.20 H				
	48 V	18.8 mA		2,560 Ω	10.60 H				
	100/110 V	9.0/9.9 mA		11,100 Ω	45.60 H				

- Note:** 1. The rated current and coil resistance are measured at a coil temperature of 23°C with tolerances of +15%/-20% for rated currents and ±15% for DC coil resistance.
2. Performance characteristic data are measured at a coil temperature of 23°C.
3. AC coil resistance and impedance are provided as reference values (at 60 Hz).
4. Power consumption drop was measured for the above data. When driving transistors, check leakage current and connect a bleeder resistor if required.

MY2ZN, MY□F, MY4(Z)H

Rated voltage (V)	Item	Rated current (mA)		Coil resistance (Ω)	Coil inductance (H)		Must-operate voltage (V)	Must-release voltage (V)	Maximum voltage (V)	Power consumption (VA, W)
		50 Hz	60 Hz		Armature OFF	Armature ON				
AC	12	106.5	91	46	0.17	0.33	80% max.*1	30% min.*2	110% of rated voltage	Approx. 0.9 to 1.3 VA (60 Hz)
	24	53.8	46	180	0.69	1.3				
	100/110	11.7/12.9	10/11	3,750	14.54	24.6				
	110/120	9.9/10.8	8.4/9.2	4,430	19.2	32.1				
	200/220	6.2/6.8	5.3/5.8	12,950	54.75	94.07				
	220/240	4.8/5.3	4.2/4.6	18,790	83.5	136.4				
DC	12	75		160	0.73	1.37	10% min.*2			Approx. 0.9
	24	36.9		650	3.2	5.72				
	48	18.5		2,600	10.6	21.0				
	100/110	9.1/10		11,000	45.6	86.2				

- Note:** 1. The rated current and coil resistance are measured at a coil temperature of 23°C with tolerances of +15%/-20% for the AC rated current and ±15% for the DC coil resistance.
2. The AC coil resistance and inductance values are reference values only (at 60 Hz).
3. Operating characteristics were measured at a coil temperature of 23°C.
4. The maximum voltage capacity was measured at an ambient temperature of 23°C.

*1. There is variation between products, but actual values are 80% max.
To ensure operation, apply at least 80% of the rated value

*2. There is variation between products, but actual values are 30% minimum for AC and 10% minimum for DC. To ensure release, use a value that is lower than the specified value.

Note: Refer to page 19 for the coil specifications of the MY2K.

Miniature Power Relays: MY2(S)/MY4(S)/MY4Z(S)



Refer to the standards certifications and compliance section of your OMRON website for the latest information on certified models.

Specifications

Contact Ratings

Item	DPDT		4PDT		4PDT (bifurcated)	
	Resistive load (cos φ = 1)	Inductive load (cos φ = 0.4, L/R = 7 ms)	Resistive load (cos φ = 1)	Inductive load (cos φ = 0.4, L/R = 7 ms)	Resistive load (cos φ = 1)	Inductive load (cos φ = 0.4, L/R = 7 ms)
Rated load	5A, 250 VAC 5A, 30 VDC	2A, 250 VAC 2 A, 30 VDC	3 A, 250 VAC 3 A, 30 VDC	0.8 A, 250 VAC 1.5 A, 30 VDC	3 A, 250 VAC 3 A, 30 VDC	0.8 A, 250 VAC 1.5 A, 30 VDC
Carry current	10 A (see note)		5 A (see note)			
Max. switching voltage	250 VAC 125 VDC					
Max. switching current	10 A		5 A			
Contact materials	Ag		Au cladding + Ag alloy			
Failure rate (reference value)	5 VDC, 1 mA		1 VDC, 1 mA		1 VDC, 100 μA	

Note: Don't exceed the carry current of a Socket in use. Please see page 23.

Characteristics

Item	All Relays
Contact resistance	100 mΩ max. (50 mΩ: 4PDT bifurcated)
Operate time	20 ms max.
Release time	20 ms max.
Max. operating frequency	Mechanical:18,000 operations/hr Electrical:1,800 operations/hr (under rated load)
Insulation resistance	100 MΩ min. (at 500 VDC)
Dielectric strength	2,000 VAC, 50/60 Hz for 1.0 min (1,000 VAC between contacts of same polarity)
Vibration resistance	Destruction:10 to 55 to 10 Hz, 0.5 mm single amplitude (1.0 mm double amplitude) Malfunction:10 to 55 to 10 Hz, 0.5 mm single amplitude (1.0 mm double amplitude)
Shock resistance	Destruction:1,000 m/s ² Malfunction:200 m/s ²
Endurance	See the following table.
Ambient temperature	Operating: -55 to 70°C (with no icing)
Ambient humidity	Operating: 5 to 85% RH
Weight	Approx. 35 g

Note: The values given above are initial values.

Endurance Characteristics

Contact form	Mechanical life (at 18,000 operations/hr)	Electrical life (at 1,800 operations/hr under rated load)
DPDT	AC:50,000,000 operations min. DC:100,000,000 operations min.	500,000 operations min.
4PDT		200,000 operations min.
4PDT (bifurcated)	20,000,000 operations min.	100,000 operations min.

MY(S)

Dimensions

(Unit: mm)

List of Models

MY2□□(S) Series

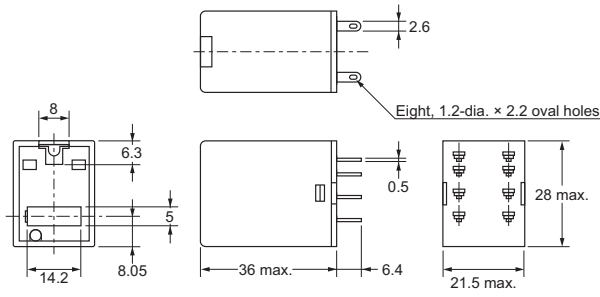

Note: The picture is lockable test button type.

Terminal Arrangement/Internal Connections (Bottom View)

MY2IN(S)
(AC Model)

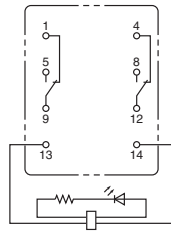

MY2IN(S)
(DC Models)

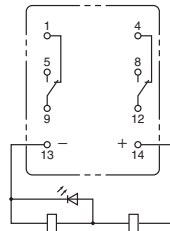

MY2IN-D2(S)
(DC Models Only)

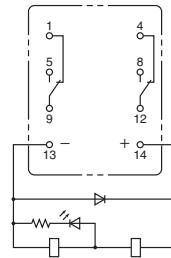

MY2IN-CR
(AC Models Only)

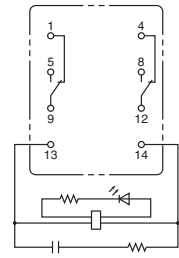

MY2IN1(S)
(DC Models)

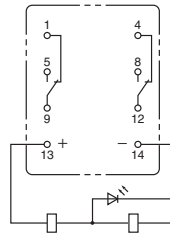

MY2IN1-D2(S)
(DC Models Only)

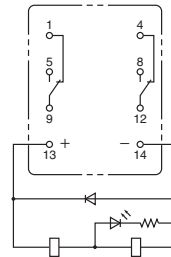

Note: For the DC models, check the coil polarity when wiring and wire all connections correctly.

MY4□□(S) series

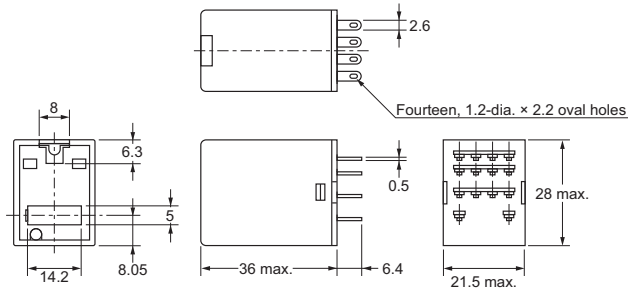

Note: The picture is lockable test button type.

Terminal Arrangement/Internal Connections (Bottom View)

MY4(Z)IN(S)
(DC Models)

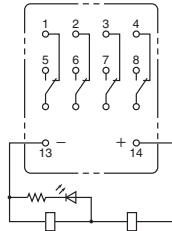

MY4(Z)IN(S)
(AC Models)

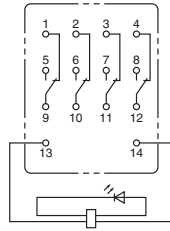

MY4(Z)IN-D2(S)
(DC Models Only)

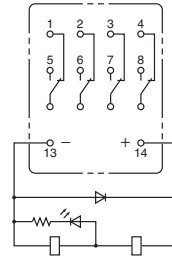

MY4(Z)IN-CR(S)
(AC Models Only)

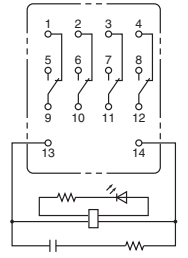

MY4(Z)IN1(S)
(DC Models)

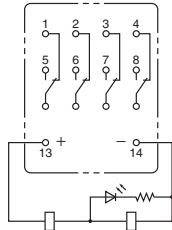

MY4(Z)IN1-D2(S)
(DC Models Only)

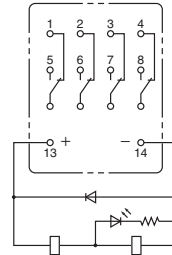

Note: For the DC models, check the coil polarity when wiring and wire all connections correctly.

MY(S)

Engineering Data MY2(S)/ MY4(S)/MY4Z(S)

Maximum Switching Capacity MY2(S)

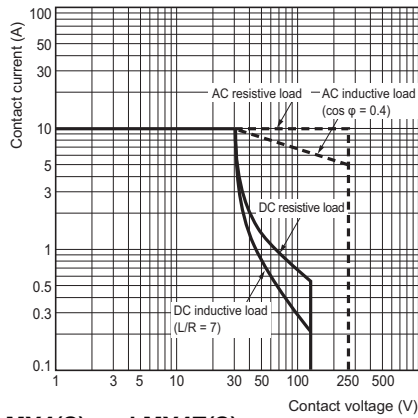

MY4(S) and MY4Z(S)

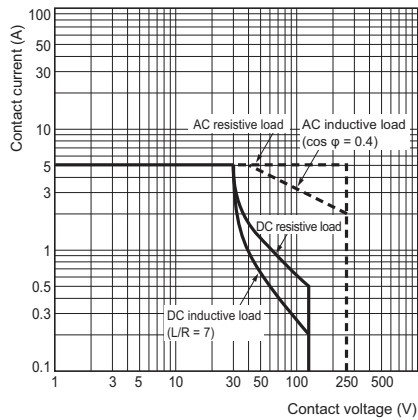

Endurance Curve MY2(S)

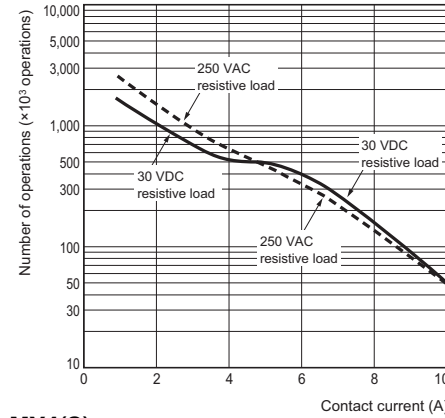

MY2(S)

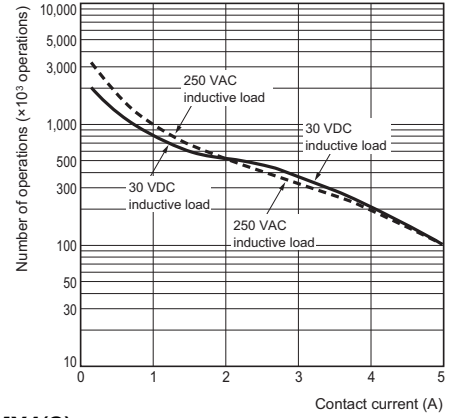

MY4(S)

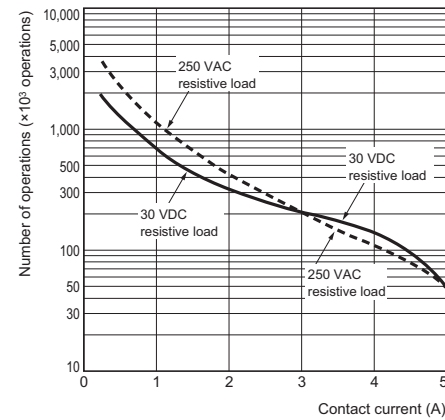

MY4(S)

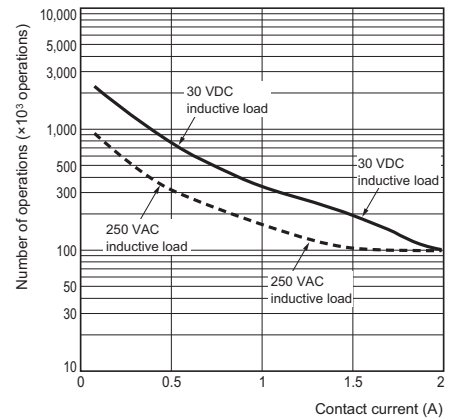

MY4Z(S)

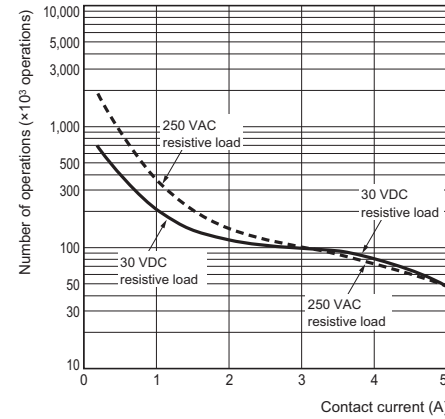

MY4Z(S)

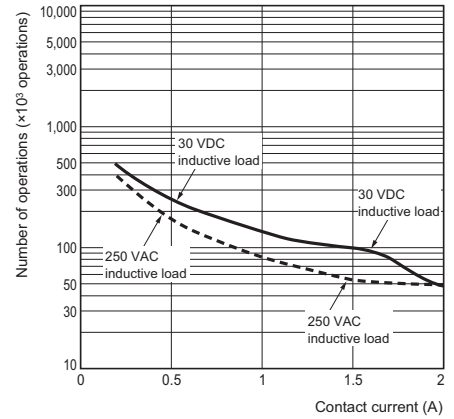

Common Specifications for MY2(S)/MY4(S)/MY4Z(S) Malfunctioning Shock

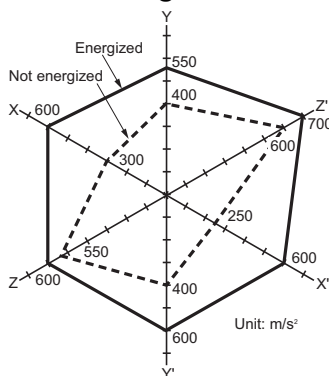

N = 20

Measurement: Shock was applied 3 times each in 6 directions along 3 axes with the Relay energized and not energized to check the shock values that cause the Relay to malfunction.

Criteria: Non-energized: 200 m/s²,

Energized: 200 m/s²

Shock direction

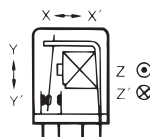

Engineering Data MY(S) (MY2ZN, MY□F)

Ambient Temperature vs. Must-operate and Must-release Voltage MY2 AC Models

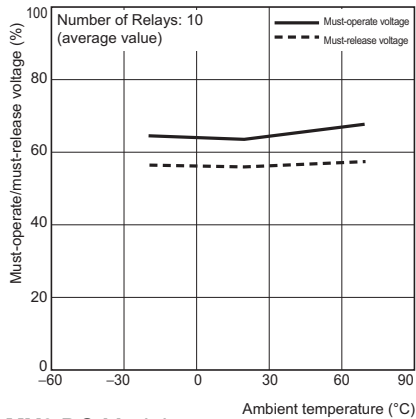

MY2 DC Models

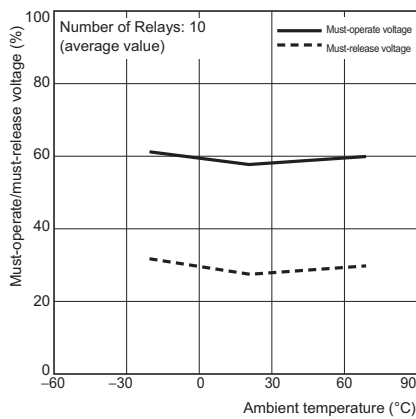

MY4 AC Models

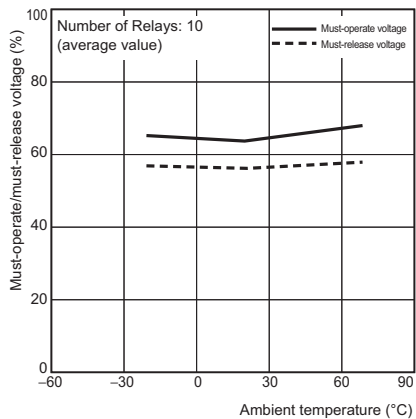

MY4 DC Models

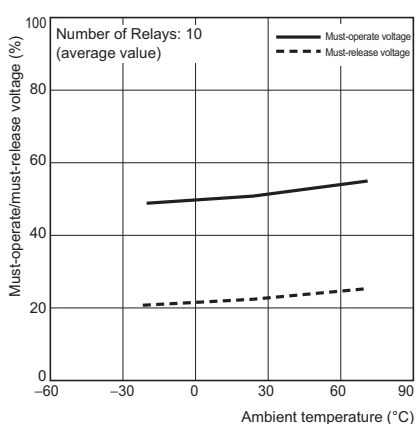

Ambient Temperature vs. Coil Temperature Rise

MY2 AC Models, 50 Hz

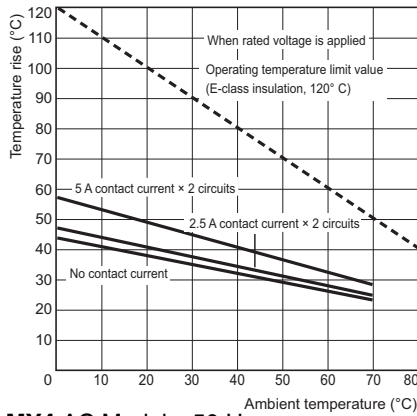

MY2 DC Models

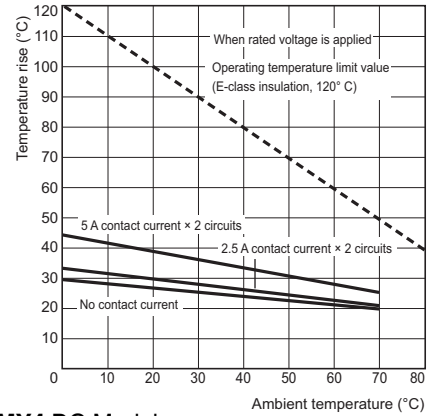

MY4 AC Models, 50 Hz

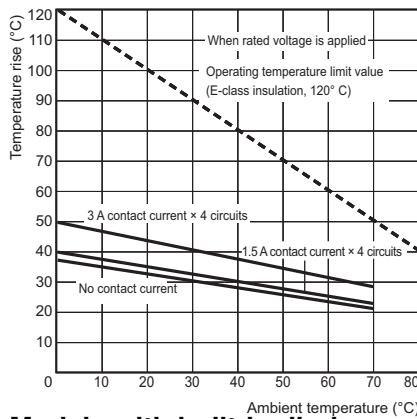

MY4 DC Models

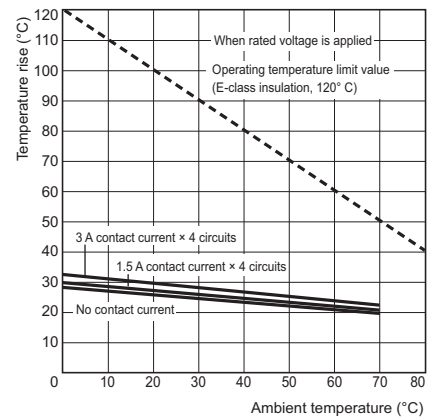

Models with built-in diodes

The diode absorbs surge from the coil. This type is best suited for applications with semiconductor circuits.

With Diode

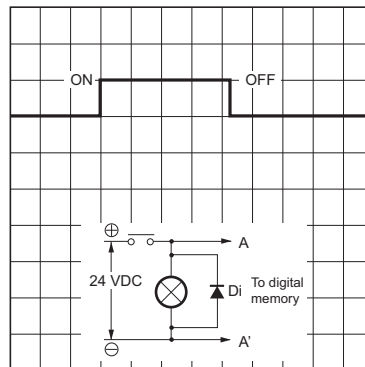

Without Diode

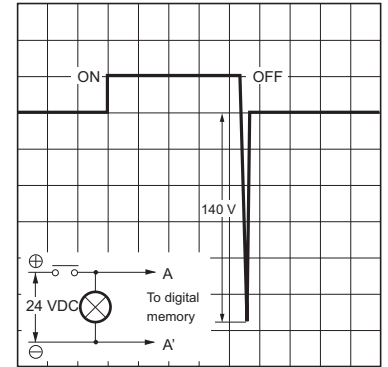

- Note:**
1. Make sure that the polarity is correct.
 2. The release time will increase, but the 20-ms specification for standard models is satisfied.
 3. Diode properties: The diode has a reversed dielectric strength of 1,000 V. Forward current: 1 A

Models with Built-in CR Circuits

With CR

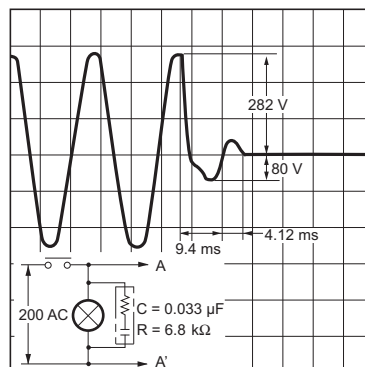

Without CR

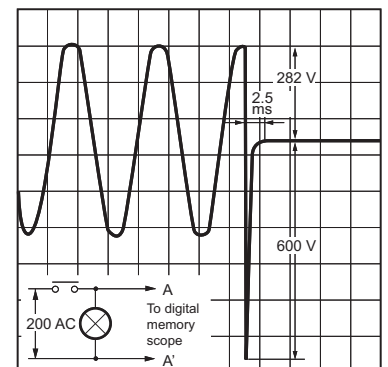

MY(S)

Detailed Information on Models Certified for Safety Standards, MY2(S)/MY4(S)/MY4Z(S)

VDE-certified Models (No. 112467UG, EN61810-1)

Model	Coil ratings	Contact form	Contact ratings	File No.	Certified number of operations
MY□	6, 12, 24, 48/50, 100/ 110, 110/120, 200/ 220, and 220/240 VAC 6, 12, 24, 48, 100/ 110, and 125 VDC	DPDT	10 A, 250 VAC (cos φ = 1) 10 A, 30 VDC (L/R = 0 ms)	6692 (VDE0435)	MY2: 10,000 operations MY4: 100,000 operations MY4Z: 50,000 operations (AC)
		4PDT	5 A, 250 VAC (cos φ = 1) 5 A, 30 VDC (L/R = 0 ms)		

UL508-certified Models (File No. 41515)

Model	Coil ratings	Contact form	Contact ratings	File No.	Certified number of operations
MY□	6 to 240 VAC 6 to 125 VDC	DPDT	10A, 250 VAC (General Use)	E41515 (UL508)	6,000
			10A, 30 VDC (General Use)		
			7A, 240 VAC (General Use)		
			7A, 24 VDC (Resistive)		
			5A, 240 VAC (General Use)		
			5A, 250 VAC (Resistive)		
			5A, 30 VDC (Resistive)		
			3A, 265 VAC (Resistive)		
			1/6HP, 250 VAC		
			1/8HP, 265 VAC		
			1/10HP, 120 VAC		
			B300 Pilot Duty (Same polarity)		
		4PDT	5A, 28 VDC (General Use) (Same polarity)		6,000
			5A, 240 VAC (General Use) (Same polarity)		
			5A, 30 VDC (Resistive) (Same polarity)		
			5A, 250 VAC (Resistive) (Same polarity)		
			0.2A, 120 VDC (Resistive) (Same polarity)		
			1/6HP, 250 VAC (Same polarity)		
			1/10HP, 120 VAC (Same polarity)		
			B300 Pilot Duty (Same polarity)		
		1,000			
		6,000			

CSA 22.2 No. 14-certified Models (File No. LR31928)

Model	Coil ratings	Contact form	Contact ratings	File No.	Certified number of operations		
MY□	6 to 240 VAC 6 to 125 VDC	DPDT	7A, 240 VAC (General Use)	LR31928 (CSA C22.2) (No. 14)	6,000		
			7A, 24 VDC (Resistive)				
			5A, 240 VAC (General Use)				
			5A, 250 VAC (Resistive)				
			5A, 30 VDC (Resistive)				
			3A, 265 VAC (Resistive)				
			1/6HP, 250 VAC				
			1/8HP, 265 VAC				
			1/10HP, 120 VAC				
			B300 Pilot Duty (Same polarity)				
			4PDT			5A, 240 VAC (General Use) (Same polarity)	6,000
						5A, 28 VDC (General Use) (Same polarity)	
		5A, 250 VAC (Resistive) (Same polarity)					
		5A, 30 VDC (Resistive) (Same polarity)					
		0.2A, 120 VDC (Resistive) (Same polarity)					
		1/6HP, 250 VAC (Same polarity)					
		1/10HP, 120 VAC (Same polarity)					
		B300 Pilot Duty (Same polarity)					
					1,000		
					6,000		

LR-certified Models (File No. 98/10014)

Model	Coil ratings	Contact form	Contact ratings	File No.	Certified number of operations
MY□	6 to 240 VAC 6 to 125 VDC	DPDT	10 A, 250 VAC (resistive) 2 A, 250 VAC (PF0.4) 10 A, 30 VDC (resistive) 2 A, 30 VDC (L/R = 7 ms)	98/10014	MY2: 50,000 operations MY4: 50,000 operations
		4PDT	5 A, 250 VAC (resistive) 0.8 A, 250 VAC (PF0.4) 5 A, 30 VDC (resistive) 1.5 A, 30 VDC (L/R = 7 ms)		

Miniature Power Relays: MY2ZN



Refer to the standards certifications and compliance section of your OMRON website for the latest information on certified models.

Specifications

Contact Ratings

Item	Load	Resistive load	Inductive load ($\cos \phi = 0.4$, $L/R = 7$ ms)
Rated load		5 A at 220 VAC 5 A at 24 VDC	2 A at 220 VAC 2 A at 24 VDC
Rated carry current		5 A	
Maximum contact voltage		250 VAC, 125 VDC	
Maximum contact current		5 A	
Contact form		DPDT (Bifurcated)	
Contact materials		Au plating + Ag	

Item	Type	Standard models	Model with built-in operation indicator, diode, or CR circuit
Ambient operating temperature*1		-55 to 70° C	-55 to 60° C*2
Ambient operating humidity		5% to 85%	

*1. With no icing or condensation.
*2. This limitation is due to the diode junction temperature and elements used.

Characteristics

Item	MY2ZN series	
Contact resistance*1	50 mΩ max.	
Operation time*2	20 ms max.	
Release time*2	20 ms max.	
Maximum operating frequency	Mechanical	18,000 operations/h
	Rated load	1,800 operations/h
Insulation resistance*3	100 MΩ min.	
Dielectric strength	Between coil and contacts	
	Between contacts of different polarity	2,000 VAC at 50/60 Hz for 1 min.
	Between contacts of the same polarity	1,000 VAC at 50/60 Hz for 1 min.
Vibration resistance	Destruction	10 to 55 to 10 Hz, 0.5-mm single amplitude (1.0-mm double amplitude)
	Malfunfunction	10 to 55 to 10 Hz, 0.5-mm single amplitude (1.0-mm double amplitude)
Shock resistance	Destruction	1,000 m/s ²
	Malfunfunction	200 m/s ²
Endurance	Mechanical	50,000,000 operations min. (operating frequency: 18,000 operations/h)
	Electrical*4	200,000 operations min. (rated load, switching frequency: 1,800 operations/h)

Item	MY2ZN
Failure rate P value (reference value)*5	100 μA at 1 VDC
Weight	Approx. 35 g

Note: These are initial values.

- *1. Measurement conditions: 1 A at 5 VDC using the voltage drop method.
- *2. Measurement conditions: With rated operating power applied.
Ambient temperature condition: 23° C
- *3. Measurement conditions: For 500 VDC applied to the same location as for dielectric strength measurement.
- *4. Ambient temperature condition: 23° C
- *5. This value was measured at a switching frequency of 120 operations per minute.

MY(S)

Dimensions

(Unit: mm)

MY2ZN, MY2ZN-D2

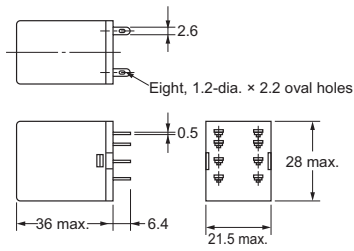
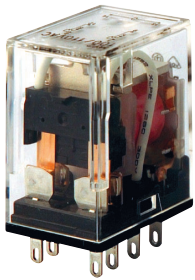

* For the MY2Z-CR and MY2ZN-CR, this dimension is 53 mm max.

MY2ZN
(AC Models)

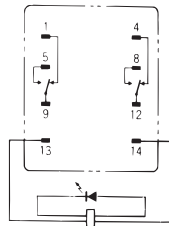

(The coil has no polarity.)

MY2ZN
(DC Models)

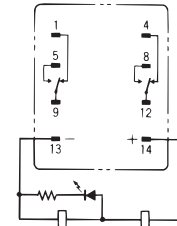

(Check the coil polarity when wiring and wire all connections correctly.)

MY2ZN-D2
(DC Models Only)

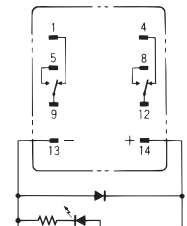

(Check the coil polarity when wiring and wire all connections correctly.)

- Note:**
1. An AC model has coil disconnection self-diagnosis.
 2. For the DC models, check the coil polarity when wiring and wire all connections correctly.
 3. The indicator is red for AC and green for DC.
 4. The operation indicator indicates the energization of the coil and does not represent contact operation.

Flange-mounting Relays: MY□F



Refer to the standards certifications and compliance section of your OMRON website for the latest information on certified models.

Specifications

Contact Ratings

Item	Contact form Load	DPDT		4PDT, 4PDT (Bifurcated)	
		Resistive load	Inductive load (cos φ = 0.4, L/R = 7 ms)	Resistive load	Inductive load (cos φ = 0.4, L/R = 7 ms)
Rated load	5 A at 220 VAC 5 A at 24 VDC	2 A at 220 VAC 2 A at 24 VDC	3 A at 220 VAC 3 A at 24 VDC	0.8 A at 220 VAC 1.5 A at 24 VDC	
Rated carry current	5 A		3 A		
Maximum contact voltage	250 VAC, 125 VDC				
Maximum contact current	5 A		3 A		
Contact form	DPDT		4PDT, 4PDT (Bifurcated)		
Contact materials	Ag		Au plating + Ag		

Item	Type	MY□F
Ambient operating temperature*		-55 to 70° C
Ambient operating humidity		5% to 85%

* With no icing or condensation.

Characteristics

Item	Contact form	DPDT	4PDT, 4PDT (Bifurcated)
Contact resistance*1		50 mΩ max.	
Operation time*2		20 ms max.	
Release time*2		20 ms max.	
Maximum operating frequency	Mechanical	18,000 operations/h	
	Rated load	1,800 operations/h	
Insulation resistance*3		100 MΩ min.	
Dielectric strength	Between coil and contacts		
	Between contacts of different polarity	2,000 VAC at 50/60 Hz for 1 min.	
	Between contacts of the same polarity	1,000 VAC at 50/60 Hz for 1 min.	
Vibration resistance	Destruction	10 to 55 to 10 Hz, 0.5-mm single amplitude (1.0-mm double amplitude)	
	Malfunction	10 to 55 to 10 Hz, 0.5-mm single amplitude (1.0-mm double amplitude)	
Shock resistance	Destruction	1,000 m/s ²	
	Malfunction	200 m/s ²	
Endurance	Mechanical	AC: 50,000,000 operations min. DC: 100,000,000 operations min. (switching frequency: 18,000 operations/h)	
	Electrical*4	500,000 operations min. (rated load, switching frequency: 1,800 operations/h)	200,000 operations min. (rated load, switching frequency: 1,800 operations/h)

Item	Contact form	DPDT	4PDT, 4PDT (Bifurcated)
Failure rate P value (reference value)		1 mA at 5 VDC	1 mA at 1 VDC
Weight		Approx. 35 g	

Note: These are initial values.

*1. Measurement conditions: 1 A at 5 VDC using the voltage drop method

*2. Measurement conditions: With rated operating power applied. Ambient temperature condition: 23° C

*3. Measurement conditions: For 500 VDC applied to the same location as for dielectric strength measurement.

*4. Ambient temperature condition: 23° C

*5. This value was measured at a switching frequency of 120 operations per minute.

MY(S)

Dimensions

(Unit: mm)

Flange mounting MY□F



The above figure is for the MY4F.

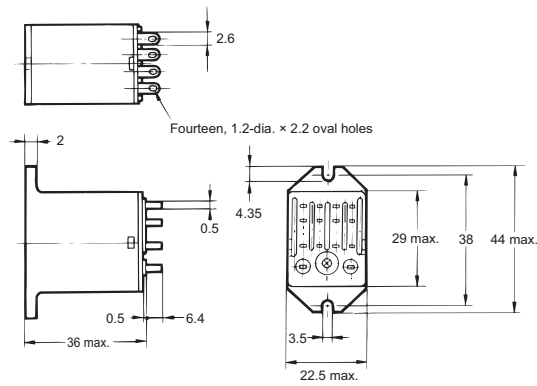

Mounting Hole Dimensions

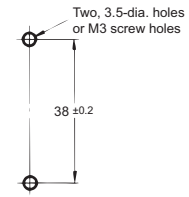

Note: Refer to the terminal arrangement and internal connections diagrams for the MY2(S), MY4(S) and MY4Z(S).

Engineering Data MY□F

Maximum Switching Capacity MY2F

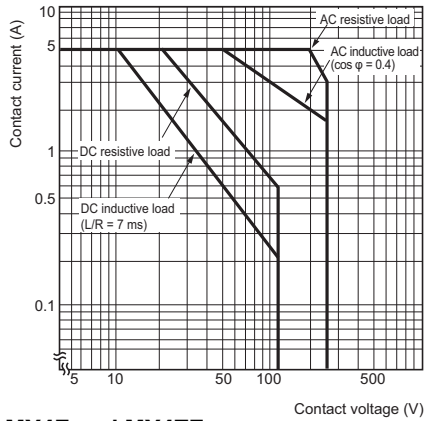

MY4F and MY4ZF

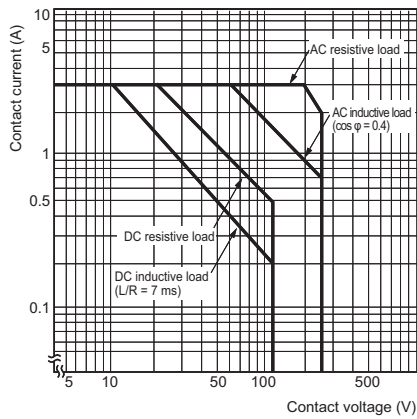

Endurance Curve MY2F

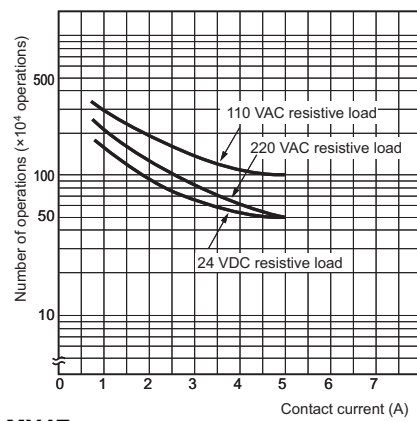

MY4F

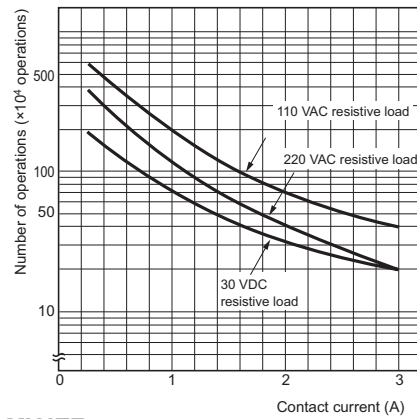

MY4ZF

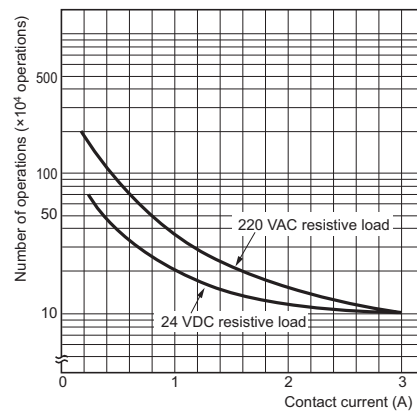

MY2F

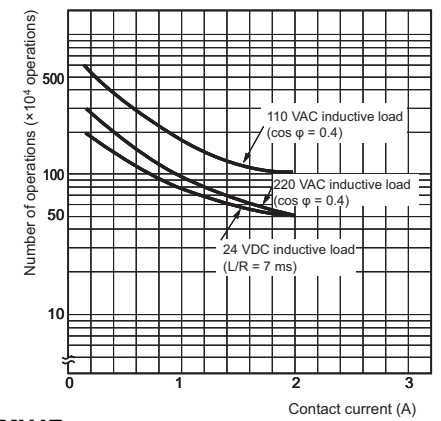

MY4F

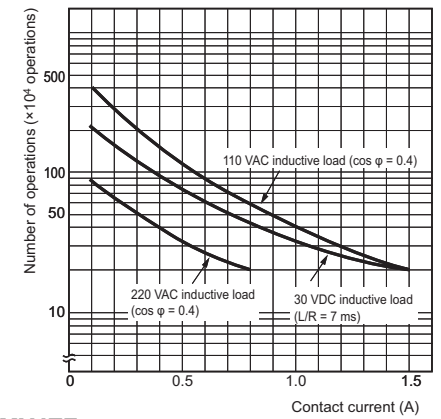

MY4ZF

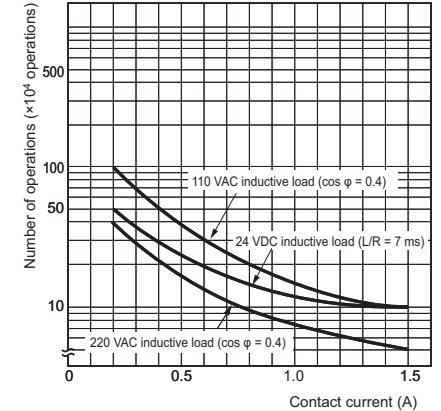

Common Specifications for MY□F Malfunctioning Shock

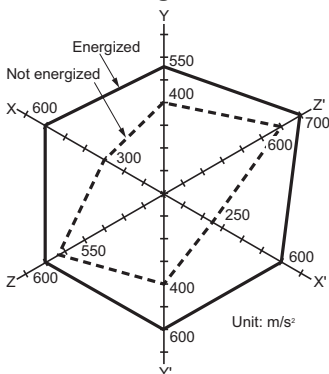

N = 20

Measurement: Shock was applied 3 times each in 6 directions along 3 axes with the Relay energized and not energized to check the shock values that cause the Relay to malfunction.

Criteria: Non-energized: 200 m/s²,

Energized: 200 m/s²

Shock direction

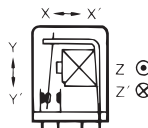

MY(S)

Detailed Information on Models Certified for Safety Standards, MY2ZN and MY□F

- The standard models are certified for UL and CSA standards.
- The rated values for safety standard certification are not the same as individually defined performance values. Always check the specifications before use.

TÜV-certified Models (File No. R50030059)

Model	Coil ratings	Contact form	Contact ratings	Certified number of operations
MY□	6 to 125 VDC 6 to 240 VDC	DPDT	5 A, 250 VAC (cos φ = 1.0)	10,000 operations
		4PDT	3 A, 120 VAC (cos φ = 1.0) 0.8 A, 120 VAC (cos φ = 0.4)	

UL-certified Models (File No. E41515)

Model	Coil ratings	Contact form	Contact ratings	Certified number of operations
MY□	6 to 240 VAC 6 to 125 VDC	DPDT	7A, 240 VAC (General Use)	6,000
			7A, 24 VDC (Resistive)	
			5A, 240 VAC (General Use)	
			5A, 250 VAC (Resistive)	
			5A, 30 VDC (Resistive)	
			3A, 265 VAC (Resistive)	
			1/6HP, 250 VAC	
		1/8HP, 265 VAC		
		1/10HP, 120 VAC		
		B300 Pilot Duty	6,000	
		4PDT	5A, 28 VDC (General Use) (Same polarity)	6,000
			5A, 240 VAC (General Use) (Same polarity)	
			5A, 30 VDC (Resistive) (Same polarity)	
			5A, 250 VAC (Resistive) (Same polarity)	
0.2A, 120 VDC (Resistive) (Same polarity)				
1/6HP, 250 VAC (Same polarity)	1,000			
1/10HP, 120 VAC (Same polarity)				
B300 Pilot Duty (Same polarity)	6,000			

CSA-certified Models (File No. LR31928)

Model	Coil ratings	Contact form	Contact ratings	Certified number of operations	
MY□	6 to 240 VAC 6 to 125 VDC	DPDT	7A, 240 VAC (Resistive)	6,000	
			7A, 24 VDC (Resistive)		
			5A, 240 VAC (General Use)		
			5A, 250 VAC (Resistive)		
			5A, 30 VDC (Resistive)		
			1/6HP, 250 VAC		1,000
		1/10HP, 120 VAC			
		4PDT	7A, 240 VAC (General Use) (Same polarity)	6,000	
			7A, 24 VDC (Resistive) (Same polarity)		
			5A, 240 VAC (General Use) (Same polarity)		
			5A, 30 VDC (Resistive)		
			5A, 250 VAC (Resistive) (Same polarity)		
			0.2A, 120 VDC (Resistive)		1,000
			1/6HP, 250 VAC		
1/10HP, 120 VAC					

- When ordering models that are certified for Lloyd's Register (LR) Standards, be sure to specify "LR-certified Model" with your order.

LR-certified Models (File No. 90/10270)

Model	Coil ratings	Contact form	Contact ratings
MY□	6 to 240 VAC 6 to 125 VDC	DPDT	2 A, 30 VDC inductive load 2 A, 200 VAC inductive load
		4PDT	1.5 A, 30 VDC inductive load 0.8 A, 200 VAC inductive load 1.5 A, 115 VAC inductive load

Miniature Power Relays: MY4Z-CBG

Specifications

Contact Ratings

Item	Load	Resistive load	Inductive load ($\cos \varphi = 0.4, L/R = 7 \text{ ms}$)
Rated load		1 A at 220 VAC 1 A at 24 VDC	0.3 A at 220 VAC 0.5 A at 24 VDC
Rated carry current		1 A	
Maximum contact voltage		250 VAC, 125 VDC	
Maximum contact current		1 A	
Contact form		4PDT (Crossbar bifurcated)	
Contact materials		Au cladding + AgPd	

Characteristics

Contact resistance*1		100 mΩ max.
Operation time*2		20 ms max.
Release time*2		20 ms max.
Maximum operating frequency	Mechanical	18,000 operations/h
	Electrical	1,800 operations/h
Insulation resistance*3		100 MΩ
Dielectric strength	Between coil and contacts	2,000 VAC at 50/60 Hz for 1 min.
	Between contacts of different polarity	
	Between contacts of the same polarity	700 VAC at 50/60 Hz for 1 min.
Vibration resistance	Destruction	10 to 55 to 10 Hz, 0.5-mm single amplitude (1.0-mm double amplitude)
	Malfunction	10 to 55 to 10 Hz, 0.5-mm single amplitude (1.0-mm double amplitude)
Shock resistance	Destruction	1,000 m/s ²
	Malfunction	200 m/s ²
Endurance	Mechanical	5,000,000 operations min. (operating frequency: 18,000 operations/hr)
	Electrical*4	50,000 operations min. (switching frequency: 1,800 operations/h) at rated load
Failure rate P value (reference value)*5		100 μA at 1 VDC
Ambient operating temperature		-25 to 70°C (with no icing or condensation)
Ambient operating humidity		5% to 85%
Weight		Approx. 35 g

Note: The above values are initial values.

*1. Measurement conditions: 1 A at 5 VDC using the voltage drop method
 *2. Measurement conditions: With rated operating power applied, not including contact bounce.
 Ambient temperature condition: 23° C

*3. Measurement conditions: For 500 VDC applied to the same location as for dielectric strength measurement.

*4. Ambient temperature condition: 23° C

*5. This value was measured at a switching frequency of 120 operations per minute.

Engineering Data

Maximum Switching Capacity

MY4Z-CBG

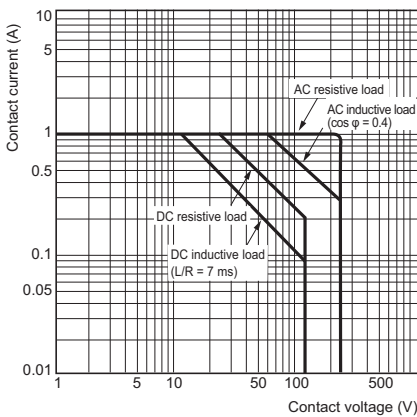

Contact Reliability Test (Modified Allen Bradley Circuit)

Contact load: 5 VDC, 1 mA resistive load
 Malfunction criteria level: Contact resistance of 100 Ω

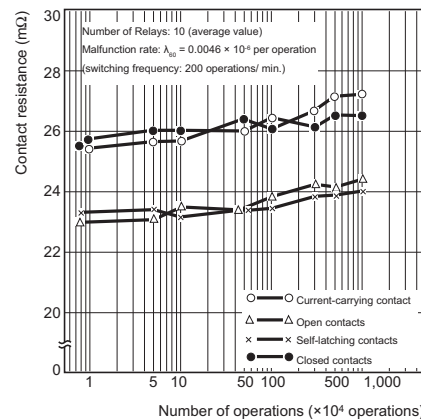

MY(S)

Dimensions

(Unit: mm)

MY4Z-CBG

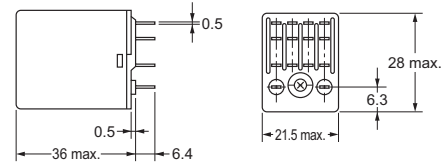
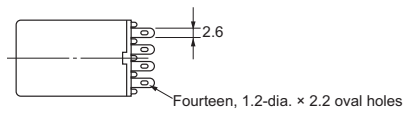

Terminal Arrangement/Internal Connections (Bottom View) Standard Models

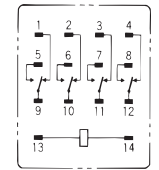

(The coil has no polarity.)

Safety Precautions

Refer to the *Common Relay Precautions*.

Applicable Sockets

Use only combinations of OMRON Relays and Sockets.

Plastic Sealed Relays: MYQ4

Specifications

Contact Ratings

Item	Type	Resistive load	Inductive load ($\cos \phi = 0.4, L/R = 7 \text{ ms}$)
Rated load		1 A at 220 VAC, 1 A at 24 VDC	0.5 A at 220 VAC, 0.5 A at 24 VDC
Rated carry current		1 A	
Maximum contact voltage		250 VAC, 125 VDC	
Maximum contact current		1 A	
Maximum switching capacity (reference value)		220 VAC, 24 W	110 VAC, 12 W
Failure rate P value (reference value)		Single contacts: 1 mA at 1 VDC, Bifurcated contacts: 100 μA at 1 VDC	
Contact form		4PDT, 4PDT (Bifurcated)	
Contact materials		Au plating + Ag	

* This value was measured at a switching frequency of 120 operations per minute.

Ambient operating temperature	-55 to 60° C*
Ambient operating humidity	5% to 85%

* With no icing or condensation.

Characteristics

Contact resistance*1		50 m Ω max.
Operation time*2		20 ms max.
Release time*2		20 ms max.
Maximum operating frequency	Mechanical	18,000 operations/h
	Rated load	1,800 operations/h
Dielectric strength	Between coil and contacts	1,500 VAC at 50/60 Hz for 1 min.
	Between contacts of different polarity	1,500 VAC at 50/60 Hz for 1 min.
	Between contacts of the same polarity	1,000 VAC at 50/60 Hz for 1 min.
Insulation resistance*3		100 M Ω min.
Vibration resistance	Destruction	10 to 55 to 10 Hz, 0.5-mm single amplitude (1.0-mm double amplitude)
	Malfunction	10 to 55 to 10 Hz, 0.5-mm single amplitude (1.0-mm double amplitude)
Shock resistance	Destruction	1,000 m/s ²
	Malfunction	200 m/s ²
Endurance	Mechanical	AC: 50,000,000 operations (5,000,000*4) min., DC: 100,000,000 operations (5,000,000*4) min. (switching frequency: 18,000 operations/h)
	Electrical*5	200,000 operations min. (100,000 operations*4) (rated load, switching frequency: 1,800 operations/h)
Weight		Approx. 35 g

Note: The values at the left are initial values.

*1. Measurement conditions: 1 A at 5 VDC using the voltage drop method

*2. Measurement conditions: With rated operating power applied, not including contact bounce. Ambient temperature condition: 23° C

*3. Measurement conditions: For 500 VDC applied to the same location as for dielectric strength measurement.

*4. This value is for bifurcated contacts.

*5. Ambient temperature condition: 23° C

Engineering Data

Maximum Switching Capacity MYQ4(Z)

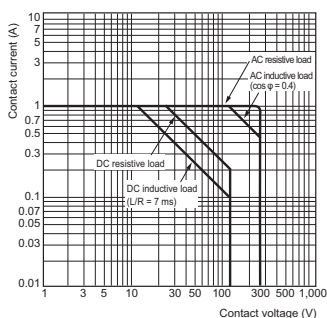

Endurance Curve MYQ4

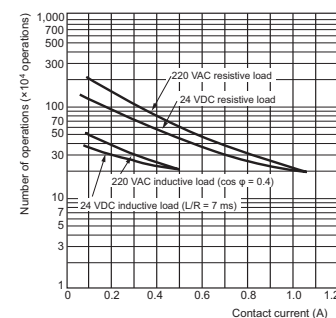

Note: The durability of bifurcated contacts is one-half that of single contacts.

H₂S Gas Data MYQ4

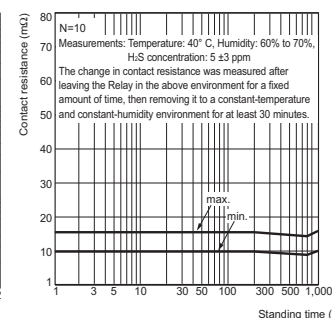

Malfunctioning Shock

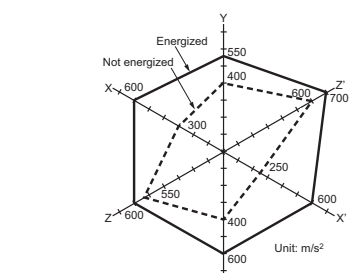

N = 20
Measurement: Shock was applied 3 times each in 6 directions along 3 axes with the Relay energized and not energized to check the shock values that cause the Relay to malfunction.
Criteria: Non-energized: 200 m/s²
Energized: 200 m/s²



MY(S)

Dimensions

(Unit: mm)

Relays with Plug-in Terminals or Soldered Terminals MYQ4(Z)(N)

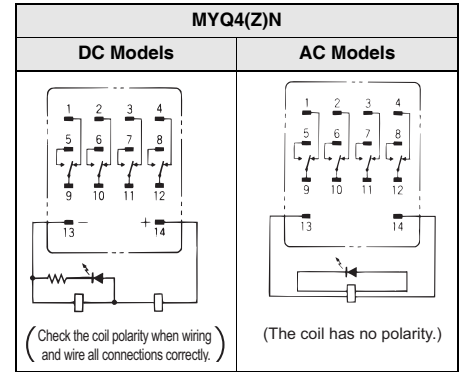
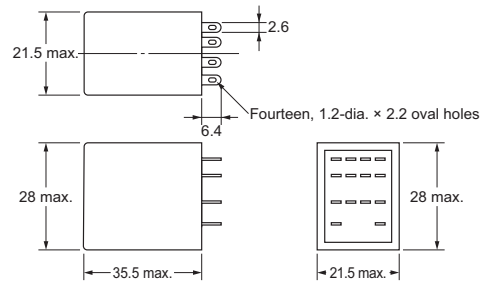

- Note:**
1. An AC model has coil disconnection self-diagnosis.
 2. For the DC models, check the coil polarity when wiring and wire all connections correctly.

Safety Precautions

- For models with built-in operation indicators, check the coil polarity when wiring and wire all connections correctly (DC operation).
- Use only combinations of OMRON Relays and Sockets.

Relay Replacement

To replace the Relay, turn OFF the power supply to the load and Relay coil sides to prevent unintended operation and possible electrical shock.

Latching Relays: MY2K

Specifications

Coil Rating

Item	Rated voltage (V)	Set coil			Reset coil			Set voltage (V)	Reset voltage (V)	Maximum voltage (V)	Power consumption (VA, W)	
		Rated current (mA)		Coil resistance (Ω)	Rated current (mA)		Coil resistance (Ω)				Set coil	Reset coil
		50 Hz	60 Hz		50 Hz	60 Hz						
AC	12	57	56	72	39	38.2	130	80% max.	80% max.	110% max. of rated voltage	Approx. 0.6 to 0.9 (at 60 Hz)	Approx. 0.2 to 0.5 (at 60 Hz)
	24	27.4	26.4	320	18.6	18.1	550					
	100	7.1	6.9	5,400	3.5	3.4	3,000					
DC	12	110		110	50		235	80% max.	80% max.	110% max. of rated voltage	Approx. 1.3	Approx. 0.6
	24	52		470	25		940					
	48	27		1,800	16		3,000					

- Note:**
- The rated current for AC is the value measured with a DC ammeter in half-wave rectification.
 - The rated current and coil resistance are measured at a coil temperature of 23°C with tolerances of +15%/–20% for the AC rated current and ±15% for the DC coil resistance.
 - The AC coil resistance is a reference value only.
 - Operating characteristics were measured at a coil temperature of 23°C.
 - The maximum voltage capacity was measured at an ambient temperature of 23°C.

Contact Ratings

Item	Load	Resistive load	Inductive load ($\cos \phi = 0.4$, $L/R = 7$ ms)
Rated load		3 A at 220 VAC 3 A at 24 VDC	0.8 A at 220 VAC 1.5 A at 24 VDC
Rated carry current		3 A	
Maximum contact voltage		250 VAC, 125 VDC	
Maximum contact current		3 A	
Contact form		DPDT	
Contact materials		Au plating + Ag	
Ambient operating temperature		–55 to 60° C*	
Ambient operating humidity		5% to 85%	

* With no icing or condensation.

Characteristics

Contact resistance* ¹		50 mΩ max.
Set	Time* ²	AC: 30 ms max., DC: 15 ms max.
	Minimum pulse width	AC: 60 ms, DC: 30 ms
Reset	Time* ²	AC: 30 ms max., DC: 15 ms max.
	Minimum pulse width	AC: 60 ms, DC: 30 ms
Maximum operating frequency	Mechanical	18,000 operations/h
	Rated load	1,800 operations/h
Insulation resistance* ³		100 MΩ
Dielectric strength	Between coil and contacts	1,500 VAC at 50/60 Hz for 1 min.
	Between contacts of different polarity	
	Between contacts of the same polarity	1,000 VAC at 50/60 Hz for 1 min.
Between set/reset coils		
Vibration resistance	Destruction	10 to 55 to 10 Hz, 0.5-mm single amplitude (1.0-mm double amplitude)
	Malfunction	10 to 55 to 10 Hz, 0.5-mm single amplitude (1.0-mm double amplitude)
Shock resistance	Destruction	1,000 m/s ²
	Malfunction	200 m/s ²
Endurance	Mechanical	100,000,000 operations min. (switching frequency: 18,000 operations/h)
	Electrical* ⁴	200,000 operations min. (at 1,800 operations/hr, rated load)
Failure rate P value (reference value)* ⁵		1 mA at 1 VDC
Weight		Approx. 30 g

Note: The above values are initial values.

- *¹. Measurement conditions: 1 A at 5 VDC using the voltage drop method
 *². Measurement conditions: With rated operating power applied, not including contact bounce.
 *³. Measurement conditions: For 500 VDC applied to the same location as for dielectric strength measurement.
 *⁴. Ambient temperature condition: 23° C
 *⁵. This value was measured at a switching frequency of 120 operations per minute.

MY(S) Engineering Data

MY2K

Maximum Switching Capacity

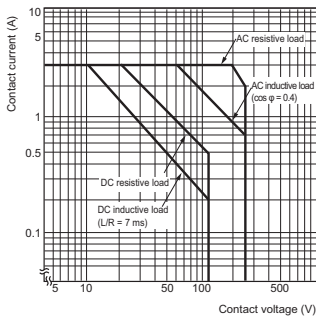

Endurance Curve

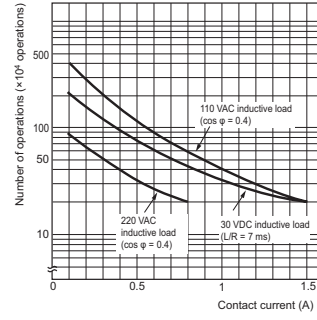
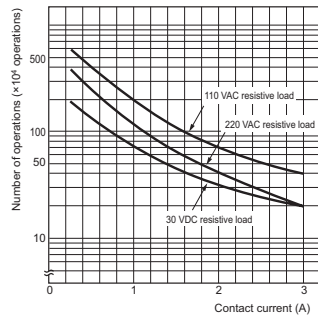

MY2K 100 VAC Malfunctioning Shock

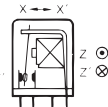
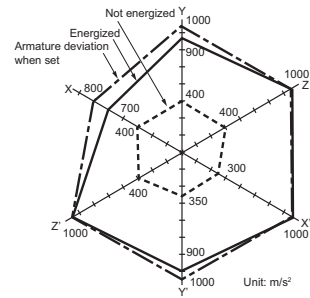

N = 20
Measurement: Shock was applied 2 times each in 6 directions along 3 axes with the Relay energized and not energized to check the shock values that cause the Relay to malfunction.
Criteria: Non-energized: 200 m/s²
Energized: 200 m/s²

MY2K 24 VDC Magnetic Interference (External Magnetic Field)

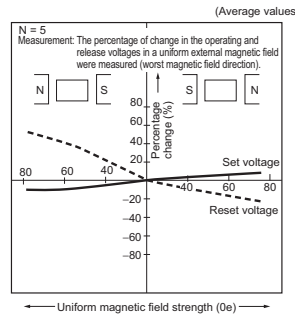

Latching Deterioration Over Time

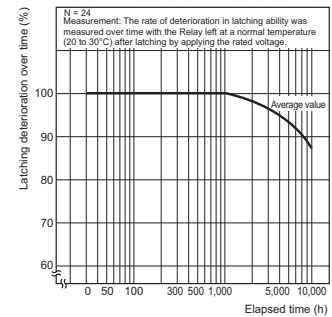

Dimensions

(Unit: mm)

Relays with Plug-in Terminals or Soldered Terminals MY2K

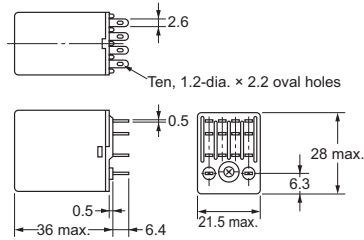
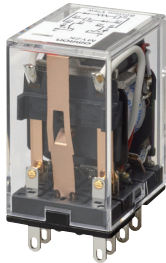

Terminal Arrangement/Internal Connections (Bottom View)

For AC

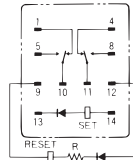

Note: R is a resistor for ampere-turn correction. This resistor is built-in to 50-VAC and higher models. (The coil has no polarity.)

Safety Precautions

- For applications that use a 200 VAC power supply, connect external resistors R_s and R_r to a 100 VAC Relay.
- Do not apply a voltage to the set and reset coils at the same time. If you apply the rated voltage to both coils simultaneously, the Relay will be set.
- The minimum pulse width in the performance column is the value for the following measurement conditions: an ambient temperature of 23°C with the rated operating voltage applied to the coil. The performance values given here may not be satisfied due to use over time and a reduction in latching performance due to changes in the ambient temperature or in the conditions of the application circuit.
For actual use, apply the rated operating voltage with a pulse width based on the actual load and reset the Relay at least once per year to prevent degradation over time.
- If the Relay is used in an environment with strong magnetic fields, the surrounding magnetic field can demagnetize the magnetic body and cause unintended operation. Therefore, do not use these Relays in environments with strong magnetic fields.

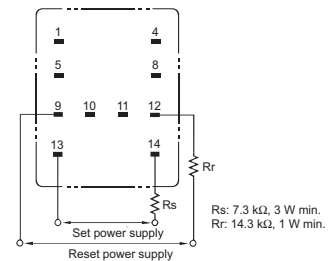

Relay Replacement

To replace the Relay, turn OFF the power supply to the load and Relay coil sides to prevent unintended operation and possible electrical shock.

Applicable Sockets

Use only combinations of OMRON Relays and Sockets.

Hermetically Sealed Relays: MY4(Z)H

Specifications

Contact Ratings

Item	Load	MY4H		MY4ZH	
		Resistive load	Inductive load cos φ = 0.4 L/R = 7 ms	Resistive load	Inductive load cos φ = 0.4 L/R = 7 ms
Rated load	3 A at 110 VAC 3 A at 24 VDC	0.8 A at 110 VAC 1.5 A at 24 VDC	3 A at 110 VAC 3 A at 24 VDC	0.8 A at 110 VAC 1.5 A at 24 VDC	
Rated carry current	3 A				
Maximum contact voltage	125 VAC 125 VDC				
Maximum contact current	3 A				
Contact form	4DPDT		4DPDT (Bifurcated)		
Contact materials	Au plating + Ag				
Ambient operating temperature	-25 to 60° C*				
Ambient operating humidity	5% to 85%				

* With no icing or condensation.

Characteristics

Contact resistance*1	50 mΩ max.	
Operation time*2	20 ms max.	
Release time*2	20 ms max.	
Maximum operating frequency	Mechanical	18,000 operations/h
	Rated load	1,800 operations/h
Insulation resistance*4	100 MΩ min.	
Dielectric strength	Between coil and contacts	1,000 VAC at 50/60 Hz for 1 min. (700 VAC between contacts of the same polarity.)
	Between contacts of different polarity	
Vibration resistance	Destruction	10 to 55 to 10 Hz, 0.5-mm single amplitude (1.0-mm double amplitude)
	Malfunction	10 to 55 to 10 Hz, 0.5-mm single amplitude (1.0-mm double amplitude)
Shock resistance	Destruction	1,000 m/s ²
	Malfunction	200 m/s ²
Endurance	Mechanical	50,000,000 operations (5,000,000 operations*4) min. (operating frequency: 18,000 operations/h)
	Electrical*5	100,000 operations (50,000 operations*4) min. rated load, switching frequency: 1,800 operations/h
Failure rate P value (reference value)*6	Single contacts: 100 μA at 1 VDC Bifurcated contacts: 100 μA at 100 mVDC	
Weight	Approx. 50 g	

Note: The above values are initial values.

- *1. Measurement conditions: 1 A at 5 VDC using the voltage drop method
- *2. Measurement conditions: With rated operating power applied, not including contact bounce.
Ambient temperature condition: 23° C
- *3. Measurement conditions: For 500 VDC applied to the same location as for dielectric strength measurement.
- *4. This value is for bifurcated contacts.
- *5. Ambient temperature condition: 23° C
- *6. This value was measured at a switching frequency of 120 operations per minute.

Engineering Data

Maximum Switching Capacity MY4(Z)H

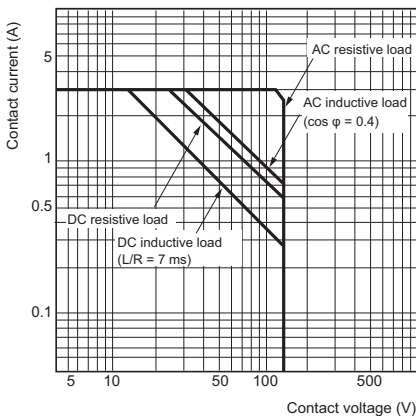

Endurance Curve MY4H

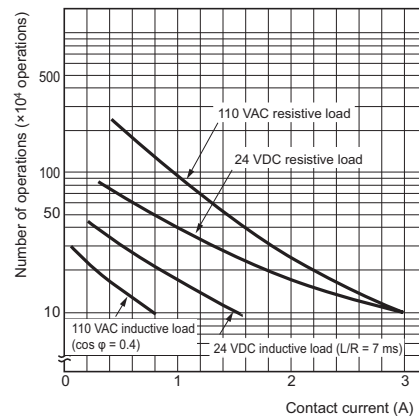

Note: The durability of bifurcated contacts is one-half that of single contacts.

MY(S)

Dimensions

(Unit: mm)

Relays with Plug-in Terminals or Soldered Terminals MY4(Z)H

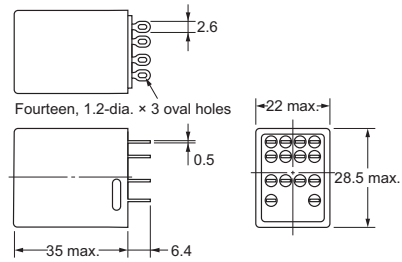

Terminal Arrangement/ Internal Connections (Bottom View)

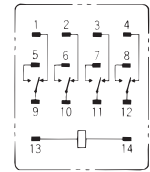

(The coil has no polarity.)

Safety Precautions

Applicable Sockets

Use only combinations of OMRON Relays and Sockets.

Application Environment for Hermetically Sealed Relays

Humid environments can cause insulation problems, which may result in short-circuiting or unintended operation.

Solution

Do not use these Relays in any environment where the Relay will come into contact with water vapor, condensation, or water droplets. This can reduce the surface tension of the insulating beads and cause short-circuiting or unintended operation due to poor insulation.

Relay Replacement

To replace the Relay, turn OFF the power supply to the load and Relay coil sides to prevent unintended operation and possible electrical shock.

Sockets for MY

DIN-rail-mounted (DIN-rail) Socket Conforms to VDE 0106, Part 100



- Snap into position along continuous sections of any mounting DIN-rail.
- Facilitates sheet metal design by standardized mounting dimensions.
- Design with sufficient dielectric separation between terminals eliminates the need of any insulating sheet.

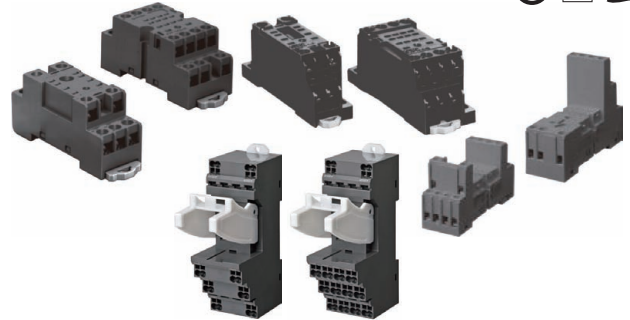

Safety Standards for Sockets Front-mounted Sockets (PYF□)

Model	Standards	File No.
PYF-08-PU PYF-14-PU	TÜV (EN 61984)	---
	UL508	E87929
	CSA C22.2 No.14	---
PYF14A-E, PYF14A-N	VDE0627 (EN61984)	Nr.B387 (License No.)
PYF08A-E, PYF08A-N PYF14A-E, PYF14A-N	TÜV(EN 61984)	J50224549
	UL508	E87929
	CSA22.2	LR31928
PYF14-ESN-B PFY14-ESS-B	UL508	E244189
	CSA22.2	LR225761
PYF08A PFY14A	UL508	E87929
	CSA22.2	LR31928

Back-connecting Sockets (PY□)

Model	Standards	File No.
PY08(-02) PY14(-02)	UL508	E87929
	CSA C22.2	LR31928

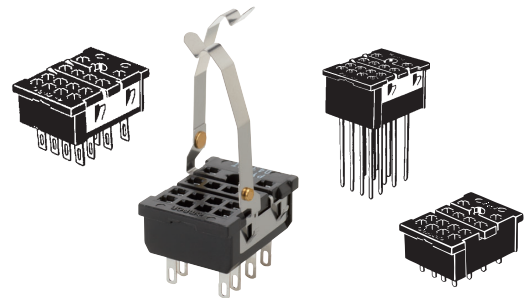

Specifications

Mounting	Terminal type	No. of poles	Model	Carry current	Dielectric withstand voltage	Insulation resistance (see note 2)	
DIN-rail-mounted Socket	Push-In Plus terminals	2	PYF-08-PU	10 A	2,000 VAC, 1 min	1,000 MΩ min	
		4	PYF-14-PU	6 A			
	Screw terminals	2	PYF08A(-E)	7 A	2,000 VAC, 1 min	1,000 MΩ min	
			PYF08A-N (see note 3)	7 A (see note 4)			
			4	PYF14A(-E)	5 A	2,000 VAC, 1 min	1,000 MΩ min
				PYF14A-N (see note 3)	5 A (see note 4)		
Rise-Up terminals		2 and 4 Common	PYF14-ESS-B	12 A	> 3 KV	> 5 MΩ	
			PYF14-ESN-B				
Back-connecting	Solder terminals	2	PY08(-Y1)	7 A	1,500 VAC, 1 min	1000 MΩ min.	
		4	PY14(-Y1)	3 A		100 MΩ min.	
	Wrapping terminals	2	PY08QN(-Y1)	7 A			
		4	PY14QN(-Y1)	3 A			
	Relays with PCB terminals		2	PY08-02			7 A
			4	PY14-02		3 A	

- Note:** 1. The values given above are initial values.
 2. The values for insulation resistance were measured at 500 VDC at the same place as the dielectric strength.
 3. The maximum operating ambient temperature for the PYF08A-N and PYF14A-N is 55°C.
 4. When using the PYF08A-N or PYF14A-N at an operating ambient temperature exceeding 40°C, reduce the current to 60%.
 5. The MY2(S) can be used at 70°C with a carry current of 7 A.

Options (Order Separately)

Connection Socket and Mounting Bracket Selection Table

(The possible combinations of models with plug-in terminals and sockets)

Connecting method Mounting method		Front-mounting Sockets (PYF□)				Back-mounting Sockets (PY□)						
		Track or screw mounting				Wrapping terminals						
		Screw terminals	Screw terminals (finger protection structure) *2	Rise-Up terminals	Push-In Plus Terminal Block *3	Solder terminals		Terminal length: 25 mm		Terminal length: 20 mm		Relays with PCB Terminals *4
Without Mounting Brackets *1	With Mounting Brackets							Without Mounting Brackets *1	With Mounting Brackets	Without Mounting Brackets *1	With Mounting Brackets	
No. of poles	Model	(Sold separately: Hold-down Clips) *1	Without Release Lever	With Release Lever	Without Mounting Brackets *1	With Mounting Brackets	Without Mounting Brackets *1	With Mounting Brackets	Without Mounting Brackets *1	With Mounting Brackets	(Sold separately : Hold-down Clips) *1	
8	MY2(S), MY2ZN (except for MY2K□, MY2Z□-CR)	PYF08A (PYC-A1)	PYF08A-E (PYC-A1) PYF08A-N (PYC-A1)	PYF-08-PU	PY08 (PYC-P)	PY08-Y1	PY08QN (PYC-P)	PY08QN-Y1	PY08QN2 (PYC-P)	PY08QN2-Y1	PY08-02 (PYC-P)	
	MY2I(S) *5	PYF08A (PYC-E1)	PYF08A-E (PYC-E1) PYF08A-N (PYC-E1)		PY08 (PYC-1)	PY08-Y3	PY08QN (PYC-1)	/	PY08QN2 (PYC-1)	/	PY08-02 (PYC-1)	
	MY2Z□-CR *6	PYF08A (Y92H-3)	PYF08A-E (Y92H-3) PYF08A-N (Y92H-3)		PY08 (PYC-1)	PY08-Y3	PY08QN (PYC-1)	/	PY08QN2 (PYC-1)	/	PY08-02 (PYC-1)	
14	MY4(S), MY4I(S), MY4-CBG, MY4Q, MY4(Z)H, MY2K	PYF14A (PYC-A1)	PYF14A-E (PYC-A1) PYF14A-N (PYC-A1)	PYF-14-PU	PY14 (PYC-P)	PY14-Y1	PY14QN (PYC-P)	PY14QN-Y1	PY14QN2 (PYC-P)	PY14QN2-Y1	PY14-02 (PYC-P)	

- Note:** Refer to Common Socket and DIN Track Products for the external dimensions of the Socket Relays and details on Hold-down Clips.
 *1. The information in parentheses is the model number of the applicable Mounting Bracket. Mounting Brackets are sold in sets of two. However, the PYC-P is just one Mounting Bracket.
 *2. The PYF□A-E has a terminal cover with finger protection. The Socket and Terminal Cover are integrated into one unit. Round terminals cannot be used. Use forked terminals or ferrules instead.
 *3. A Push-In Plus Terminal Block Socket functions as a release lever to hold or remove a Relay. Refer to PYF-□□-PU/P2RF-□□-PU for details.
 *4. If an MYI□(S) Relay with a Latching Lever is used in combination with a PY□-02 Socket for Relays with PCB Terminal Socket and PYC-P Mounting Brackets, the lever will not operate.
 *5. We recommend using the PYC-E1 Mounting Bracket for a MY2I(S) Relay with Latching Lever. (If the PYC-A1 is used with the MY2I(S), the latching lever will be blocked by the Mounting Bracket and the lever will not operate.)
 *6. The Mounting Brackets are applicable for Relays with a height of 36 mm or less. If the Relay height is greater than 53 mm, use Y92H-3 for the Front-mounting Socket and PYC-1 for the Back-mounting Socket. (The Y92H-3 is a set of two Brackets and the PYC-1 is just one Bracket.)

Mounting Plates for Sockets

Socket model	For 1 Socket	For 18 Sockets	For 36 Sockets
PY08, PY08QN(2), PY14, PY14QN(2)	PYP-1	PYP-18	PYP-36

Note: PYP-18 and PYP-36 can be cut into any desired length in accordance with the number of Sockets.

DIN-rail and Accessories

Supporting DIN-rail (length = 500 mm)	PFP-50N
Supporting DIN-rail (length = 1,000 mm) PFP	PFP-100N, PFP-100N2
End Plate	PFP-M
Spacer	PFP-S

Mounting Heights with Sockets (Unit: mm)

Front-mounting Sockets

Screw terminal

(PYF□A (-E), PYF□A-N, PYF14-ES□-B)

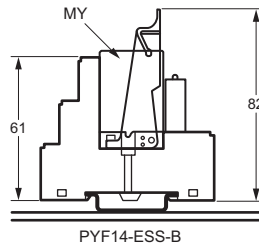
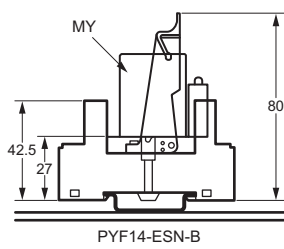
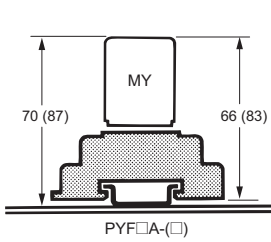

Push-In Plus Terminal Block Sockets (PYF□-PU)

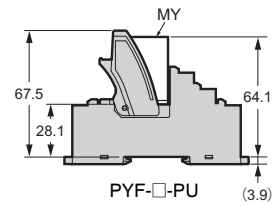

- Note:**
1. The PYF□A can be mounted on a track or with screws.
 2. The heights given in parentheses are the measurements for 53-mm-high Relays.

Back-mounting Sockets

Solder terminals/Wrapping terminals

(PY□)

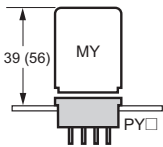

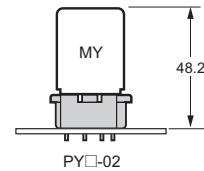

Relays with PCB Terminals (PY□-02)



Dimensions



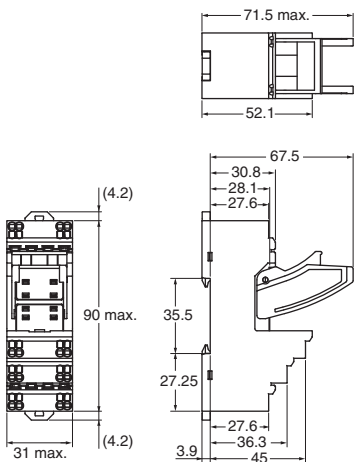
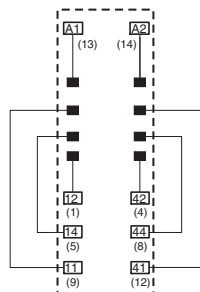
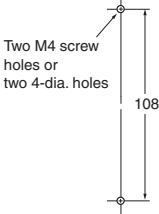

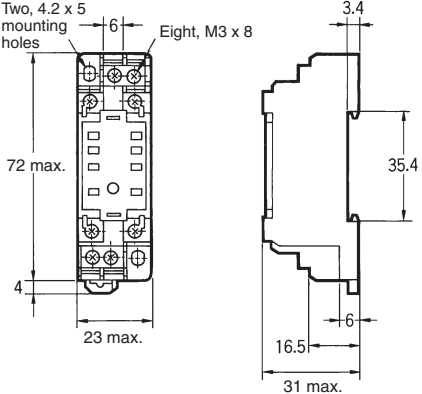
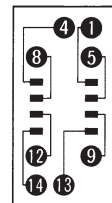
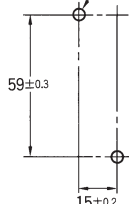
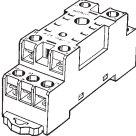
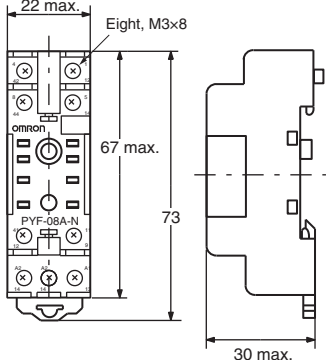
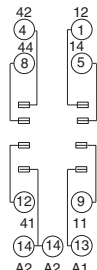
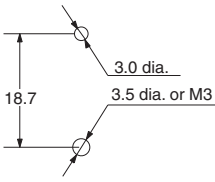
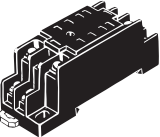
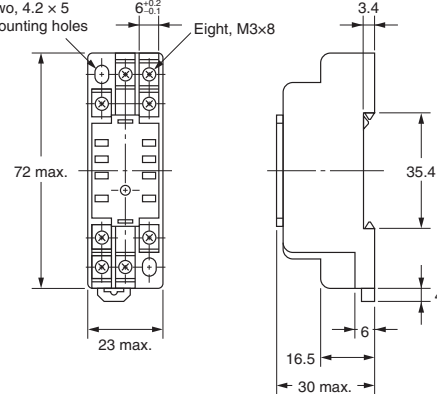
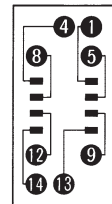
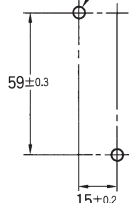
(Unit: mm)

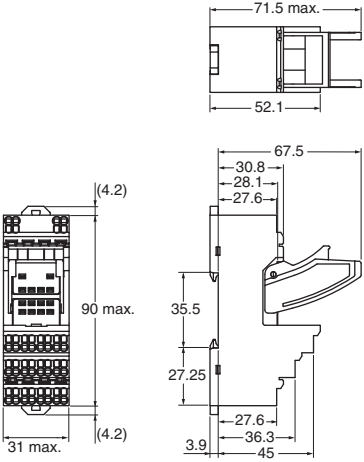
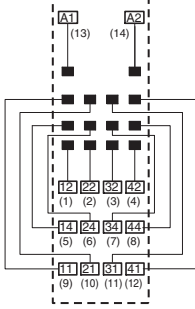
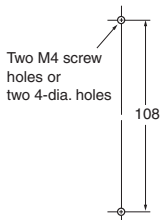
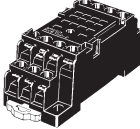
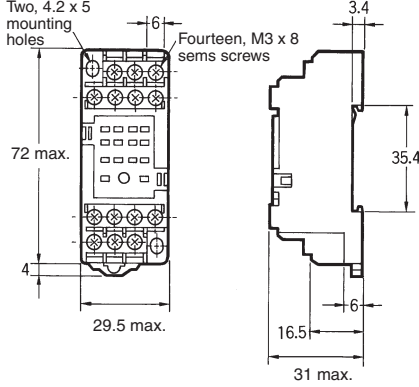
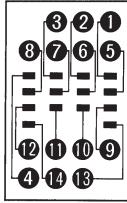
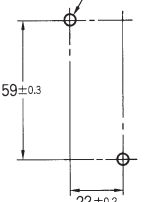
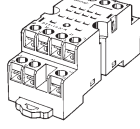
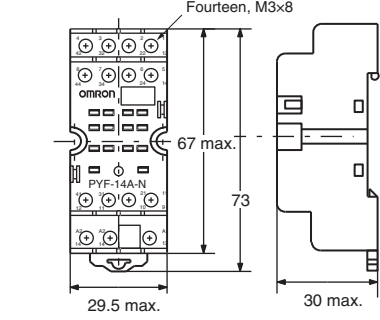
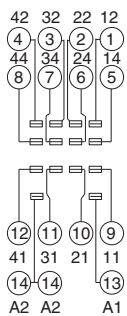
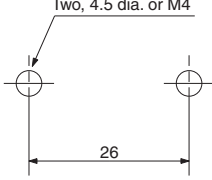
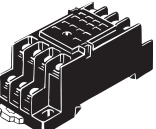
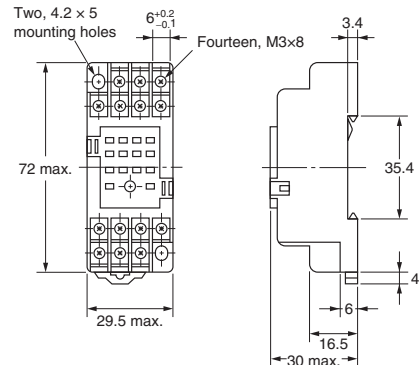
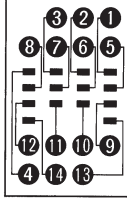
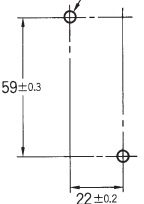

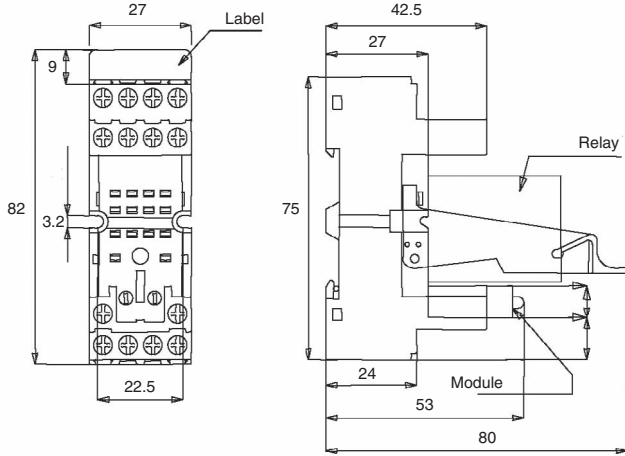
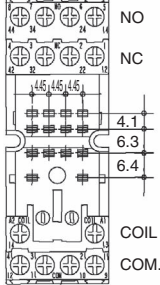

Note: All units are in millimeters unless otherwise indicated.

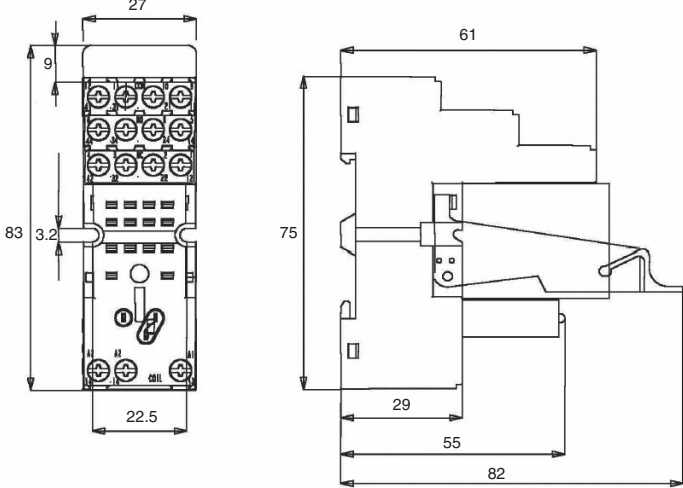
Socket	Dimensions	Terminal arrangement/ Internal connections (top view)	Mounting holes
<p>PYF-08-PU</p> 		 <p>Note: The numbers in parentheses are traditionally used terminal numbers.</p>	 <p>Two M4 screw holes or two 4-dia. holes</p> <p>108</p> <p>Note 1: Pull out the hooks to mount the Relay with screws.</p> <p>Note 2: DIN-rail mounting is also possible. Refer to page 34 for supporting DIN-rails.</p>
<p>PYF08A-E</p> 			 <p>Two, M3, M4, or 4.5-dia. holes</p> <p>59±0.3</p> <p>15±0.2</p> <p>(TOP VIEW)</p> <p>Note: DIN-rail mounting is also possible. Refer to page 34 for supporting DIN-rails.</p>
<p>PYF08A-N</p> 		 <p>Note: Figures in parentheses indicate DIN standard numbers.</p>	 <p>3.0 dia.</p> <p>18.7</p> <p>3.5 dia. or M3</p> <p>Note: DIN-rail mounting is also possible. Refer to page 34 for supporting DIN-rails.</p>
<p>PYF08A</p> 			 <p>Two, M3, M4, or 4.5-dia. holes</p> <p>59±0.3</p> <p>15±0.2</p> <p>(TOP VIEW)</p> <p>Note: DIN-rail mounting is also possible. Refer to page 34 for supporting DIN-rails.</p>

Socket	Dimensions	Terminal arrangement/ Internal connections (top view)	Mounting holes
<p>PYF-14-PU</p> 	 <p>71.5 max. 52.1 67.5 30.8 28.1 27.6 90 max. 35.5 27.25 31 max. 4.2 4.2 3.9 27.6 36.3 45</p>	 <p>Note: The numbers in parentheses are traditionally used terminal numbers.</p>	 <p>Two M4 screw holes or two 4-dia. holes 108</p> <p>Note 1: Pull out the hooks to mount the Relay with screws. Note 2: DIN-rail mounting is also possible. Refer to page 34 for supporting DIN-rails.</p>
<p>PYF14A-E</p> 	 <p>Two, 4.2 x 5 mounting holes 6 Fourteen, M3 x 8 sems screws 3.4 72 max. 35.4 4 29.5 max. 16.5 6 31 max.</p>		 <p>Two, M3, M4, or 4.5-dia. holes 59±0.3 22±0.2 (TOP VIEW)</p> <p>Note: DIN-rail mounting is also possible. Refer to page 34 for supporting DIN-rails.</p>
<p>PYF14A-N</p> 	 <p>Fourteen, M3x8 67 max. 73 29.5 max. 30 max.</p>	 <p>Note: Figures in parentheses indicate DIN standard numbers.</p>	 <p>Two, 4.5 dia. or M4 26</p> <p>Note: DIN-rail mounting is also possible. Refer to page 34 for supporting DIN-rails.</p>
<p>PYF14A</p> 	 <p>Two, 4.2 x 5 mounting holes 6^{+0.2}_{-0.1} Fourteen, M3x8 3.4 72 max. 35.4 4 29.5 max. 16.5 6 30 max.</p>		 <p>Two, M3, M4, or 4.5-dia. holes 59±0.3 22±0.2 (TOP VIEW)</p> <p>Note: DIN-rail mounting is also possible. Refer to page 34 for supporting DIN-rails.</p>

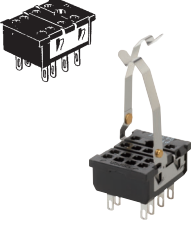
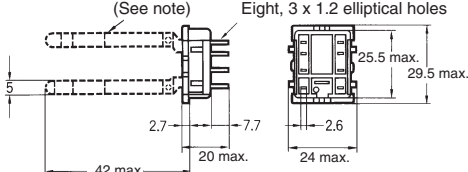
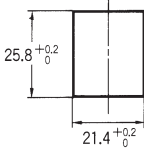
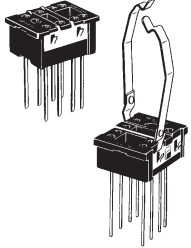
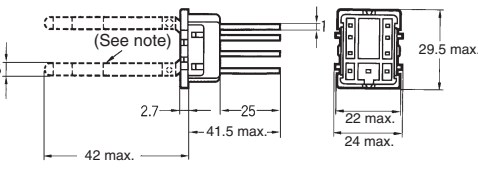
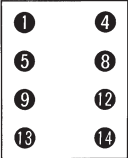
MY(S)

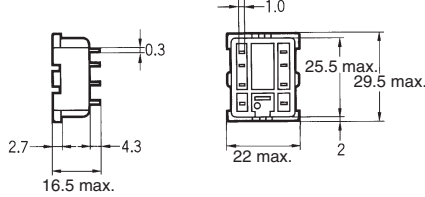
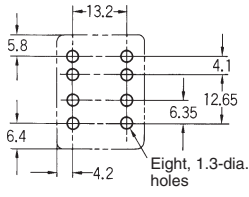
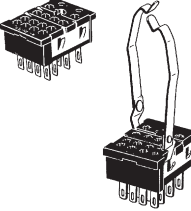
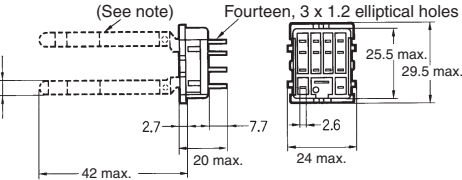
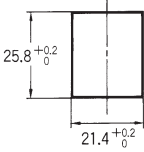
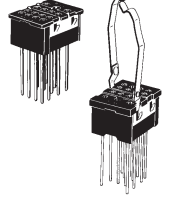
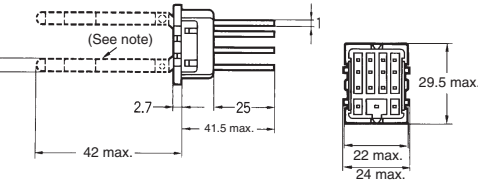
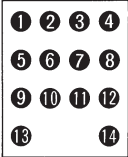
Socket	Dimensions	Terminal arrangement/ Internal connections (top view)/ mounting holes
<p>PYF14-ESN-B</p> 	 <p>Dimensions for PYF14-ESN-B and PYC-35-B:</p> <ul style="list-style-type: none"> Top view: 27 (width), 82 (height), 3.2 (mounting hole offset), 22.5 (bottom width) Side view: 42.5 (total height), 27 (top width), 75 (module height), 24 (module offset), 53 (module width), 80 (total width) 	 <p>Terminal arrangement for PYF14-ESN-B:</p> <ul style="list-style-type: none"> NO (Normally Open) NC (Normally Closed) COIL COM. (Common) Mounting hole offsets: 4.1, 6.3, 6.4
<p>PYC-35-B</p> 		 <p>Dimensions for PYF14-ESS-B and PYC-35-B:</p> <ul style="list-style-type: none"> Top view: 27 (width), 83 (height), 3.2 (mounting hole offset), 22.5 (bottom width) Side view: 61 (total height), 75 (module height), 29 (module offset), 55 (module width), 82 (total width)
<p>PYF14-ESS-B</p> 	<p>PYC-35-B</p> 	

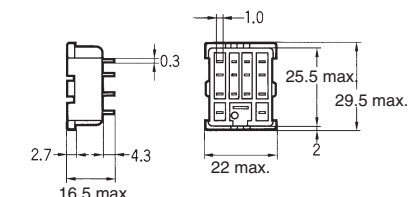
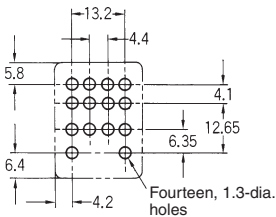
Socket	Dimensions	Terminal arrangement/ Internal connections (top view)	Mounting holes
<p>PY08/PY08-Y1</p> 	 <p>(See note) Eight, 3 x 1.2 elliptical holes</p> <p>25.5 max. 29.5 max. 42 max. 20 max. 2.7 7.7 2.6 24 max.</p> <p>Note: The PY08-Y1 includes sections indicated by dotted lines.</p>		 <p>25.8^{+0.2}₀ 21.4^{+0.2}₀</p>
<p>PY08QN/ PY08QN-Y1</p> 	 <p>(See note)</p> <p>29.5 max. 42 max. 2.7 25 41.5 max. 22 max. 24 max.</p> <p>Note: The PY08QN-Y1 includes sections indicated by dotted lines.</p>	 <p>1 4 5 8 9 12 13 14</p>	
<p>PY08-02</p> 	 <p>0.3 25.5 max. 29.5 max. 2.7 4.3 16.5 max. 1.0 22 max. 2</p>		 <p>13.2 5.8 4.1 12.65 6.4 6.35 4.2 Eight, 1.3-dia. holes</p>
<p>PY14/PY14-Y1</p> 	 <p>(See note) Fourteen, 3 x 1.2 elliptical holes</p> <p>25.5 max. 29.5 max. 42 max. 20 max. 2.7 7.7 2.6 24 max.</p> <p>Note: The PY14-Y1 includes sections indicated by dotted lines.</p>		 <p>25.8^{+0.2}₀ 21.4^{+0.2}₀</p>
<p>PY14QN/ PY14QN-Y1</p> 	 <p>(See note)</p> <p>29.5 max. 42 max. 2.7 25 41.5 max. 22 max. 24 max.</p> <p>Note: The PY14QN-Y1 includes sections indicated by dotted lines.</p>	 <p>1 2 3 4 5 6 7 8 9 10 11 12 13 14</p>	
<p>PY14-02</p> 	 <p>0.3 25.5 max. 29.5 max. 2.7 4.3 16.5 max. 1.0 22 max. 2</p>		 <p>13.2 5.8 4.4 4.1 12.65 6.4 6.35 4.2 Fourteen, 1.3-dia. holes</p>

Note: Use a panel with plate thickness of 1 to 2 mm for mounting the Sockets.

Short Bars for Relay Sockets and PYF Sockets

Short Bars for crossover wiring within one Socket or between Sockets

Application	Pitch	Applicable model	Appearance and dimensions (mm)	L (Length)	No. of poles	Model #	Specifications
For Contact terminals (common)	7.75 mm	PYF-□-PU		15.1	2	PYDN-7.75-020□	Max. carry current: 20 A Minimum order: 10
				22.85	3	PYDN-7.75-030□	
				30.6	4	PYDN-7.75-040□	
				154.6	20	PYDN-7.75-200□	
For Coil terminals	31.0 mm			224.35	8	PYDN-31.0-080□	

* Replace the box (□) in the model number with the specification code for the covering color. B: Black, S: Blue, R: Red

Note: When using short bar to coil terminals of PYF-□□-PU, make sure to use PYFDN-31.0-080□ (31mm).

Short bar correspondence table

	Contact terminal (Common)	Coil terminal	
		A1	A2
PYF-□□-PU	Available	○	○

Short Bars for within the Same Socket

Pitch	Applicable model	Appearance	Dimensions (mm)	No. of poles	Model #	Specifications
7 mm	PYF14A			2	PYD-020B□	Max. carry current: 20 A (18 A at 70°C) Ambient operating temp.: -40 to 70°C (with no icing or condensation) Ambient operating humidity: 45% to 85% (with no icing or condensation) Conductor material: Brass Conductor surface treatment: Nickel plating Qty per package: 50/bag
				3	PYD-030B□	

* Replace the box (□) in the model number with the specification code for the covering color. B: Black, Y: Yellow

Short Bars for Adjacent Sockets

Pitch	Applicable model	Appearance	Dimensions (mm)	No. of poles	Model #	Specifications
22 mm	PYF08A			2	PYD-025B□	Max. carry current: 20 A (18 A at 70°C) Ambient operating temp.: -40 to 70°C (with no icing or condensation) Ambient operating humidity: 45% to 85% (with no icing or condensation) Conductor material: Brass Conductor surface treatment: Nickel plating Qty per package: 10/bag
				8	PYD-085B□	
29 mm	PYF14A			2	PYD-026B□	Max. carry current: 20 A (18 A at 70°C) Ambient operating temp.: -40 to 70°C (with no icing or condensation) Ambient operating humidity: 45% to 85% (with no icing or condensation) Conductor material: Brass Conductor surface treatment: Nickel plating Qty per package: 10/bag
				8	PYD-086B□	

* Replace the box (□) in the model number with the specification code for the covering color. B: Black, S: Blue, R: Red

Safety Precautions

Maximum Carry Current

- Do not allow the total current for all shorted contact form to exceed the maximum carry current of the Short Bar.
- Do not exceed the maximum carry current of the relay contacts for individual contact form.
- If you use more than one Socket, use End Plates (PFP-M).

Hold-down Clips

PYC-A1
(2 pcs per set)

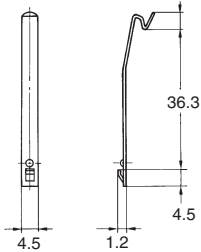

PYC-E1
(2 pcs per set)

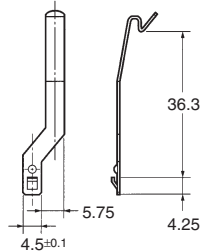

For sockets PYF14-ESN/ESS

Model	Description
PYC-0	Metal spring clip (Used with Relay only)
PYC 35	Plastic holding clip (Used with Relay only)
PYC TR1	Thermoplastic writable label

Note: For total dimensions with plastic clip please refer to drawings of the sockets.

PYC-P

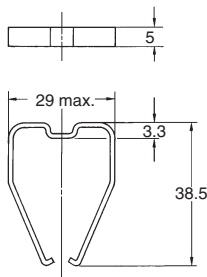

PYC-1

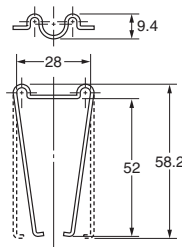

Y92H-3

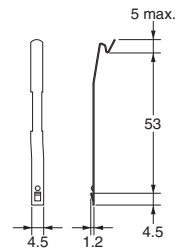

Mounting Plates for Back-connecting Sockets

PYP-1

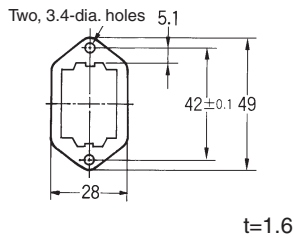

PYP-36

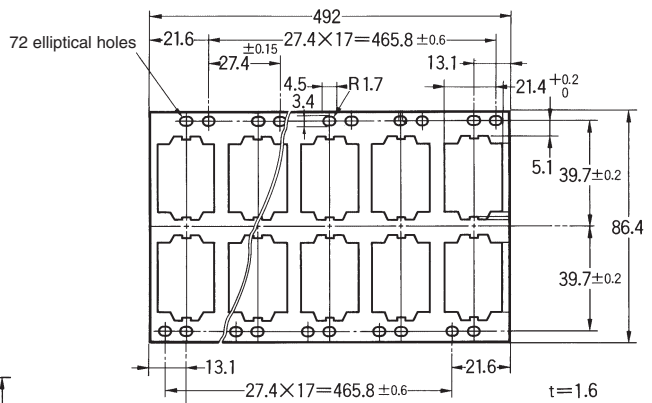

PYP-18

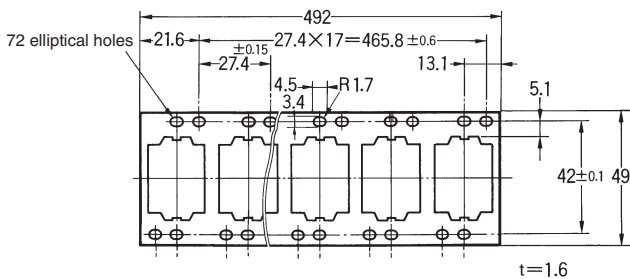

DIN-rails and Accessories

Supporting DIN-rails

PFP-50N/PFP-100N

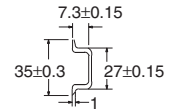
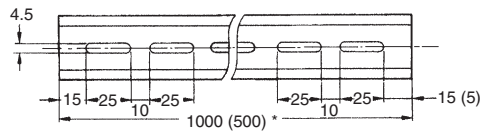
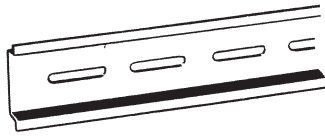

Note: The figure in the parentheses is for PFP-50N.

PFP-100N2

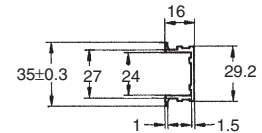
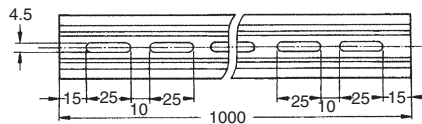
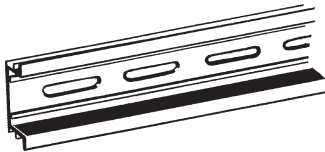

End Plate

PFP-M

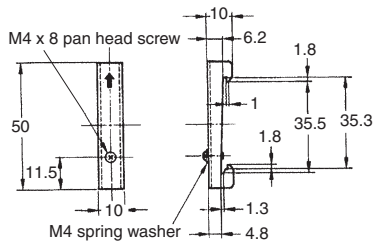

Spacer

PFP-S

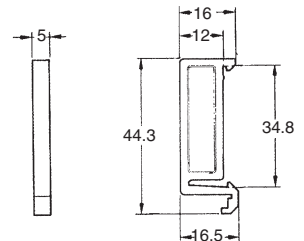

Safety Precautions

Refer to the *Common Relay Precautions*.

Refer to *Products Related to Common Sockets and DIN Tracks* for precautions on the applicable Sockets.

Refer to *PYF-□□-PU/P2RF-□□-PU* for precautions on Push-In Plus Terminal Block Sockets.

Precautions for Correct Use

Handling

For models with a built-in operation indicator, models with a built-in diode, or high-sensitivity models, check the coil polarity when wiring and wire all connections correctly (DC operation).

Installation

- There is no specifically required installation orientation, but make sure that the Relays are installed so that the contacts are not subjected to vibration or shock in their movement direction.

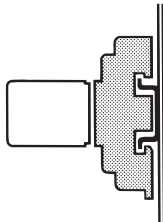

- Use two M3 screws to attach Flange-mounted models (MY□F) and tighten the screws securely (tightening torque: 0.98 N•m).

Using MY-series Relays with Microloads with Infrequent Operation

If any standard MY-series Relays (e.g., MY4) are used infrequently to switch microloads, the contacts may become unstable and eventually result in poor contact. In this case, we recommend using the MY4Z-CBG Series, which has high contact reliability for microloads (Refer to page 15.)

About the Built-in Diode and CR Elements

The diode or CR element that are built into the Relay are designed to absorb the reverse voltage from the Relay coil. If a large surge in voltage is applied to the diode or CR element from an external source, the element will be destroyed. If there is the possibility of large voltage surges that could be applied to the elements from an external source, take any necessary surge absorption measures.

Latching Levers

- Turn OFF the power supply when operating the latching lever. After you use the latching lever always return it to its original state.
- Do not use the latching lever as a switch.
- The latching lever can be used for 100 operations min.

Relay Replacement

To replace the Relay, turn OFF the power supply to the load and Relay coil sides to prevent unintended operation and possible electrical shock.

Terms and Conditions Agreement

Read and understand this catalog.

Please read and understand this catalog before purchasing the products. Please consult your OMRON representative if you have any questions or comments.

Warranties.

- (a) Exclusive Warranty. Omron's exclusive warranty is that the Products will be free from defects in materials and workmanship for a period of twelve months from the date of sale by Omron (or such other period expressed in writing by Omron). Omron disclaims all other warranties, express or implied.
- (b) Limitations. OMRON MAKES NO WARRANTY OR REPRESENTATION, EXPRESS OR IMPLIED, ABOUT NON-INFRINGEMENT, MERCHANTABILITY OR FITNESS FOR A PARTICULAR PURPOSE OF THE PRODUCTS. BUYER ACKNOWLEDGES THAT IT ALONE HAS DETERMINED THAT THE PRODUCTS WILL SUITABLY MEET THE REQUIREMENTS OF THEIR INTENDED USE.

Omron further disclaims all warranties and responsibility of any type for claims or expenses based on infringement by the Products or otherwise of any intellectual property right. (c) Buyer Remedy. Omron's sole obligation hereunder shall be, at Omron's election, to (i) replace (in the form originally shipped with Buyer responsible for labor charges for removal or replacement thereof) the non-complying Product, (ii) repair the non-complying Product, or (iii) repay or credit Buyer an amount equal to the purchase price of the non-complying Product; provided that in no event shall Omron be responsible for warranty, repair, indemnity or any other claims or expenses regarding the Products unless Omron's analysis confirms that the Products were properly handled, stored, installed and maintained and not subject to contamination, abuse, misuse or inappropriate modification. Return of any Products by Buyer must be approved in writing by Omron before shipment. Omron Companies shall not be liable for the suitability or unsuitability or the results from the use of Products in combination with any electrical or electronic components, circuits, system assemblies or any other materials or substances or environments. Any advice, recommendations or information given orally or in writing, are not to be construed as an amendment or addition to the above warranty.

See <http://www.omron.com/global/> or contact your Omron representative for published information.

Limitation on Liability; Etc.

OMRON COMPANIES SHALL NOT BE LIABLE FOR SPECIAL, INDIRECT, INCIDENTAL, OR CONSEQUENTIAL DAMAGES, LOSS OF PROFITS OR PRODUCTION OR COMMERCIAL LOSS IN ANY WAY CONNECTED WITH THE PRODUCTS, WHETHER SUCH CLAIM IS BASED IN CONTRACT, WARRANTY, NEGLIGENCE OR STRICT LIABILITY.

Further, in no event shall liability of Omron Companies exceed the individual price of the Product on which liability is asserted.

Suitability of Use.

Omron Companies shall not be responsible for conformity with any standards, codes or regulations which apply to the combination of the Product in the Buyer's application or use of the Product. At Buyer's request, Omron will provide applicable third party certification documents identifying ratings and limitations of use which apply to the Product. This information by itself is not sufficient for a complete determination of the suitability of the Product in combination with the end product, machine, system, or other application or use. Buyer shall be solely responsible for determining appropriateness of the particular Product with respect to Buyer's application, product or system. Buyer shall take application responsibility in all cases.

NEVER USE THE PRODUCT FOR AN APPLICATION INVOLVING SERIOUS RISK TO LIFE OR PROPERTY OR IN LARGE QUANTITIES WITHOUT ENSURING THAT THE SYSTEM AS A WHOLE HAS BEEN DESIGNED TO ADDRESS THE RISKS, AND THAT THE OMRON PRODUCT(S) IS PROPERLY RATED AND INSTALLED FOR THE INTENDED USE WITHIN THE OVERALL EQUIPMENT OR SYSTEM.

Programmable Products.

Omron Companies shall not be responsible for the user's programming of a programmable Product, or any consequence thereof.

Performance Data.

Data presented in Omron Company websites, catalogs and other materials is provided as a guide for the user in determining suitability and does not constitute a warranty. It may represent the result of Omron's test conditions, and the user must correlate it to actual application requirements. Actual performance is subject to the Omron's Warranty and Limitations of Liability.

Change in Specifications.

Product specifications and accessories may be changed at any time based on improvements and other reasons. It is our practice to change part numbers when published ratings or features are changed, or when significant construction changes are made. However, some specifications of the Product may be changed without any notice. When in doubt, special part numbers may be assigned to fix or establish key specifications for your application. Please consult with your Omron's representative at any time to confirm actual specifications of purchased Product.

Errors and Omissions.

Information presented by Omron Companies has been checked and is believed to be accurate; however, no responsibility is assumed for clerical, typographical or proofreading errors or omissions.

OMRON Corporation Industrial Automation Company
Kyoto, JAPAN

Contact: www.ia.omron.com

Regional Headquarters

OMRON EUROPE B.V.

Wegalaan 67-69, 2132 JD Hoofddorp
The Netherlands
Tel: (31)2356-81-300/Fax: (31)2356-81-388

OMRON ELECTRONICS LLC

2895 Greenspoint Parkway, Suite 200
Hoffman Estates, IL 60169 U.S.A
Tel: (1) 847-843-7900/Fax: (1) 847-843-7787

OMRON ASIA PACIFIC PTE. LTD.

No. 438A Alexandra Road # 05-05/08 (Lobby 2),
Alexandra Technopark,
Singapore 119967
Tel: (65) 6835-3011/Fax: (65) 6835-2711

OMRON (CHINA) CO., LTD.

Room 2211, Bank of China Tower,
200 Yin Cheng Zhong Road,
PuDong New Area, Shanghai, 200120, China
Tel: (86) 21-5037-2222/Fax: (86) 21-5037-2200

Authorized Distributor:

© OMRON Corporation 2015-2016 All Rights Reserved.
In the interest of product improvement,
specifications are subject to change without notice.

Cat. No. J199-E1-03

0316 (0115)