

# Terminal Block Accessories

## Double Row - Top Mounted Covers/Marking Strips

### Specifications:

- White vinyl material, 0.03" thick
- Two nylon spring clips for mounting provided
- Marking strips: printed on center line with letters or numbers for circuit identification
- Covers: printed on top, bottom or center line with letters or numbers for circuit identification
- Printing character size is 1/8 inch
- Unless otherwise specified, the marking goes down the center of the cover for print styles 01A, 01B, 01C, 01D
- Marking goes down the 2 sides of the cover for print styles 07A, 07B, 07C, 07D



# of Terminals	Series 1 100/670A GP, 600 GP, 600A GP, 670A RZ		Series 2 200/671 GP, 601 GP, 621 RZ, 671 RZ		Series 3 300/672GP 602 GP, 672 RZ	
	A	B	A	B	A	B
1	0.91	0.55	1.01	0.65	1.16	0.80
2	1.29	0.93	1.44	1.08	1.73	1.37
3	1.66	1.30	1.88	1.52	2.29	1.93
4	2.04	1.68	2.32	1.96	2.85	2.49
5	2.41	2.05	2.76	2.40	3.42	3.06
6	2.79	2.43	3.19	2.83	3.98	3.62
7	3.16	2.80	3.63	3.27	4.54	4.18
8	3.56	3.20	4.07	3.71	5.10	4.74
9	3.91	3.55	4.50	4.14	5.67	5.31
10	4.29	3.93	4.94	4.58	6.23	5.87
11	4.66	4.30	5.38	5.02	6.79	6.43
12	5.04	4.68	5.81	5.45	7.36	7.00
13	5.41	5.05	6.25	5.89	7.92	7.56
14	5.79	5.43	6.69	6.33	8.48	8.12
15	6.16	5.80	7.13	6.77	9.05	8.69
16	6.54	6.18	7.56	7.20	9.61	9.25
17	6.91	6.55	8.00	7.64	10.17	9.81
18	7.29	6.93	8.44	8.08	10.73	10.37
19	7.66	7.30	8.87	8.51	11.30	10.94
20	8.04	7.68	9.31	8.95	11.86	11.50
21	8.41	8.05	9.75	9.39	12.42	12.06
22	8.79	8.43	10.18	9.82	12.99	12.63
23	9.16	8.80	10.62	10.26	13.55	13.19
24	9.54	9.18	11.06	10.70	14.11	13.75
25	9.91	9.55	11.50	11.14	--	--
26	10.29	9.93	11.93	11.57	--	--
27	10.66	10.30	12.37	12.01	--	--
28	11.04	10.68	12.81	12.45	--	--
29	11.41	11.05	13.24	12.88	--	--
30	11.79	11.43	13.68	13.32	--	--
31	12.16	11.80	--	--	--	--
32	12.54	12.18	--	--	--	--
33	12.91	12.55	--	--	--	--
34	13.29	12.93	--	--	--	--
35	13.66	13.30	--	--	--	--
36	14.04	13.68	--	--	--	--

COVER

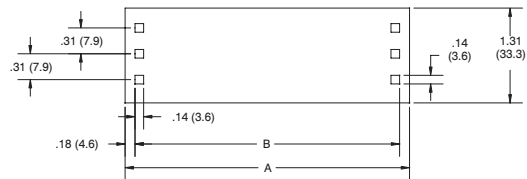

MARKING STRIP

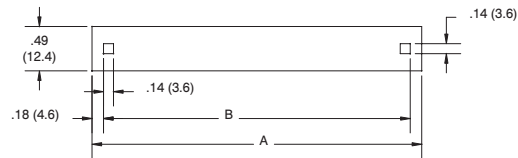

### Print Styles

01A	1 2 3 4 5 6 7	01C	← 2 3 4 5 6 7
01B	7 6 5 4 3 2 1	01D	7 6 5 4 3 2 1 ←
07A	7 6 5 4 3 2 1 1 2 3 4 5 6 7	07C	← 2 3 4 5 6 7 ← 2 3 4 5 6 7
07B	1 2 3 4 5 6 7 7 6 5 4 3 2 1	07D	7 6 5 4 3 2 1 ← 7 6 5 4 3 2 1 ←

### Ordering Codes

COVER	SERIES	NO. OF TERMINALS	PRINT STYLE
CW	2	05*	01A
CB (Black) CW (White) CC (Clear)	1/2/3 or 621		
MARKING STRIP	SERIES	NO. OF TERMINALS	PRINT STYLE
SW	2	05*	01A
SW (White)	1/2/3 or 621		Print styles 07A/B/C/D not available

BARRIER  
TERMINAL BLOCKS

# Terminal Block Accessories

## Marking and Insulator Strips; Sub-Mounted - Single Row & Double Row

Marking strips serve as insulation between terminal blocks and chassis, as well as providing a marking surface for terminal identification. When specified, they can be printed to show terminal designations by numbers, letters, symbols or any combination thereof. Insulator strips offer the same properties, but do not provide space for terminal identification. Both marking and insulator strips can be supplied pre-mounted on the back of each block thereby simplifying assembly and inventory control.

### Order Information:

**FEED-THRU STYLE:** For feed-thru terminal blocks, see styles 2, 3, 5, 6, 8, & 9 on page 114. Insert applicable feed-thru style designation in ordering code, i.e. Y, YSY, XY, 1904, 1921, 2000, 2004, 2020, 2021, 2104, 2120, 3000.

**AVAILABILITY:** Marking and insulator strips are available to fit most Terminal Blocks. See SERIES reference numbers on pages 113-114 for a complete listing. If not listed, consult Customer Service for availability. Designate appropriate prefix (MS for marking strips or IS for insulator strip) in front of the SERIES number when ordering. Available materials: XP (general purpose laminate), XXPFPR (flame retardant), GME (glass cloth melamine), GEE (glass cloth epoxy).

### Ordering Code:

Descriptions:	Strip Type	Series	Material	Feed Thru (if applicable)	Number of Terminals	Print Style
Example:	MS	671	XP	Y	16	01A
MS = Marking Strip		410	XP	Y	---	See
IS = Insulator Strip		411	XXPFPR	(Blank)		Printing
		599 (799)	GME			Style
		600 (800)	GEE			Selection
		601 (801)				
		602 (802)				
		603				
		604				
		605				
		621				
		670 (100)				
		671 (200)				
		672 (300)				
		699 (899)				
		812 (912)				

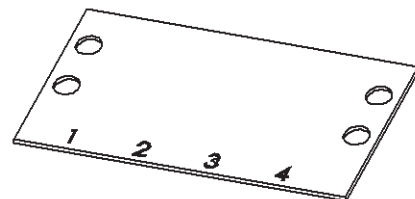

MS-xxx-XP-04-01A

# Terminal Block Accessories

## Marking Strip Dimensions - Double & Single Row

Series	Print Style	C*	D	E	F	X (dia)	Text Height	Figure
410	1-6	0.75	0.25	0.19	0.12	0.13	0.06	1
	7, 8, 9	1.13		0.44				
411	1, 2, 4, 5	0.56	n/a	0.19	0.13	0.13	0.06	2
	7, 8	0.88		0.44				
599 (799)	1, 2, 4, 5	0.81	n/a	0.28	0.14	0.16	0.13	2
	7, 8	1.13		0.56				
600 (800)	1-6	1.13	0.31	0.29	0.14	0.16	0.13	1
	7, 8, 9	1.38		0.53				
601 (801)	1-6	1.31	0.42	0.34	0.16	0.18	0.13	1
	7, 8, 9	1.50		0.55				
602 (802)	1-6	1.50	0.50	0.41	0.20	0.21	0.13	1
	7, 8, 9	1.75		0.63				
603	1-6	1.88	0.63	0.59	0.22	0.23	0.13	1
	7, 8, 9	2.13		0.75				
604	1, 4	2.13	0.75	0.63	0.27	0.23	0.13	1
	7	2.50		0.88				
605	1, 4	2.69	0.88	0.81	0.31	0.27	0.13	1
	7	2.81		0.97				
621	1, 4	1.88	0.42	0.51	0.16	0.18	0.13	1
670 (100)	1-6	1.19	0.31	0.28	0.14	0.16	0.13	1
	7, 8, 9	1.50		0.59				
671 (200)	1-6	1.50	0.42	0.34	0.16	0.18	0.13	1
	7, 8, 9	1.75		0.67				
672 (300)	1-6	1.63	0.50	0.41	0.20	0.21	0.13	1
	7, 8, 9	1.94		0.72				
699 (899)	1, 2, 4, 5	0.88	n/a	0.56	0.16	0.18	0.13	2
	7, 8	1.13		0.34				
812 (912)	1, 2, 4, 5	0.94	n/a	0.37	0.20	0.21	0.06	2
	7, 8	1.31		0.66			0.13	

BARRIER  
TERMINAL BLOCKS

Figure-1

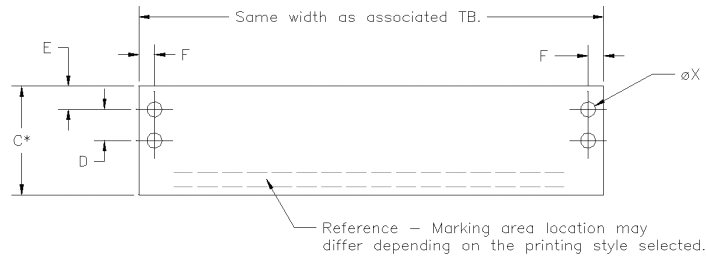
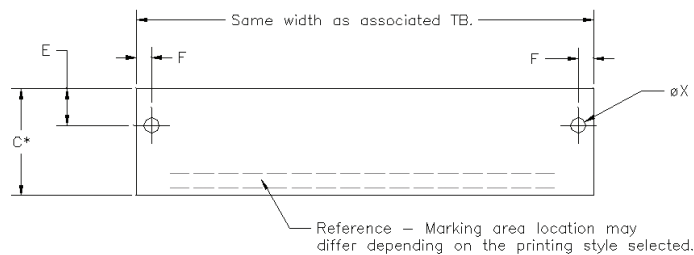

Figure-2



# Terminal Block Accessories

## Marking Strip Printing Styles - Double & Single Row

### Printing:

- Maximum number of characters is two.
- If unprinted marking strips are desired, insert the letter "X" in the print style order code.
- Printing color is black on white surfaces, and silver on black surfaces.
- Fungus proof coatings can be supplied per request per MIL-V-173A. State on order:  
"Coat after printing with MIL-V-173A varnish."

### Double Row

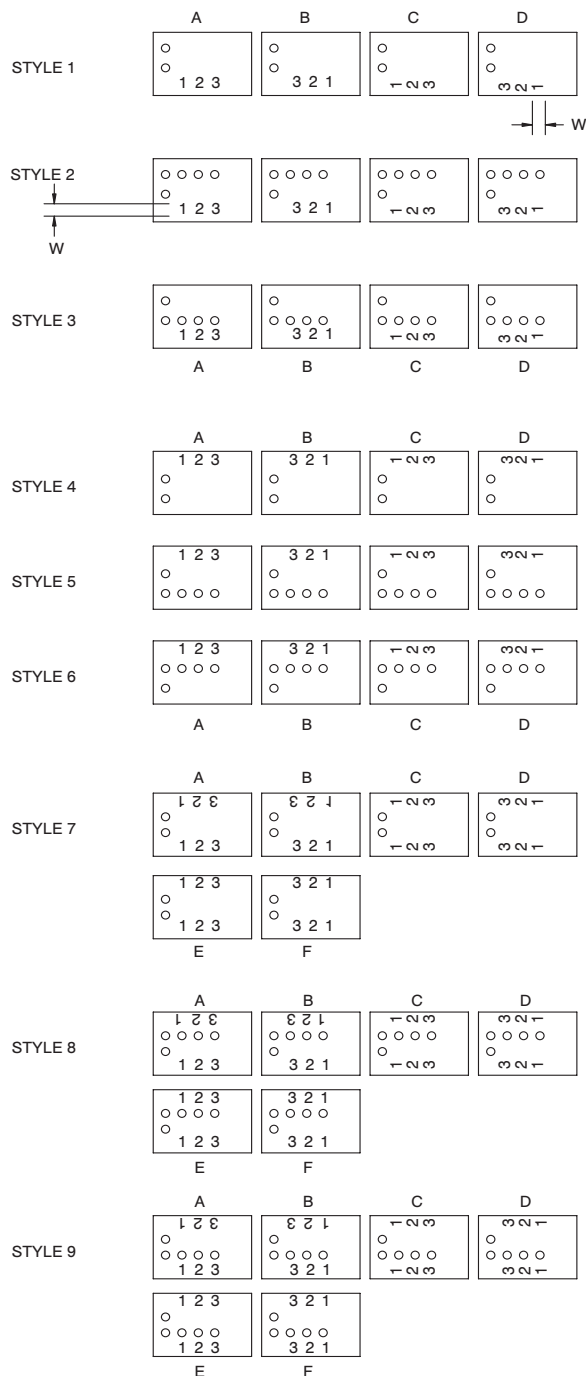

### Single Row

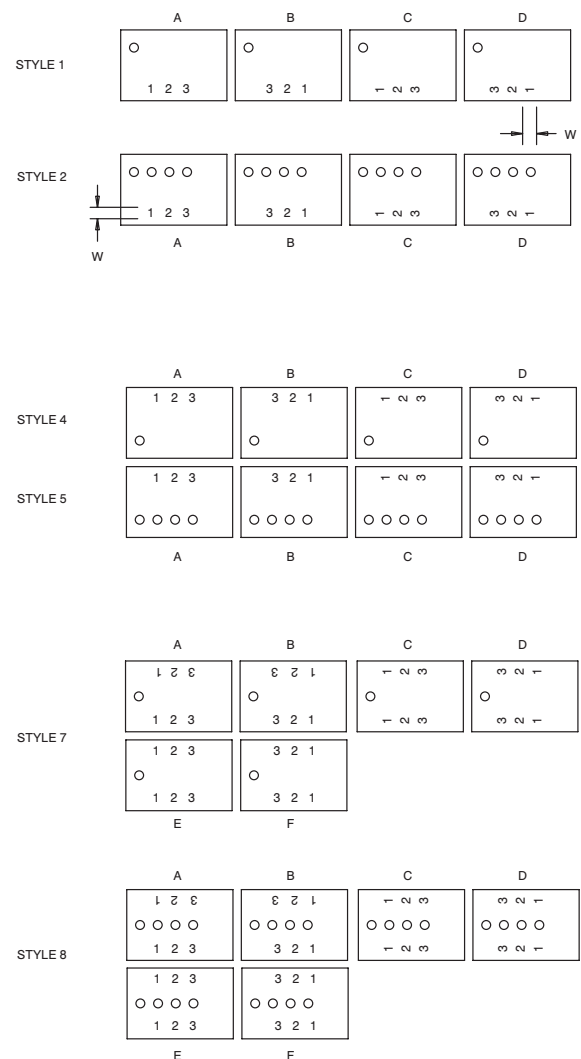

# Terminal Block Accessories

## Terminal Block Printing

### Numeric Print Styles



### Alpha Print Styles

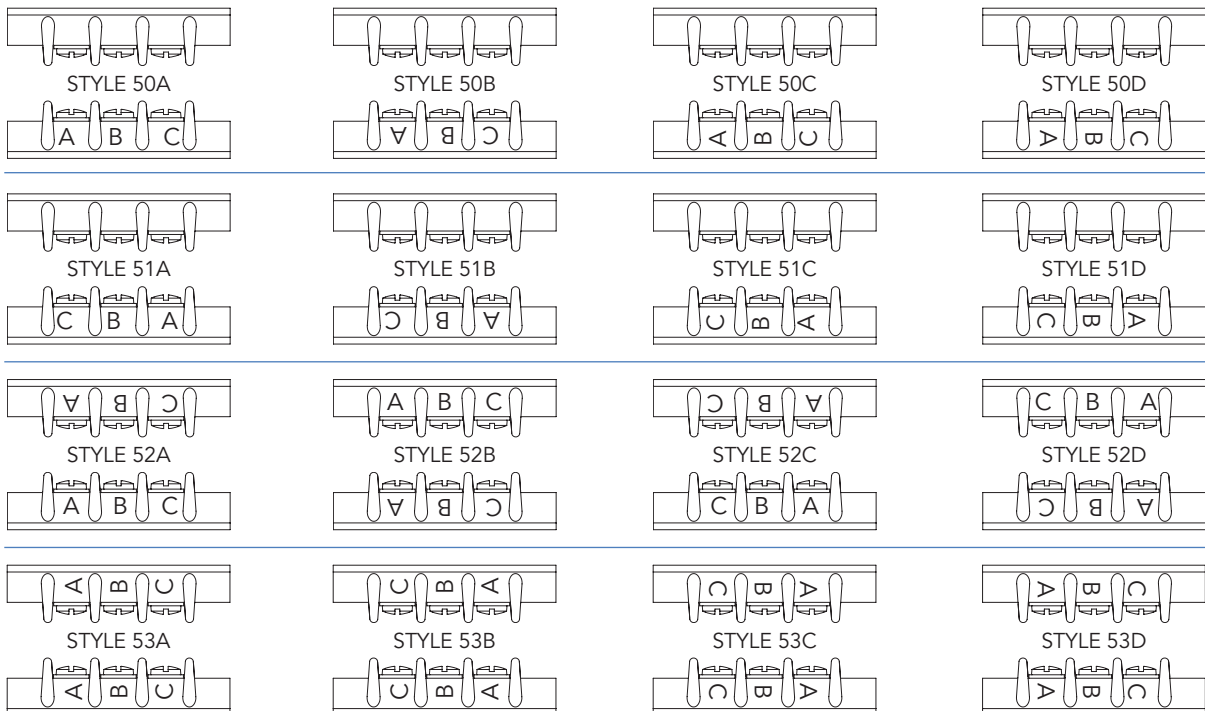

BARRIER  
TERMINAL BLOCKS

# Terminal Block Accessories

## Kliptite (Quick Connect) - Single Row

### Specifications:

Kliptite (Quick Connect) accept standard female wire terminals. These Kliptites are ideal for applications that require a positive, yet quick disconnect termination. Kliptites are assembled to the block with screws or, in some applications, riveted to the block.

Kliptites are available in 0°, 45° or 90° bends; one side or two side. Material: Brass; Finish: Tin

Screw Construction	Rivet Construction	Tab Width	Tab Thickness	(2) 0° tabs	(2) 45° tabs	(2) 90° tabs	(1) 0° tab	(1) 45° tab	(1) 90° tab
411 Series		<b>0.110</b>	0.020						
599 Series	799 Series	<b>0.187</b>	0.020						
699 Series	899 Series	<b>0.250</b>	0.032						
812 Series	912 Series	<b>0.250</b>	0.032						
1690 Series <sup>1</sup>		<b>0.250</b>	0.032						
2590 Series <sup>2</sup>		<b>0.187</b>	0.020						
2690 Series <sup>3</sup>		<b>0.250</b>	0.032						

- 1) 1690 Series insulated feed-thru blocks use the 699 Series Kliptites
- 2) 2590 Series use the 599 Series Kliptites
- 3) 2690 Series PC block use the 699 Kliptites

BARRIER  
TERMINAL BLOCKS

### TWO SIDE TABS

### ONE SIDE TABS

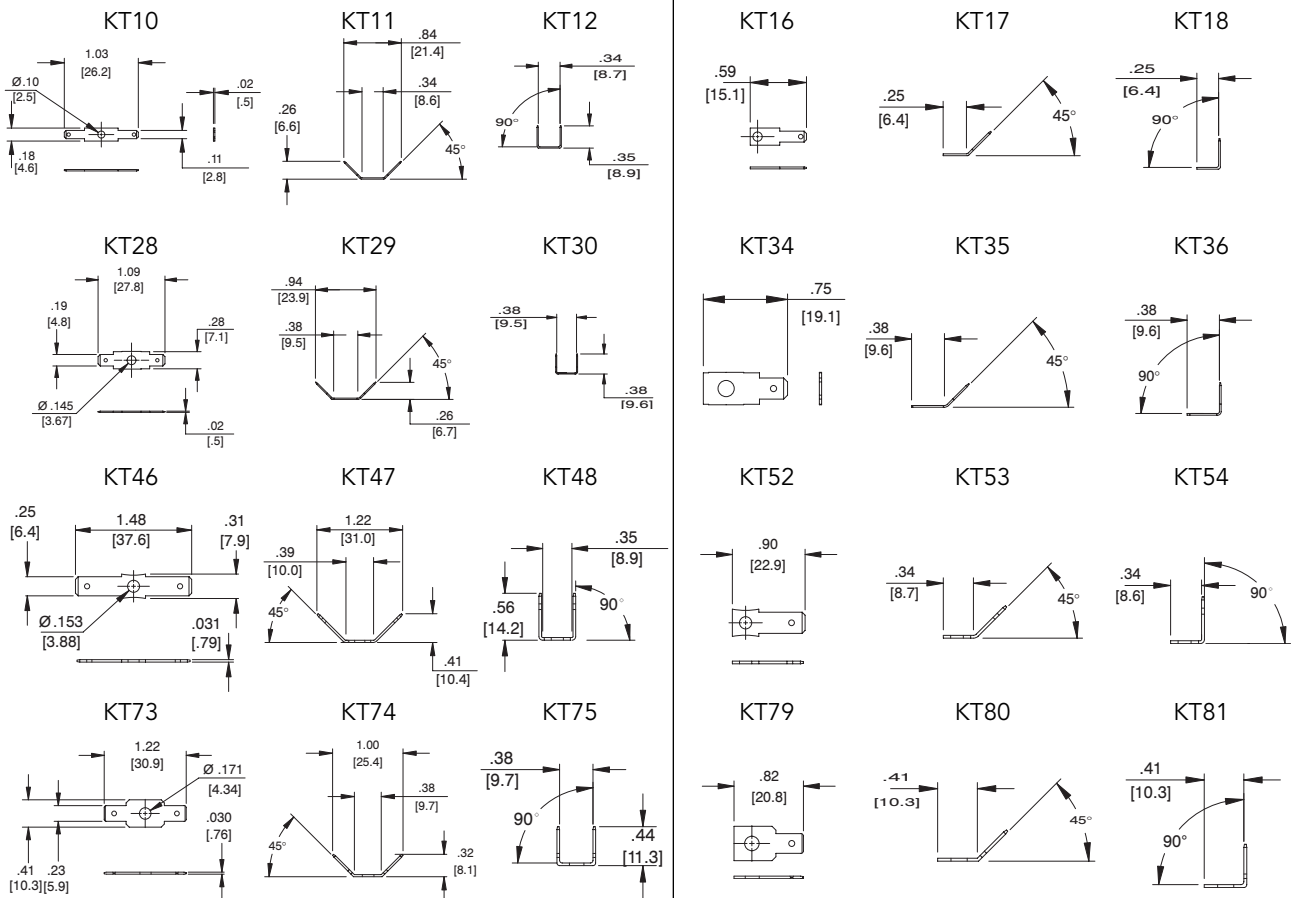

# Terminal Block Accessories

## Kliptite (Quick Connect) - Double Row

Series	Rivet Construction	Tab Width	Tab Thickness	(2) 0° tabs	(2) 45° tabs	(2) 90° tabs	(1) 0° tab	(1) 45° tab	(1) 90° tab
400		<b>0.250</b>	0.032	KT67	KT68	KT69	KT64	KT65	KT66
600 GP (600A)		<b>0.187</b>	0.020	KT19	KT20	KT21	KT25	KT26	KT27
601		<b>0.250</b>	0.032	KT37	KT38	KT39	KT43	KT44	KT45
602		<b>0.250</b>	0.032	KT55	KT56	KT57	KT61	KT62	KT63
603		<b>0.250</b>	0.032	KT67	KT68	KT69	KT64	KT65	KT66
621 RZ <sup>5</sup>		<b>0.250</b>	0.032	KT37	KT38	KT39	KT43	KT44	KT45
670A GP (100)		<b>0.187</b>	0.020	KT19	KT20	KT21	KT25	KT26	KT27
670A RZ Series <sup>4</sup>	801 Series	<b>0.187</b>	0.020	KT19	KT20	KT21	KT25	KT26	KT27
671 GP (200)	802 Series	<b>0.250</b>	0.032	KT37	KT38	KT39	KT43	KT44	KT45
671 RZ Series <sup>5</sup>		<b>0.250</b>	0.032	KT37	KT38	KT39	KT43	KT44	KT45
672 GP (300)		<b>0.250</b>	0.032	KT55	KT56	KT57	KT61	KT62	KT63
672 RZ Series <sup>6</sup>		<b>0.250</b>	0.032	KT55	KT56	KT57	KT61	KT62	KT63

4) 100, 670A GP, 670A RZ Series use the 600 Series Kliptites  
 5) 200, 671 GP, 671 RZ, 621 RZ Series use the 601 Series Kliptites  
 6) 300, 672 GP, 672 RZ Series use the 602 Series Kliptites

MSP Catalog Designations:  
 2-SIDE TABS: F1 (0°), F2 (45°), F3 (90°)  
 1-SIDE TABS: HF1 (0°), HF2 (45°), HF3 (90°)

BARRIER  
TERMINAL BLOCKS

### TWO SIDE TABS

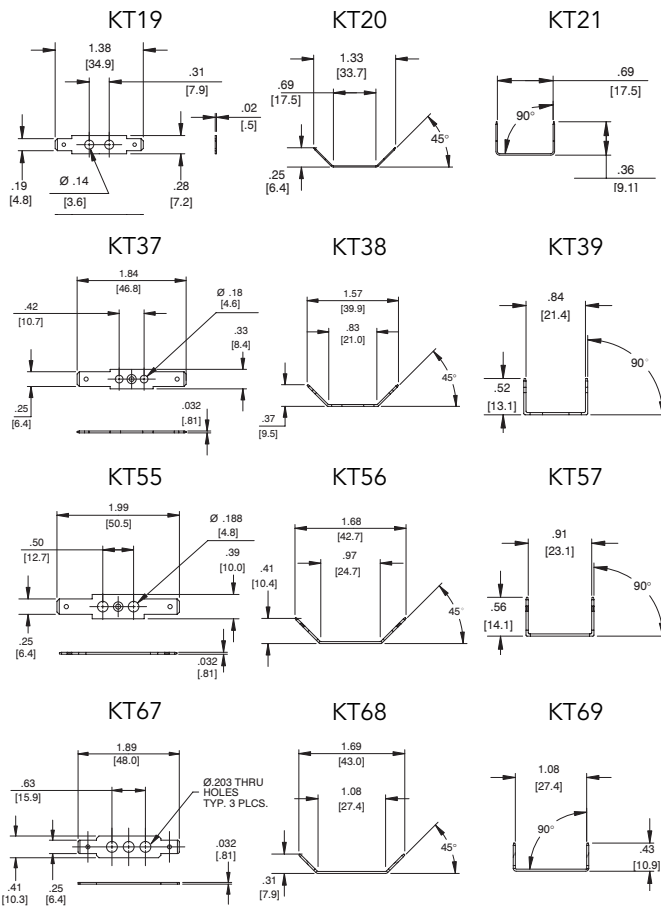

### ONE SIDE TABS

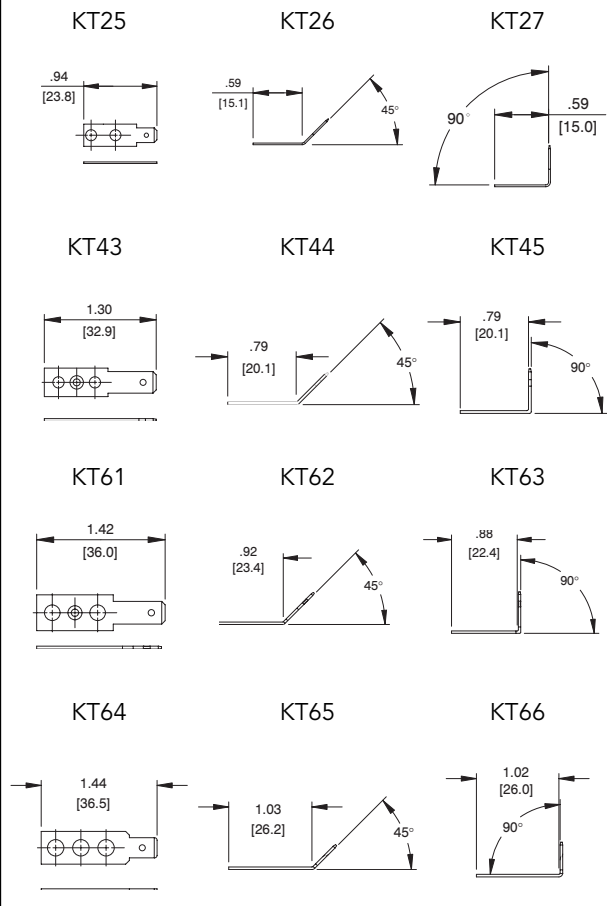

# Terminal Block Accessories

## J & JS Jumpers

Catalog #	A	B	C	D	E	F	G	H	J	K
J 410/J 411	0.41	0.25	0.19	0.09	0.10	0.04	0.010	0.094	0.08	NA
J 600	0.62	0.38	0.25	0.12	0.16	0.04	0.015	0.156	0.08	NA
J 601	0.71	0.45	0.31	0.15	0.19	0.06	0.015	0.166	0.11	NA
J 602	0.91	0.56	0.37	0.18	0.27	0.08	0.015	0.190	0.16	NA
J 603	1.13	0.69	0.43	0.21	0.25	0.12	0.031	0.201	0.24	NA
J 604	1.38	0.88	0.50	0.25	0.35	0.15	0.035	0.234	0.32	NA
J 605	1.75	1.13	0.62	0.31	0.39	0.24	0.035	0.266	0.54	NA
J 621	0.69	0.44	0.30	0.17	0.38	0.07	0.015	0.141	0.11	0.14
JS 600	0.62	0.38	0.25	0.12	0.16	0.04	0.015	0.156	0.08	0.16
JS 601	0.71	0.45	0.31	0.15	0.19	0.06	0.015	0.166	0.11	0.17
JS 602	0.91	0.56	0.37	0.18	0.27	0.08	0.015	0.190	0.16	0.14

MSP Catalog Designations:

J 600 = LL 100  
J 601 = LL 200  
J 602 = LL 300  
J 603 = LL 400

J Type Jumper

Material: Brass  
Finish: Nickel Plate

JS Type Jumper  
(per 55164/28B)

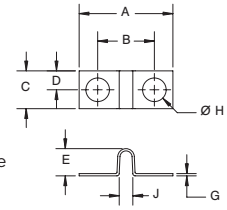

mm = dim X 25.4

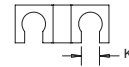

NOTE 1: These parts are not necessarily supplied flat. The functioning of the part, however, will not be interfered.

NOTE 2: All dimensions are applicable after the bus (jumper) is torqued down into the associate terminal board.

## RJ Type Jumpers

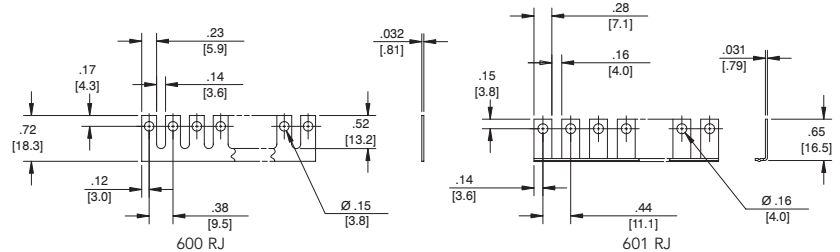

Material: Brass  
Finish: Nickel Plate

Max # of sections = 24  
Note: 670A RZ, 599 Series, use 600 RJ

Max # of sections = 24

## RJS Type Jumpers

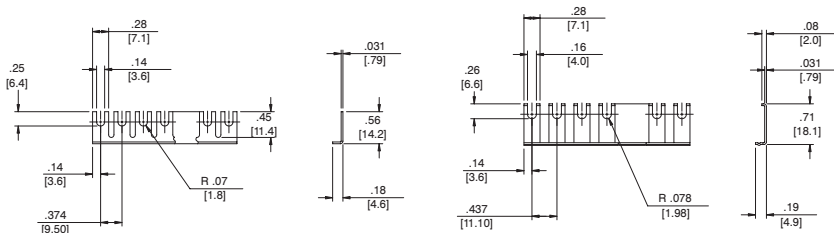

Material: Brass  
Finish: Nickel Plate

Max # of sections = 24  
Note: 670A RZ, 599 Series, use 600 RJ

Max # of sections = 24

## Wire Clamp

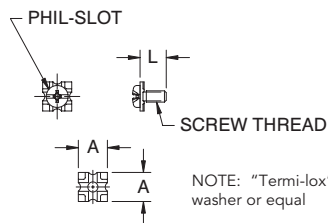

NOTE: "Termi-lox" washer or equal

Catalog #	Material	Finish	Screw Thread	L	A
3786	Steel	Nickel	8-32 UNC	0.38	0.41
3765			6-32 UNC	0.31	0.33
3780	Brass	Nickel	8-32 UNC	0.38	0.41
3760			6-32 UNC	0.31	0.33
3860	Brass	Nickel	6-32 UNC	0.30	0.29
3865	Steel	Nickel	6-32 UNC	0.30	0.29

mm = dim X 25.4

## Straddle Plate

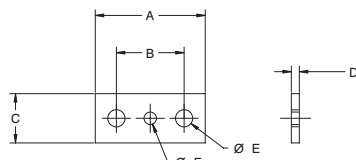

Catalog #	A	B	C	D	E	F	Material	Finish
SPB 600	0.56	0.31	0.30	0.032	0.144	N/A	Brass	Tin
SPB 601	0.71	0.42	0.30	0.031	0.148	N/A	Brass	Nickel
SPB 602	0.87	0.50	0.40	0.032	0.189	N/A	Brass	Nickel
SPB 603	1.03	0.62	0.45	0.063	0.190	0.143	Brass	Tin
SPB 604	1.21	0.75	0.54	0.087	0.187	0.138	Brass	Tin
SPB 605	1.46	0.87	0.63	0.116	0.220	0.138	Brass	Nickel

mm = dim X 25.4

BARRIER TERMINAL BLOCKS

# Terminal Block Accessories

## Stud and Turret Terminal Blocks

### Threaded Stud

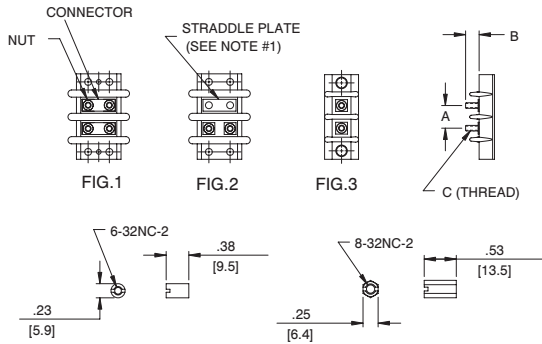

NOTE 1: Standard with block, but packed separately  
NOTE 2: 604 and 605 nuts are part of the assembly.  
Additional nuts (one per stud) are supplied in bulk. XX = # of terminals

Catalog #	Figure #	A	B	C
599 GP 2002 XX	FIG 3	0.38	0.34	6-32 NC
600A GP 2002 XX	FIG 2	0.38	0.38	6-32 NC
601 GP 2102 XX	FIG 2	0.44	0.44	6-32 NC
602 GP 2202 XX	FIG 2	0.56	0.50	8-32 NC
603 GP 2302 XX	FIG 1	0.69	0.50	10-32 NF
604 GP 2402 XX	FIG 1	0.88	0.44	10-32 NF
605 GP 2502 XX	FIG 1	1.13	0.75	1/4-28 NF
699 GP 2102 XX	FIG 3	0.44	0.44	6-32 NC
812 GP 2202 XX	FIG 3	0.56	0.50	8-32 NC

### Screw Terminal with Feed-Through Solder Terminal

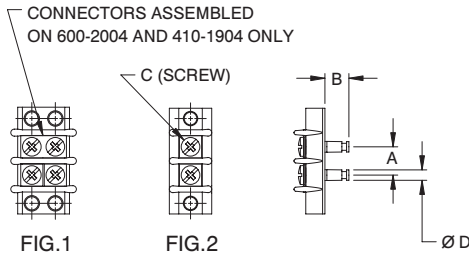

Catalog #	Figure #	A	B	C	D
411 GP 1904 XX	FIG 2	0.25	0.28	2-56 NC X .19	0.11
599 GP 2004 XX	FIG 2	0.38	0.31	5-40 NC X .25	0.14
600 GP 2004 XX	FIG 1	0.38	0.31	5-40 NC X .25	0.14
601 GP 2104 XX	FIG 1	0.44	0.38	6-32 NC X .25	0.13
699 GP 2104 XX	FIG 2	0.44	0.38	6-32 NC X .25	0.13
812 GP 2204 XX	FIG 2	0.56	0.44	8-32 NC X .25	0.14

To ensure solderability, use within six (6) months. XX = # of terminals

### Screw Terminal with Solder Pin for Printed Circuit Board Connection

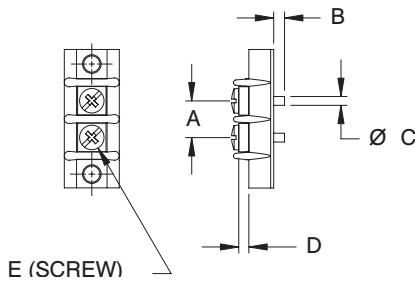

Catalog #	A	B	C	D	E
599 GP 2020 XX	0.38	0.13	0.09	0.09	5-40 NC X .19
599 GP 2021 XX	0.38	0.13	0.09	0.03	5-40 NC X .19
699 GP 2120 XX	0.44	0.19	0.09	0.04	6-32 NC X .25
699 GP 2121 XX	0.44	0.20	0.06	0.04	6-32 NC X .25

To ensure solderability, use within six (6) months. XX = # of terminals

### Individual Screw Terminals

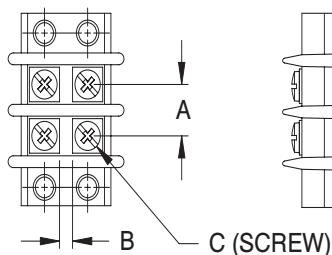

Catalog #	A	B	C
601 GP 2108 XX	0.44	0.09	6-32 NC X .25

XX = # of terminals

# Terminal Block Accessories

## Fanning Strips

- Terminals, Brass, Tin Plated
- Material: XP = Phenolic, Black  
GME = Glass Cloth Melamine  
Per MIL-M-14 Light Brown Term

## 649 Series

- For 410 and 411 Series Terminal Blocks
- Available in XP Phenolic Only

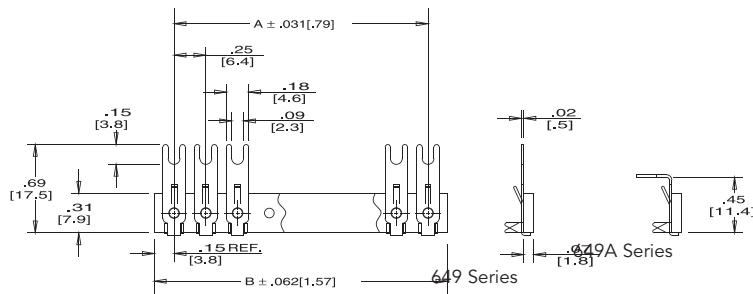

# of Term.	A	B	# of Term.	A	B
2	0.250	0.562	13	3.000	3.312
3	0.500	0.812	14	3.250	3.562
4	0.750	1.062	15	3.500	3.812
5	1.000	1.312	16	3.750	4.062
6	1.250	1.562	17	4.000	4.312
7	1.500	1.812	18	4.250	4.562
8	1.750	2.062	19	4.500	4.812
9	2.000	2.312	20	4.750	5.062
10	2.250	2.562	21	5.000	5.312
11	2.500	2.812	22	5.250	5.562
12	2.750	3.062			

## 650/651/652 Series

- 650 Series for 599, 600, and 670A RZ Series Terminal Blocks
- 651 Series for 601 and 699 Series Terminal Blocks
- 652 Series for 602 and 812 Series Terminal Blocks

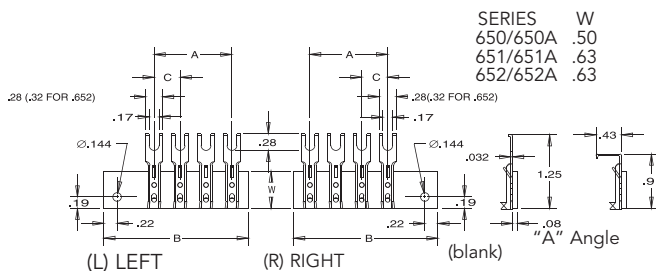

SERIES	650 / 650A	651 / 651A	652 / 652A			
C	3/8 (.375)	7/16 (.4375)	9/16 (.5625)			
# of Term.	A	B	A	B	A	B
2	.375	1.435	.437	1.497	.562	1.622
3	.750	1.810	.875	1.935	1.125	2.185
4	1.125	2.185	1.312	2.372	1.687	2.747
5	1.500	2.560	1.750	2.610	2.250	3.310
6	1.875	2.935	2.187	3.247	2.812	3.872
7	2.250	3.310	2.625	3.685	3.375	4.435
8	2.265	3.685	3.062	4.122	3.937	4.997
9	3.000	4.060	3.500	4.560	4.500	5.560
10	3.375	4.435	3.937	4.997	5.062	6.122
11	3.750	4.810	4.375	5.435	5.625	6.685
12	4.125	5.165	4.812	5.872	6.187	7.247
13	4.500	5.560	5.250	6.310	6.750	7.810
14	4.875	5.935	5.687	6.747	7.312	8.372
15	5.250	6.310	6.125	7.185	7.875	8.935
16	5.625	6.685	6.562	7.622	8.437	9.497
17	6.000	7.060	7.000	8.060	9.000	10.060
18	6.375	7.435	7.437	8.497	9.562	10.622
19	6.750	7.810	7.875	8.935	10.125	11.185
20	7.125	8.186	8.312	9.372	10.687	11.747
21	7.500	8.560	8.750	9.810	11.250	12.310
22	7.875	8.935	9.187	10.247	11.812	12.872
23	--	--	9.625	10.685	12.375	13.435
24	--	--	--	--	12.937	13.997
25	--	--	--	--	13.500	14.560
26	--	--	--	--	14.062	15.122

## Ordering Code

For convenience and accuracy in ordering, please specify catalog numbers as shown:

- For Marking Strips, use an "MS" prefix on the series
- For Insulator Strips, use an "IS" prefix on the series

Series	Mat. Code	Angle	Position	# of Terminals
652	XP	A	L	5
651	GME	(or blank)	R	
650			(or Blank)	
649				

BARRIER  
TERMINAL BLOCKS

# Terminal Block Accessories

## Solder Terminal Lugs

### ST and 3/4 ST Types

	Figure	A	B	C	D	E	F	G	H	J	M	N	R	T	
411 ST	See Figure 1														Also used on:
411 3/4ST	See Figure 1A														
599 3/4ST	FIG 2	0.56	--	--	--	0.28	0.16	0.06	0.16	0.032	0.144	0.093	0.11	--	2590, 2590A
600 ST	FIG 3	1.22	0.75	0.69	0.31	0.28	0.16	0.06	0.16	0.032	0.144	0.093	--	--	600A, 670A GP
600 3/4ST	FIG 3A	0.92	--	--	0.31	0.28	0.16	0.06	0.16	0.032	0.144	0.093	0.15	--	
601 ST	FIG 3	1.58	0.94	0.84	0.42	0.31	0.21	0.06	0.21	0.036	0.148	0.125	--	--	621 RZ
601 3/4ST	FIG 3A	1.17	--	--	0.42	0.31	0.21	0.06	0.21	0.036	0.148	0.125	0.17	--	
602 ST	FIG 3	1.85	1.06	0.94	0.50	0.41	0.28	0.09	0.28	0.036	0.177	0.125	--	--	672 GP
602 3/4ST	FIG 3A	1.37	--	--	0.50	0.41	0.28	0.09	0.28	0.036	0.177	0.125	0.20	--	
699 3/4ST	FIG 2	0.70	--	--	--	0.31	0.21	0.06	0.21	0.032	0.146	0.125	0.13	--	1690, 2690
812 3/4ST	FIG 2	0.88	--	--	--	0.41	0.28	0.09	0.28	0.037	0.177	0.125	0.19	--	

mm = dim x 25.4

MSP Catalog Designations: ST = S 3/4ST = HS

To ensure solderability, use within six (6) months.

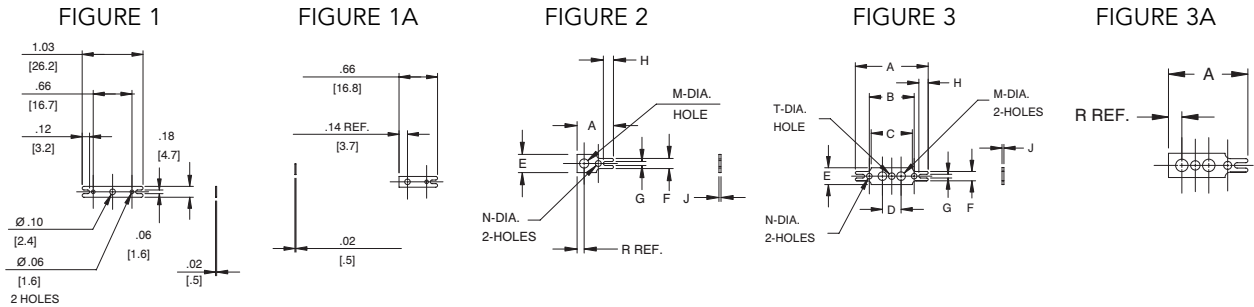

### Y, YSY and Z Types (Material: Brass Finish Electro-Tin Plated)

	Figure	A	B	C	D	E	F	H	J	M	L (see detail R)	Also used On:	
599Z, 600Y	FIG 6	0.28	0.48	0.33	0.085	0.63	0.036	NA	0.144	NA	599Z=0.31, 600Y=0.31	670A RZ	
600YSY	FIG 6	0.28	0.48	0.33	0.085	0.82	0.036	NA	0.144	NA	0.50	670A RZ	
600Z	FIG 7	0.28	0.73	0.25	0.140	0.94	0.036	0.31	0.160	0.143	0.62	670A RZ	
699Z, 601Y	FIG 4	0.31	0.63	0.44	0.099	0.80	0.036	NA	0.148	NA	699Z=0.42, 601Y=0.42		
601YSY	FIG 5	0.31	0.63	0.44	0.099	1.07	0.040	NA	0.148	NA	0.69		
602Y	FIG 4	0.43	0.75	0.52	0.125	0.95	0.040	NA	0.177	NA	0.49		
812Z, 602YSY	FIG 5	0.40	0.70	0.52	0.125	1.13	0.040	NA	0.177	NA	812Z=0.64, 602YSY=0.67		
602Z	FIG 8	0.40	1.09	0.38	0.203	1.06	0.040	0.50	0.177	NA	0.60		
603Y	FIG 9	NOTE: For factory assembly only onto 603 Terminal Boards										0.60	
672 YSY	FIG 7	0.42	0.70	0.27	0.08	1.02	0.040	0.25	NA	0.14	0.56	300 series	

mm = dim x 25.4

MSP Catalog Designations: Y = L YSY = LSL

To ensure solderability, use within six (6) months.

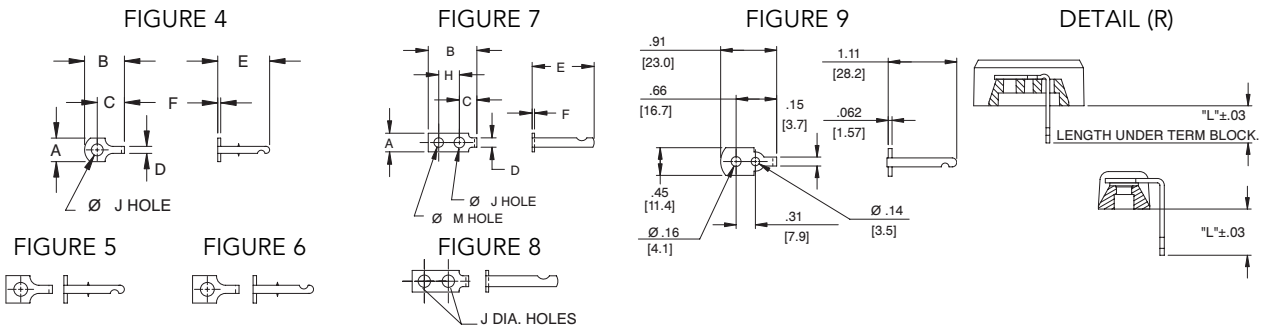

Figures 5 & 6 same as Figure 4 except as shown

Same as Figure 7 except as shown

BARRIER  
TERMINAL BLOCKS