



Main

Range of product	OsiSense XS
Series name	General purpose
Sensor type	Inductive proximity sensor
Wiring configuration	2-wire
Output circuit type	AC/DC
Protection type	Short-circuit protection multi voltage
Device application	2-wire DC short-circuit protection
Sensor name	XS1
Sensor design	Cylindrical M18
Size	60 mm
Body type	Fixed
Detector flush mounting acceptance	Flush mountable
Material	Metal
Type of output signal	Discrete
Wiring technique	2-wire
[Sn] nominal sensing distance	0.20 in (5 mm)
Discrete output function	1 NO
Electrical connection	Cable
Cable length	6.56 ft (2 m)
[Us] rated supply voltage	24...210 V DC 24...240 V AC 50/60 Hz
Switching capacity in mA	5...300 mA AC overload and short-circuit protection 5...200 mA DC overload and short-circuit protection
IP degree of protection	IP68 double insulation IEC 60529

Complementary

Thread type	M18 x 1
Detection face	Frontal
Front material	PPS
Enclosure material	Nickel Plated Brass
Operating zone	0.00...0.16 in (0...4 mm)
Differential travel	1...15% of Sr
Cable composition	2 x 0.34 mm ²
Wire insulation material	PvR
Status LED	Output state 1 LED yellow) Supply on 1 LED green)
Maximum residual current	1.5 mA open state
Switching frequency	<= 2000 Hz DC <= 25 Hz AC
Maximum voltage drop	<5.5 V closed state)
Maximum delay first up	70 ms
Maximum delay response	2 ms
Maximum delay recovery	4 ms
Marking	CE
Threaded length	2.01 in (51 mm)

Length	2.36 in (60 mm)
Net Weight	0.26 lb(US) (0.12 kg)

Environment

Product certifications	UL CSA CCC
Ambient air temperature for operation	-13...158 °F (-25...70 °C)
Ambient air temperature for storage	-40...185 °F (-40...85 °C)
Vibration resistance	25 gn +/- 2 mm 10...55 Hz)IEC 60068-2-6
Shock resistance	50 gn 11 ms IEC 60068-2-7

Ordering and shipping details

Category	22486 - SENSORS, PROXIMITY
Discount Schedule	DS2
GTIN	00785901915669
Nbr. of units in pkg.	1
Package weight(Lbs)	0.27 lb(US) (0.12 kg)
Returnability	Yes
Country of origin	FR

Packing Units

Unit Type of Package 1	PCE
Package 1 Height	1.61 in (4.1 cm)
Package 1 width	3.74 in (9.5 cm)
Package 1 Length	5.31 in (13.5 cm)
Unit Type of Package 2	BAG
Number of Units in Package 2	1
Package 2 Weight	4.34 oz (123 g)
Package 2 Height	1.18 in (3 cm)
Package 2 width	7.87 in (20 cm)
Package 2 Length	5.91 in (15 cm)
Unit Type of Package 3	S03
Number of Units in Package 3	44
Package 3 Weight	13.04 lb(US) (5.916 kg)
Package 3 Height	11.81 in (30 cm)
Package 3 width	11.81 in (30 cm)
Package 3 Length	15.75 in (40 cm)

Offer Sustainability

Sustainable offer status	Green Premium product
California proposition 65	WARNING: This product can expose you to chemicals including: Diisononyl phthalate (DINP), which is known to the State of California to cause cancer, and Di-isodecyl phthalate (DIDP), which is known to the State of California to cause birth defects or other reproductive harm. For more information go to www.P65Warnings.ca.gov
REACH Regulation	REACH Declaration
EU RoHS Directive	Pro-active compliance (Product out of EU RoHS legal scope) EU RoHS Declaration
Mercury free	Yes
RoHS exemption information	Yes
Environmental Disclosure	Product Environmental Profile
Circularity Profile	End Of Life Information

Contractual warranty

Warranty	18 months
----------	-----------

Dimensions

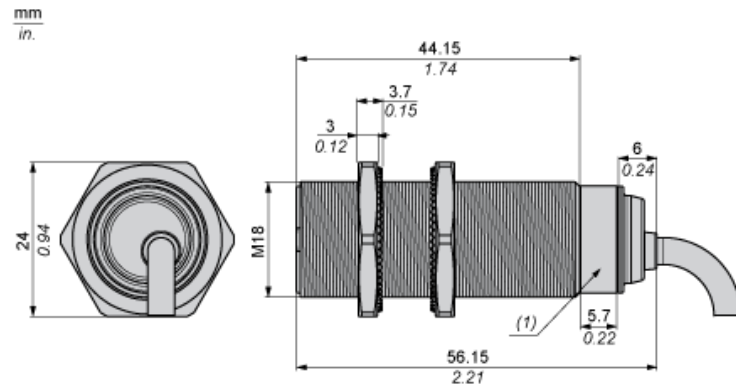

Minimum Mounting Distances

Side by side

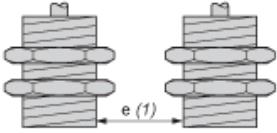

e (1) 10 mm/0.39 in.

≥

Face to face

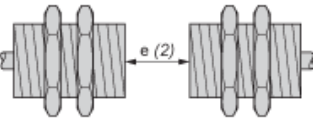

e (2) 60 mm/2.36 in.

≥

Facing a metal object

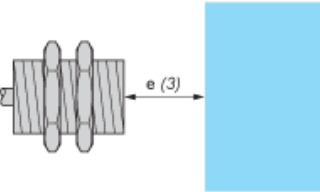

e (3) 15 mm/0.60 in.

≥

Mounting

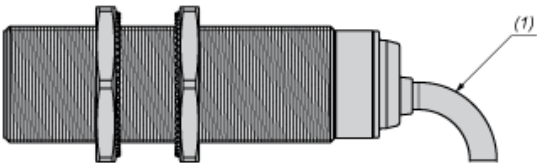

(1) Bending cable: 4 x external cable diameter

Wiring Schemes

2-Wire AC or DC

NO output

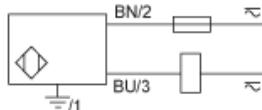

BU : Blue
BN : Brown

Performance Curves

Standard Steel Target : 18x18x1 mm

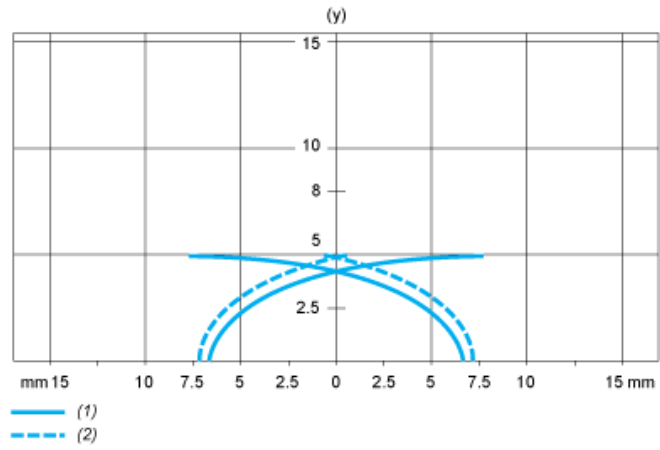

- (1) Pick-up points
- (2) Drop-out points (object approaching from the side)
- (y) Sensing distance in mm