

## SS17HB-R03300

Aliases (UAL17HBR033000)

Not for New Design

Common Mode Chokes - Power, KEMET, SS17HB, Through-Hole Bobbin, Common Mode, 0.03 H

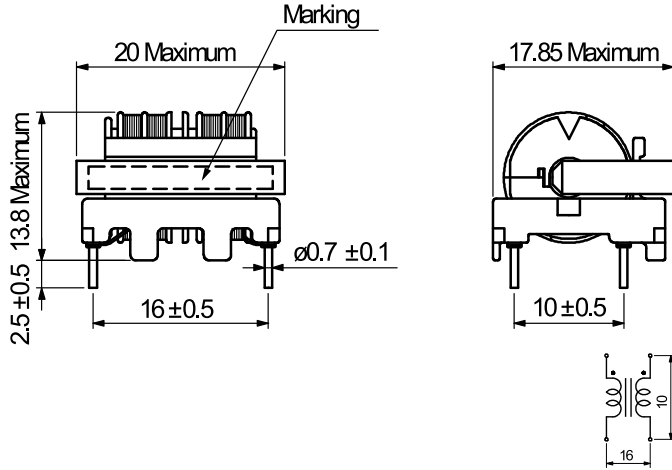

### General Information

Series	SS17HB
Style	Through-Hole Bobbin
RoHS	Yes
Miscellaneous	Inductance Measurement Condition: 1kHz 1V KC530 or equivalent.

### Dimensions

L	20mm MAX
T	17.85mm MAX
H	13.8mm MAX
LL	2.5mm +/-0.5mm
S	16mm +/-0.5mm
S1	10mm +/-0.5mm
Wire Size	0.2mm
F	0.7mm +/-0.1mm

### Specifications

Voltage AC	250 VAC
Inductance	30 mH
Rated Current	300 mA
Temperature Range	-25/+120°C
DC Resistance	2.6 Ohms

### Packaging Specifications

Typical Component Weight	5.9 g
--------------------------	-------

Statements of suitability for certain applications are based on our knowledge of typical operating conditions for such applications, but are not intended to constitute - and we specifically disclaim - any warranty concerning suitability for a specific customer application or use. This Information is intended for use only by customers who have the requisite experience and capability to determine the correct products for their application. Any technical advice inferred from this Information or otherwise provided by us with reference to the use of our products is given gratis, and we assume no obligation or liability for the advice given or results obtained.