

**12 W and 36 W Low profile Modular DC Power Supplies for electrical cabinets**

**Type 78.12....2400**

- Output 24 V DC, 12 W
- 17.5 mm (1 module) x 61 mm deep

**Type 78.12....1200**

- Output 12 V DC, 12 W
- 17.5 mm (1 module) x 61 mm deep

**Type 78.36**

- Output 24 V DC, 36 W
- Input fuse: Easily replaceable plus spare
- 70 mm (4-module) wide x 61 mm deep
- Low (< 0.4 W) stand-by power consumption
- Thermal protection: internal, with V<sub>out</sub> shutdown - power OFF to reset
- Short circuit protection: Hiccup (auto-recovery) mode
- Overvoltage protection: Varistor
- Flyback topology
- Compliant with EN 60950-1 and EN 61204-3
- Parallel working for automatic redundancy - with OR diodes
- Dual Polarity and Series connection permissible
- 35 mm rail (EN 60715) mount

Screw terminal



For outline drawing see page 17

**Output specification**

Output current (-20...+40 °C, 230 V AC input)	A	0.63	1.25	1.7
Rated current I <sub>N</sub> (50 °C, full input operating range)	A	0.50	1	1.5
Rated voltage	V	24	12	24
Rated power	W	12	12	36
Output power (-20...+40 °C, 230 V AC input)	W	15	15	40
Peak current capability for 3 ms*	A	2	3	8
Output voltage adjust	V	—	—	—
Voltage variation (from no-load to full-load)		< 1%	< 1%	< 1%
Voltage ripple @ full load**	mV	< 200	< 200	< 200
Hold-up time @ full load:	with 100 V AC input	> 10	> 10	> 20
	with 260 V AC input	> 90	> 90	> 100

**Input specification**

Nominal voltage (U <sub>N</sub> )	V AC (50/60 Hz)	110...240	110...240	110...240
	V DC (not polarized)	220	220	220
Operating range	V AC (50/60 Hz)	100...265***	100...265***	100...265***
	V DC	140...370	140...370	140...370
Max power consumption (@ 100 V AC, 50 Hz)	VA	28.2	32	57.5
	W	14.2	17.2	43
Stand-by power consumption	W	< 0.4	< 0.4	< 0.4
Power factor		0.50	0.53	0.74
Max current consumption (@ 88 V AC)	A	0.25	0.30	0.6
Max. inrush current (peak @ 265 V) for 3 ms	A	10	10	12
Replaceable input fuse		—	—	1 A - T

**Technical data**

Efficiency (@ 230 V AC)	%	85	87	86
MTTF	h	> 400 · 10 <sup>3</sup>	> 400 · 10 <sup>3</sup>	> 600 · 10 <sup>3</sup>
Start-up delay	s	< 1	< 1	< 1
Dielectric strength between input/output	V AC	2500 (class II)	2500 (class II)	3000 (class II)
Dielectric strength between input/PE	V AC	—	—	—
Ambient temperature range****	°C	-20...+60	-20...+60	-20...+70
Protection category		IP 20	IP 20	IP 20

**Approvals** (according to type)



**78.12....2400**



• 24 V DC, 12 W output

**78.12....1200**



• 12 V DC, 12 W output

**78.36**



• 24 V DC, 36 W output

Replaceable fuse + spare



\* (see diagrams P78)  
\*\* peak to peak, 100 Hz component, with 100 V AC input  
\*\*\* 88...100 V AC with output current limited to 80% I<sub>N</sub>  
\*\*\*\* (see derating diagrams L78)

**F**

**60 W and 50 W High efficiency, low profile  
Modular DC Power Supplies for electrical  
cabinets**
**Type 78.60**

- Output 24 V DC, 60 W

**Type 78.50**

- Output 12 V DC, 50 W

- High efficiency (up to 91%)
- Low (< 0.4 W) stand-by power consumption
- Thermal protection: internal, with  $V_{out}$  shutdown - power OFF to reset
- Short circuit protection: Hiccup (auto-recovery) mode
- Input fuse: Easily replaceable plus spare
- Overvoltage protection: Varistor
- Flyback topology
- ZVS (Zero-voltage-switching), quasi-resonant mode switching
- Compliant with EN 60950-1 and EN 61204-3
- Parallel working for automatic redundancy - with OR diodes
- Dual Polarity and Series connection permissible
- Small dimensions: 70 mm (4-modules) wide, 61 mm deep
- 35 mm rail (EN 60715) mount

Screw terminal



For outline drawing see page 17

**F**
**Output specification**

Output current (-20...+40 °C, 230 V AC input)	A	2.8	4.6
Rated current $I_N$ (50 °C, full input operating range)	A	2.5	4.2
Rated voltage	V	24	12
Rated power	W	60	50
Output power (-20...+40 °C, 230 V AC input)	W	68	55
Peak current capability for 3 ms*	A	10	12
Output voltage adjust	V	24...28	12...15
Voltage variation (from no-load to full-load)		< 1%	< 1%
Voltage ripple @ full load**	mV	< 200	< 200
Hold-up time @ full load: with 100 V AC input ms		> 20	> 30
with 260 V AC input ms		> 130	> 150

**Input specification**

Nominal voltage ( $U_N$ )	V AC (50/60 Hz)	110...240	110...240
	V DC (not polarized)	220	220
Operating range	V AC (50/60 Hz)	88...265	88...265
	V DC	140...370	140...370
Max power consumption (@ 100 V AC, 50 Hz)	VA	90	89
	W	67.5	58.3
Stand-by power consumption	W	< 0.4	< 0.4
Power factor		0.75	0.65
Max current consumption (@ 88 V AC)	A	0.9	0.85
Max. inrush current (peak @ 265 V) for 3 ms	A	30	30
Replaceable input fuse		1.6 A - T	1.6 A - T

**Technical data**

Efficiency (@ 230 V AC)	%	91	90
MTTF	h	> 500 · 10 <sup>3</sup>	> 400 · 10 <sup>3</sup>
Start-up delay	s	< 1	< 1
Dielectric strength between input/output	V AC	3000 (class II)	3000 (class II)
Dielectric strength between input/PE	V AC	1500 (class I)	1500 (class I)
Ambient temperature range***	°C	-20...+70	-20...+70
Protection category		IP 20	IP 20

**Approvals** (according to type)

CE EAC

**78.60**

- 24 V DC, 60 W output
- Output adjustable between 24-28 V
- ZVS technology

**78.50**

- 12 V DC, 50 W output
- Output adjustable between 12-15 V
- ZVS technology

Replaceable fuse + spare



\* (see diagrams P78)

\*\* peak to peak, 100 Hz component, with 100 V AC input

\*\*\* (see derating diagrams L78)

**60 W and 50 W High efficiency, low profile Modular DC Power Supplies for electrical cabinets**

**Fold-Back overload characteristics for Battery charging applications and parallel working for increased load current**

**Type 78.61**

- Output 24 V DC, 60 W

**Type 78.51**

- Output 12 V DC, 50 W

- High efficiency (up to 91%)
- Low (< 0.4 W) stand-by power consumption
- Thermal protection: internal, with V<sub>out</sub> shutdown - power OFF to reset
- Short circuit protection: Hiccup (auto-recovery) mode
- Overload protection: Fold-back mode
- Input fuse: Easily replaceable plus spare
- Overvoltage protection: Varistor
- Flyback topology
- ZVS (Zero-voltage-switching), quasi-resonant mode switching
- Compliant with EN 60950-1 and EN 61204-3
- Parallel working for increased load current (with OR diodes)
- Dual Polarity and Series connection permissible
- Small dimensions: 70 mm (4-modules) wide, 60 mm deep
- 35 mm rail (EN 60715) mount

Screw terminal



For outline drawing see page 17

**Output specification**

Output current (-20...+40 °C, 230 V AC input)	A	2.6	4.6
Rated current I <sub>N</sub> (50 °C, full input operating range)	A	2.5	4.2
Rated voltage	V	24	12
Rated power	W	60	50
Output power (-20...+40 °C, 230 V AC input)	W	68	55
Peak current capability for 3 ms*	A	8	12
Output voltage adjust	V	24...28	12...15
Voltage variation (from no-load to full-load)		< 1%	< 1%
Voltage ripple @ full load**	mV	< 200	< 200
Hold-up time @ full load:	with 100 V AC input ms	> 20	> 30
	with 260 V AC input ms	> 130	> 150

**Input specification**

Nominal voltage (U <sub>N</sub> )	V AC (50/60 Hz)	110...240	110...240
	V DC (not polarized)	220	220
Operating range	V AC (50/60 Hz)	88...265	88...265
	V DC	140...370	140...370
Max power consumption (@ 100 V AC, 50 Hz)	VA	90	89
	W	67.5	58.3
Stand-by power consumption	W	< 0.4	< 0.4
Power factor		0.75	0.65
Max current consumption (@ 88 V AC)	A	0.9	0.85
Max. inrush current (peak @ 265 V) for 3 ms	A	30	30
Replaceable input fuse		1.6 A - T	1.6 A - T

**Technical data**

Efficiency (@ 230 V AC)	%	91	90
MTTF	h	> 500 · 10 <sup>3</sup>	> 400 · 10 <sup>3</sup>
Start-up delay	s	< 1	< 1
Dielectric strength between input/output	V AC	3000 (class II)	3000 (class II)
Dielectric strength between input/PE	V AC	1500 (class I)	1500 (class I)
Ambient temperature range***	°C	-20...+70	-20...+70
Protection category		IP 20	IP 20

**Approvals** (according to type)



**NEW 78.61**

- 24 V DC, 60 W output
- Output adjustable between 24-28 V
- ZVS technology
- Suitable for battery charging

**NEW 78.51**

- 12 V DC, 50 W output
- Output adjustable between 12-15 V
- ZVS technology
- Suitable for battery charging

Replaceable fuse + spare



- \* (see diagrams P78)
- \*\* peak to peak, 100 Hz component, with 100 V AC input
- \*\*\* (see derating diagrams L78)
- suitable for battery charging (see details page 11)

**Industrial Switch Mode DC Power Supplies:  
120 W and 130 W**
**Fold-Back overload characteristics for Battery  
charging applications and parallel working  
for increased load current**
**Type 78.1C**

- Output 24 V DC, 120 W

**Type 78.1D**

- Output 24 V DC, 130 W
- Double stage active Power Factor Correction
- High efficiency (up to 90%)
- Low stand-by power consumption
- Forward topology
- Thermal protection: internal with pre-alert alarm via LED and auxiliary contact, and with  $V_{out}$  safety shutdown - power OFF to reset
- Overload indication: Pre-alert alarm via LED and auxiliary contact indication
- Boost current: Without time limit, with LED and auxiliary contact indication
- Overload protection: Fold-back mode
- Short circuit protection: Hiccup (auto-recovery) mode
- Input fuse: Easily replaceable plus spare
- Overvoltage protection: Varistor
- Compliant with EN 60950-1 and 61204-3
- Parallel working for increased load current (with OR diodes)
- Dual Polarity and Series connection permissible
- 35 mm rail (EN 60715) mount

**78.1C**

- 24 V DC, 120 W output
- Output adjustable between 24-28 V

**78.1D**

- 24 V DC, 130 W output
- Output adjustable between 24-28 V
- Double stage with active PFC (Power Factor Correction)

 Replaceable fuse  
+ spare

 Thermal protection  
with LED indication

 Auxiliary contact  
signalling

\* (see diagrams P78)

\*\* peak to peak, 100 Hz component, with 110 V AC input

\*\*\* (see derating diagrams L78)

 suitable for battery charging (see details page 11)

**F**

For outline drawing see page 17

**Output specification**

Output current (-20...+40 °C, 230 V AC input)	A	5.4	5.4
Rated current $I_N$ (50 °C, full input operating range)	A	5	5.4
Rated voltage	V	24	24
Rated power	W	120	130
Output power (-20...+40 °C, 230 V AC input)	W	130	130
Peak current capability for 5 ms*	A	15	10
Output voltage adjust	V DC	24...28	24...28
Voltage variation (from no-load to full-load)		< 1%	< 1%
Voltage ripple @ full load**	mV	< 100	< 100
Hold-up time @ full load: with 110 V AC input ms		> 10	> 20
with 260 V AC input ms		> 80	> 20

**Input specification**

Nominal voltage ( $U_N$ )	V AC (50/60 Hz)	120...240	110...240
	V DC	220	110...240
Operating range	V AC (50/60 Hz)	110...265	88...265
	V DC	155...275 (polarized)	95...275 (non-polarized)
Drop out DC Voltage	V	140 (with $I_{output} = 2.5$ A)	80
Max power consumption (@ minimum V AC operating range)	VA	195 (@ 60 Hz)	145 (@ 50 Hz)
	W	137 (@ 60 Hz)	145 (@ 50 Hz)
Stand-by power consumption	W	< 2.1	< 3.3
Power factor		0.7	0.998
Max current consumption	A	1.7 (@ 110 V AC)	1.6 (@ 88 V AC)
Max. inrush current (peak @ 265 V) for 3 ms	A	10	12
Replaceable input fuse		2.5 A - T	2.5 A - T

**Technical data**

Efficiency (@ 230 V AC)	%	90	89
MTTF	h	> 500 · 10 <sup>3</sup>	> 400 · 10 <sup>3</sup>
Start-up delay	s	< 1	< 1
Dielectric strength between input/output	V AC	2500 (class II)	2500 (class II)
Dielectric strength between input/PE	V AC	1500 (class I)	1500 (class I)
Ambient temperature range***	°C	-20...+70	-20...+70
Protection category		IP 20	IP 20

**Approvals (according to type)**

**Industrial Switch Mode DC Power Supply: 240 W**

**Overload characteristics support parallel working for increased load current**

**Type 78.2E**

- Output 24 V DC, 240 W
- Double stage active Power Factor Correction

- High efficiency (up to 93%)
- Low stand-by power consumption
- Forward topology
- Thermal protection: internal with pre-alert alarm via LED and auxiliary contact, and with V<sub>out</sub> safety shutdown - power OFF to reset
- Overload indication: Pre-alert alarm via LED and auxiliary contact indication
- Boost current: Without time limit, with LED and auxiliary contact indication
- Overload up to 20 A
- Short circuit protection: Hiccup (auto-recovery) mode
- Input fuse: Easily replaceable plus spare
- Overvoltage protection: Varistor
- Compliant with EN 60950-1 and 61204-3
- Parallel working for increased load current (with OR diodes)
- Dual Polarity and Series connection permissible
- 35 mm rail (EN 60715) mount

Screw terminal



For outline drawing see page 18

**Output specification**

Output current (-20...+40 °C, 230 V AC input)	A	10.8
Rated current I <sub>N</sub> (50 °C, full input operating range)	A	10
Rated voltage	V	24
Rated power	W	240
Output power (-20...+40 °C, 230 V AC input)	W	250
Peak current capability for 5 ms*	A	25
Output voltage adjust	V DC	24...28
Voltage variation (from no-load to full-load)		< 1%
Voltage ripple @ full load**	mV	< 100
Hold-up time @ full load: with 110 V AC input	ms	> 20
with 260 V AC input	ms	> 20

**Input specification**

Nominal voltage (U <sub>N</sub> )	V AC (50/60 Hz)	110...240
	V DC	110...240
Operating range	V AC (50/60 Hz)	88...265
	V DC	90...275 (non-polarised)
Drop out DC Voltage	V	80
Max power consumption (@ minimum V AC operating range)	VA	275 (@ 50 Hz)
	W	274 (@ 50 Hz)
Stand-by power consumption (@ 88 V)	W	≤ 2.8
Power factor		0.995
Max current consumption	A	3.0 (@ 88 V AC)
Max. inrush current (peak @ 265 V) for 3 ms	A	12
Replaceable input fuse		3.15 A - T

**Technical data**

Efficiency (@ 230 V AC)	%	93
MTTF	h	> 400 · 10 <sup>3</sup>
Start-up delay	s	< 1
Dielectric strength between input/output	V AC	2500 (class II)
Dielectric strength between input/PE	V AC	1500 (class I)
Ambient temperature range***	°C	-20...+70
Protection category		IP 20

**Approvals** (according to type)

**NEW 78.2E**



- 24 V DC, 240 W output
- Output adjustable between 24-28 V
- Double stage with active PFC (Power Factor Correction)

Replaceable fuse + spare



Thermal protection with LED indication



Auxiliary contact signalling



\* (see diagrams P78)

\*\* peak to peak, 100 Hz component, with 110 V AC input

\*\*\* (see derating diagrams L78)

## Ordering information

Example: 78 series switch mode power supply, 36 W - 24 V DC output, supply voltage 110...240 V AC, replaceable fuse.

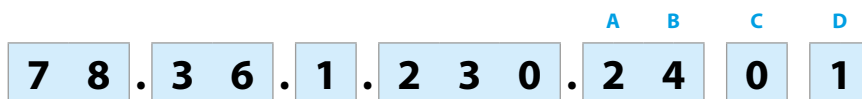

**Series**

**Power**

- 12 = 12 W output
- 36 = 36 W output
- 50/51 = 50 W output
- 60/61 = 60 W output
- 1C = 120 W output
- 1D = 130 W output
- 2E = 240 W output

**Voltage conversion**

- 1 = AC input, DC output

**Input voltage**

- 230 = 110...240 V AC

**D:**

- 0 = Standard
- 1 = Replaceable fuse
- 3 = Replaceable fuse + output voltage regulator
- 4 = Fuse + regulator + positive logic contact
- 5 = Fuse + regulator + pre-alarm contact

**C:**

- 0 = Standard
- 1 = Double stage, with PFC (Power Factor Correction)

**AB:**

- 12 = 12 V output
- 24 = 24 V output

**Codes**

- 78.12.1.230.1200
- 78.12.1.230.2400
- 78.36.1.230.2401
- 78.50.1.230.1203
- 78.51.1.230.1203
- 78.60.1.230.2403
- 78.61.1.230.2403
- 78.1C.1.230.2404
- 78.1C.1.230.2405
- 78.1D.1.230.2414
- 78.1D.1.230.2415
- 78.2E.1.230.2414
- 78.2E.1.230.2415

## Technical data

EMC specifications (according to EN 61204-3)		Reference standard	78.12, 78.36	78.60, 78.50	78.61, 78.51	78.1C, 78.1D	78.2E
Electrostatic discharge	contact discharge	EN 61000-4-2	4 kV	4 kV	4 kV	4 kV	4 kV
	air discharge	EN 61000-4-2	8 kV	8 kV	8 kV	8 kV	8 kV
Radiated electromagnetic field	80...1000 MHz	EN 61000-4-3	6 V/m	10 V/m	10 V/m	10 V/m	10 V/m
	1...2.8 GHz	EN 61000-4-3	3 V/m	3 V/m	3 V/m	3 V/m	10 V/m
Fast transients (burst 5/50 ns, 5 and 100 kHz)	on supply terminals	EN 61000-4-4	2 kV	3 kV	3 kV	3 kV	3 kV
Voltage pulses on supply terminals (surge 1.2/50 µs)	common mode	EN 61000-4-5	2 kV	2 kV	2 kV	3 kV	2.5 kV
	differential mode	EN 61000-4-5	2 kV (78.12), 4 kV* (78.36)	4 kV*	4 kV*	4 kV**	4 kV**
Radio-frequency common mode voltage (0.15...230 MHz)	on supply terminals	EN 61000-4-6	6 V	10 V	10 V	10 V	10 V
Short interruptions		EN 61000-4-11	5 cycles	6 cycles	6 cycles	6 cycles	5 cycles
Radio-frequency conducted emissions	0.15...30 MHz	EN 55022	class B	class A	class B	class B	class B
Radiated emissions	30...1000 MHz	EN 55022	class B	class A	class B	class A	class A
<b>Terminals</b>			<b>Max</b>			<b>Max...Min</b>	
Wire size (Solid cable, stranded cable)	mm <sup>2</sup>		1 x 4 / 2 x 2.5			1 x 4...1 x 0.5	
	AWG		1 x 12 / 2 x 14			1 x 12...1 x 20	
Screw torque	Nm		0.8			0.5	
Wire strip length	mm		9			9	
<b>Other data</b>							
Power lost to the environment with rated output current	W		2 (78.12), 5 (78.36, 78.50/51), 5.4 (78.60/61)				
	W		12 (78.1C), 13.2 (78.1D), 16.8 (78.2E)				

\* input fuse may blow for surges higher than 1.5 kV

\*\* input fuse may blow for surges higher than 2 kV

## Output specification

L78-1 Output current v ambient temperature (78.12)

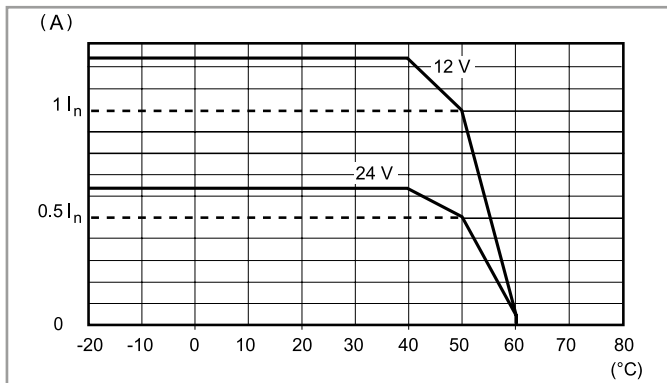

P78-1 Output peak current v time (78.12)

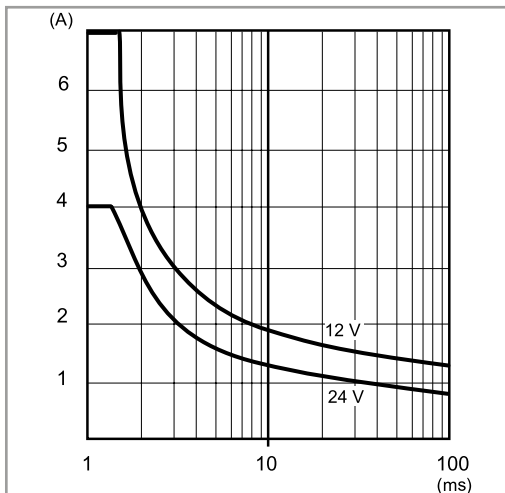

L78-2 Output current v ambient temperature (78.36)

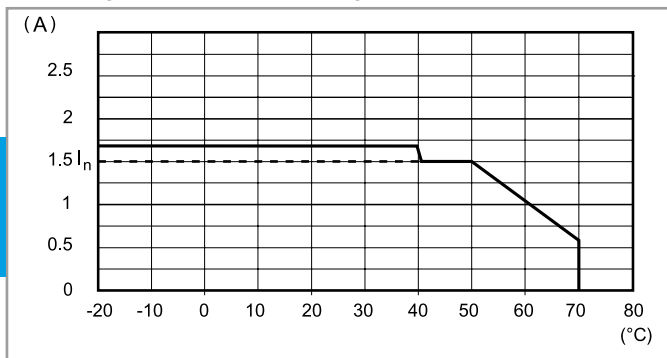

P78-2 Output peak current v time (78.36)

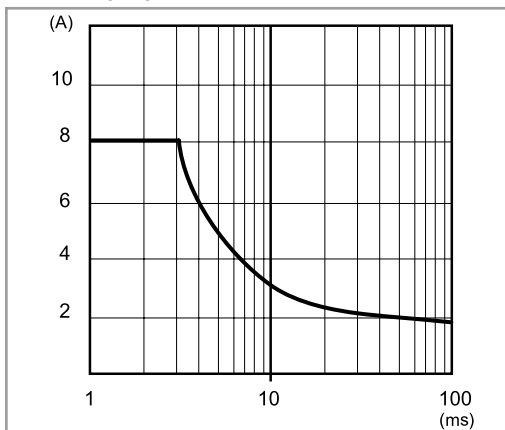

L78-3 Output current v ambient temperature (78.60)

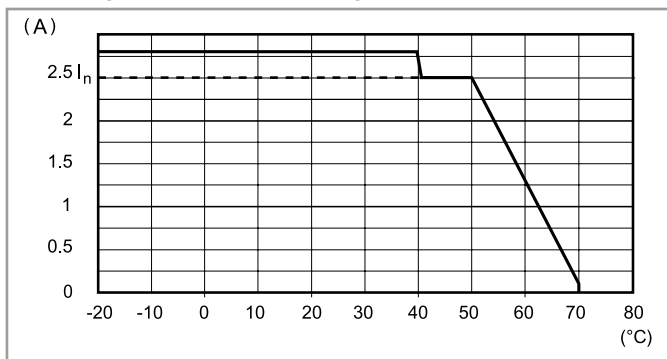

P78-3 Output peak current v time (78.60)

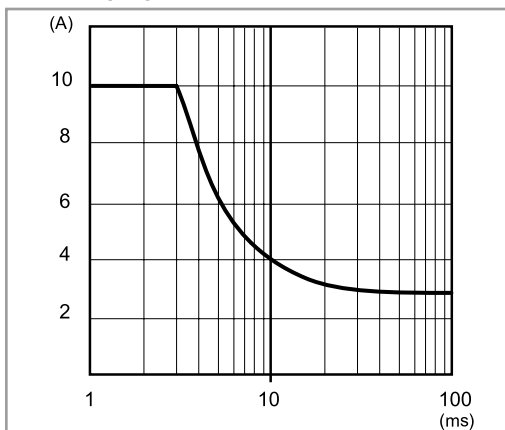

L78-4 Output current v ambient temperature (78.50/51)

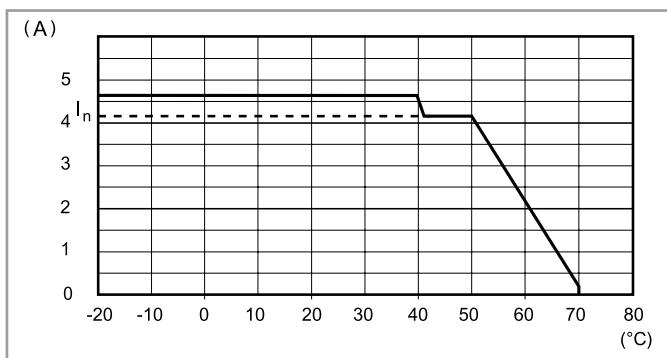

P78-4 Output peak current v time (78.50/51)

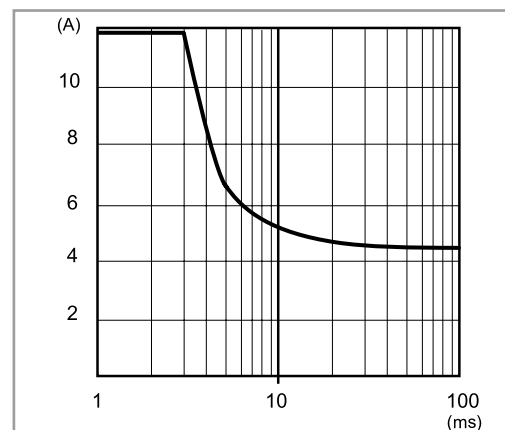

F

**Output specification**

**L78-5 Output current v ambient temperature (78.61)**

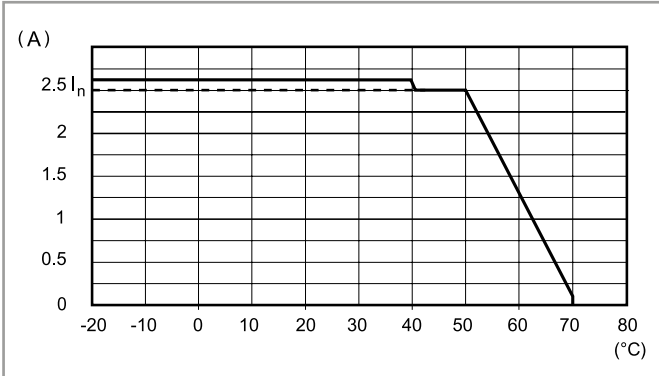

**P78-5 Output peak current v time (78.61)**

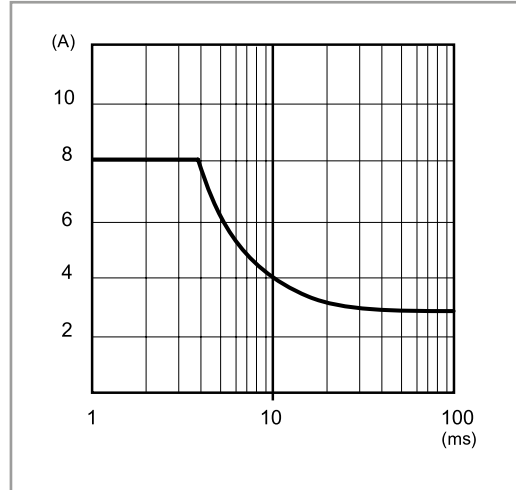

**L78-5 Output current v ambient temperature (78.1C)**

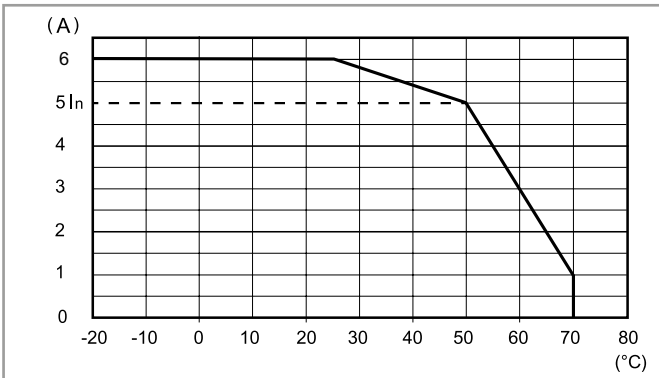

**P78-5 Output peak current v time (78.1C)**

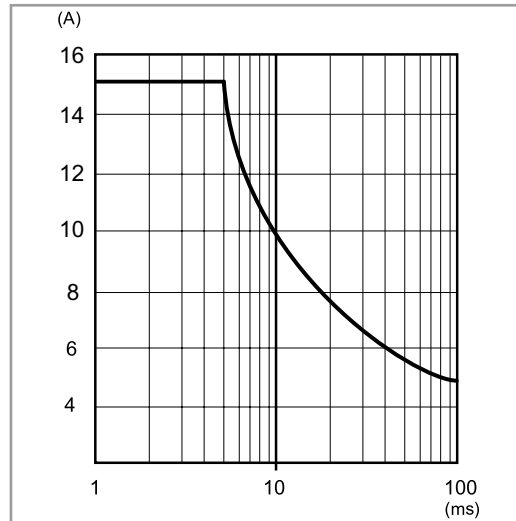

**L78-6 Output current v ambient temperature (78.1D)**

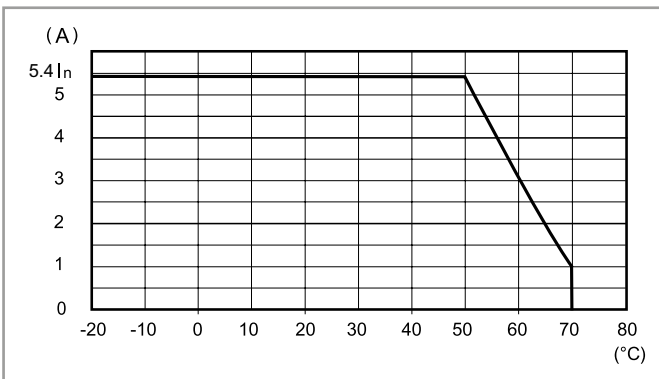

**P78-6 Output peak current v time (78.1D)**

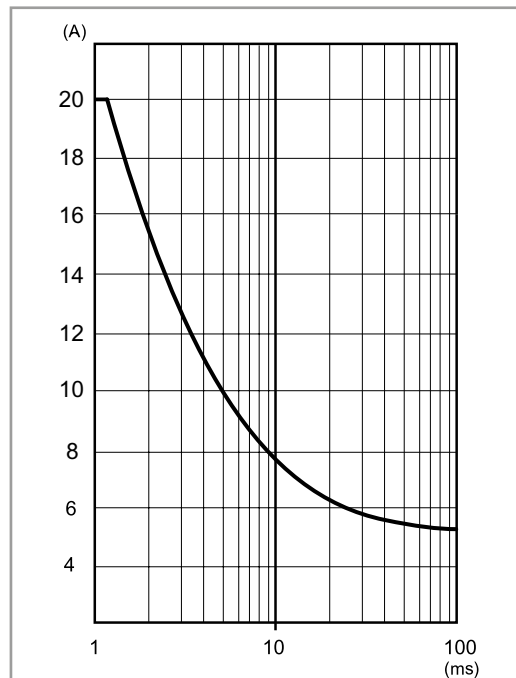

**F**

## Output specification

L782E-1 Output current v ambient temperature (78.2E)

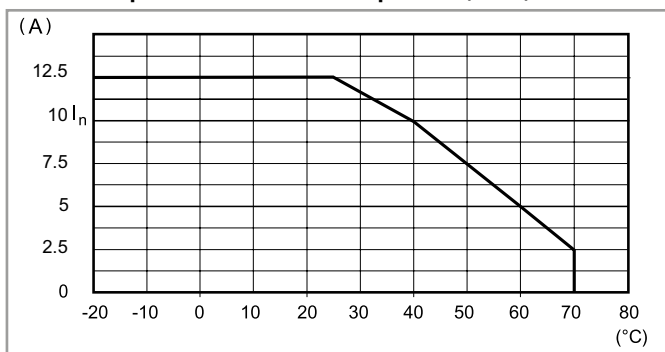

P782E-1 Output peak current v time (78.2E)

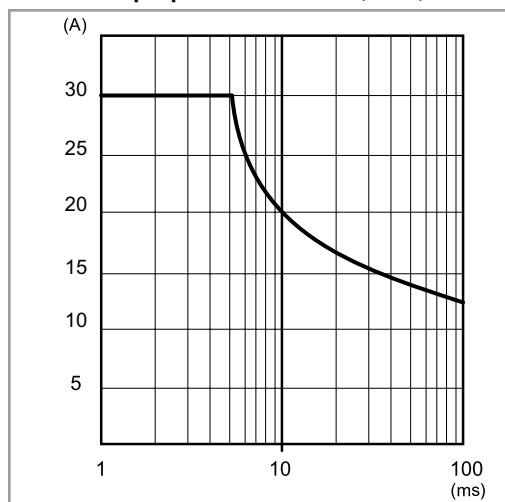

## Hiccup mode

F

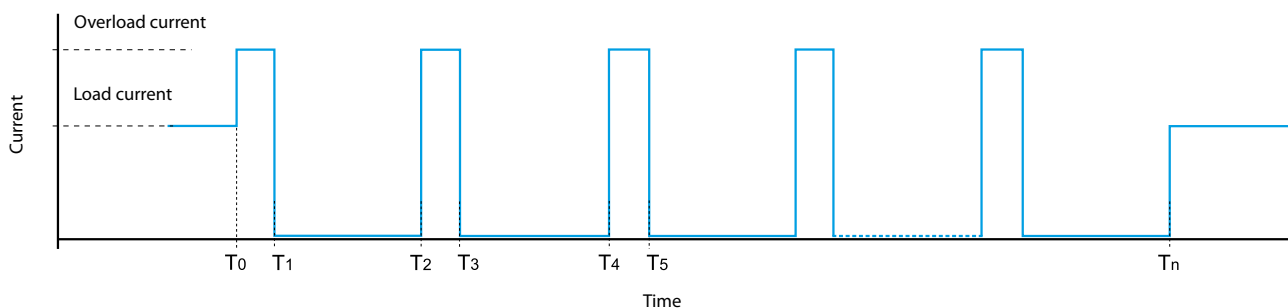

Under normal conditions, the 78 Series Power Supply supplies the current required by the load.

However, under abnormal conditions such as a short circuit or heavy overload ( $T_0$ ) the output voltage will be rapidly reduced to zero - followed by the current ( $T_1$ ). After approximately 2 seconds ( $T_1$  to  $T_2$ ), the power supply checks for the persistence of the anomaly over the time period  $T_2$  to  $T_3$  (30 to 100ms - dependent on the type of anomaly). If the anomaly persists, as shown above, the current is again reset to 0 A for a further 2 s ( $T_3$  to  $T_4$ ). This "hiccup" process is repeated until the anomaly is removed ( $T_n$ ), whereon the power supply then returns to normal working.

**Output specification**

**FB78-1 Output voltage vs output current (78.51)**

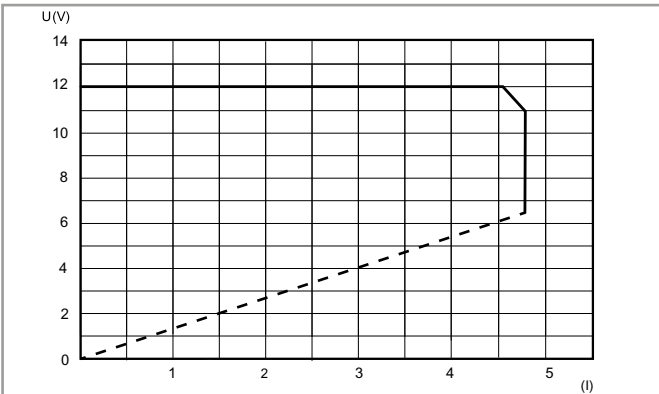

**FB78-2 Output voltage vs output current (78.61)**

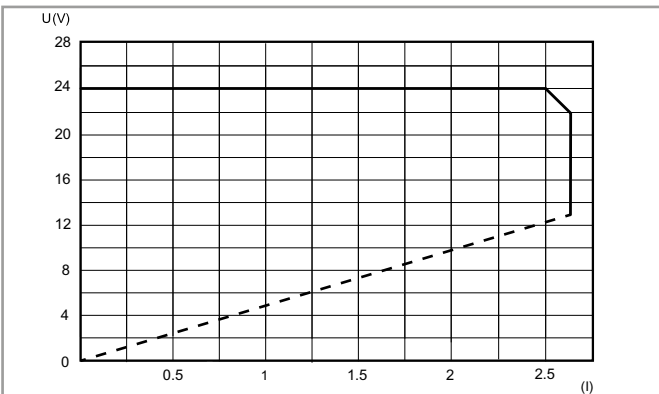

**FB78-3 Output voltage vs output current (78.1C)**

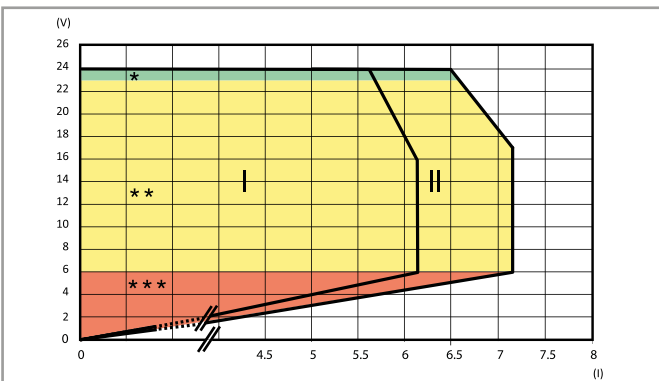

**I:** Fold-back characteristic for temperature up to 50 °C  
**II:** Fold-back characteristic for temperature up to 25 °C  
 \* / \*\* / \*\*\*: See LED table below

**FB78-5 Output voltage vs output current (78.2E)**

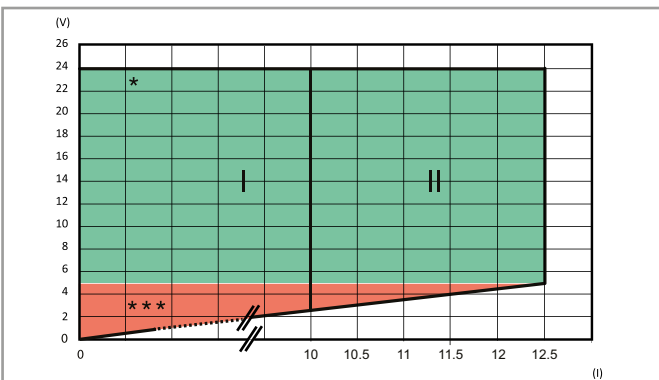

**I:** Output characteristic for temperature up to 50 °C  
**II:** Output characteristic for temperature up to 25 °C  
 \* / \*\*\*: See LED table below

**Fold-back technology** allows load current to be maintained under conditions of heavy overload. In case of heavy overload, the fold-back circuit will provide the output current and the output voltage, in accordance with the relevant "FB" diagram. In practice, when overcurrent is drawn by the load, the fold-back circuit reduces the output voltage supplying the current up to the maximal value, then it starts to work in hiccup mode. Also in case of short circuit, the power supply will work in hiccup mode. Both these conditions end when the anomaly is removed, and the power supply returns to normal working.

The fold-back mode allows the use of the power supply as a battery charger, in particular 78.51/61 for charging lead batteries rated 7...24 Ah and 78.1C/1D for charging lead batteries rated 17...38 Ah. It is suggested to insert a diode in series between the + output and the + input of the battery (if not already installed in the battery unit).

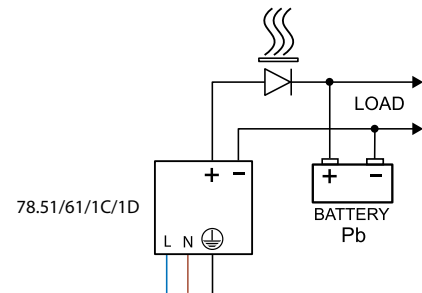

**FB78-4 Output voltage vs output current (78.1D)**

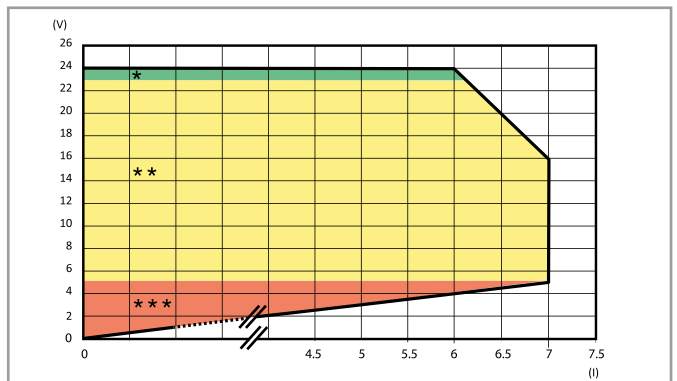























Fold-back characteristic for ambient temperature up to 50 °C  
 \* / \*\* / \*\*\*: See LED table below

## 78.1C, 78.1D, 78.2E LED table

## Feedback contact switching mode: Type 78.xx.x.xxx.24x4 ("positive logic")

The NO contact closes when power is applied to the unit and remains closed unless there is a serious fault preventing the power supply unit from delivering output current. (Such as a broken fuse, power supply failure, short-circuit or thermal protection.)

This version is suitable, for example, for signalling to a remote PLC all those alarms representing a service interruption of the power supply output.

Type	Area	State	LED	Contact 13-14
78.1C.1.230.2404 78.1D.1.230.2414 78.2E.1.230.2414	*	OK	DC OK  ALARM   OFF	
	**	Overload (78.1C/1D only)	DC OK  ALARM   OFF	
	***	Short circuit	DC OK  ALARM   OFF	
		Thermal limit	DC OK  ALARM   OFF	
		Thermal protection <sup>#</sup>	DC OK  ALARM   OFF	

<sup>#</sup>Remove the supply voltage, following the intervention of the thermal protection, in order to reset the power supply.























## 78.1C, 78.1D, 78.2E LED table

F

## Feedback contact switching mode: Type 78.xx.x.xxx.24x5 ("pre-alarm")



The NO contact closes when an anomaly happens (Overload, short circuit, thermal limit, thermal protection).

This version is suitable, for example, for activating visual or audible alarms, or to activate a cooling fan.

Type	Area	State	LED	Contact 13-14
78.1C.1.230.2405 78.1D.1.230.2415 78.2E.1.230.2415	*	OK	DC OK  ALARM   OFF	
	**	Overload (78.1C/1D only)	DC OK  ALARM   OFF	
	***	Short circuit	DC OK  ALARM   OFF	
		Thermal limit	DC OK  ALARM   OFF	
		Thermal protection <sup>#</sup>	DC OK  ALARM   OFF	

<sup>#</sup>Remove the supply voltage, following the intervention of the thermal protection, in order to reset the power supply.

## 78.12, 78.36, 78.50, 78.60, 78.51, 78.61 LED table

Type	State	LED
78.12.1.230.xx00 78.36.1.230.2401 78.50.1.230.1203 78.60.1.230.2403 78.51.1.230.1203 78.61.1.230.2403	OK	
	Short circuit	
	Thermal limit	OFF

**Wiring diagrams for 78.12, 78.36, 78.50, 78.51, 78.60 & 78.61**

**Basic connections**

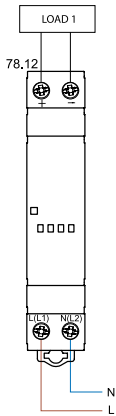

**Basic connections**

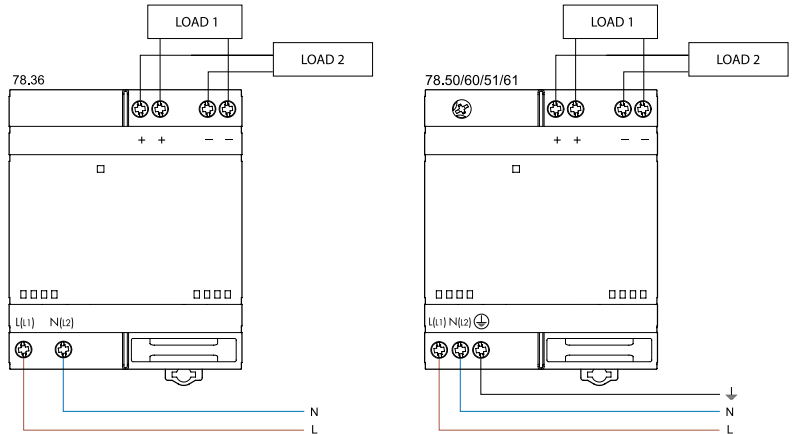

**Dual polarity connection**

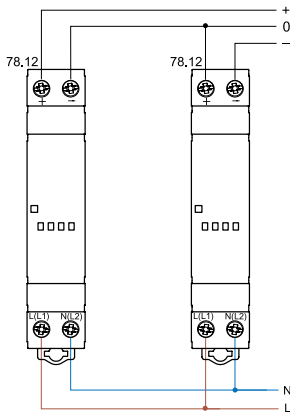

**Dual polarity connection**

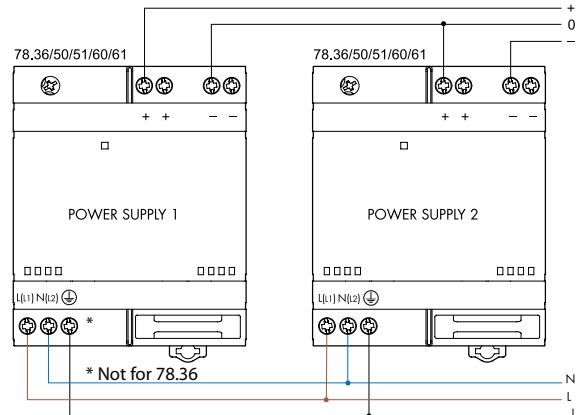

**Series connection**

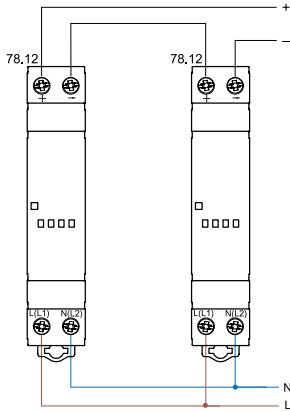

**Series connection**

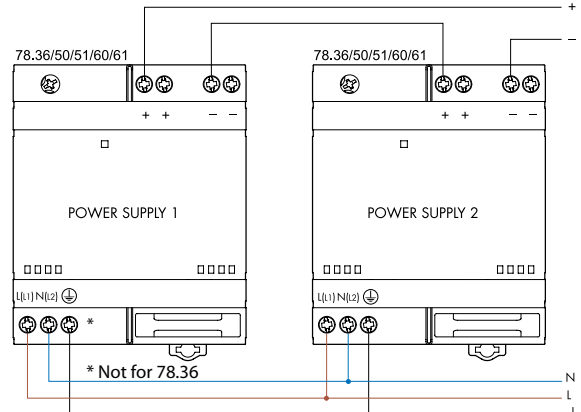

**Parallel connection (78.51/61 only)**

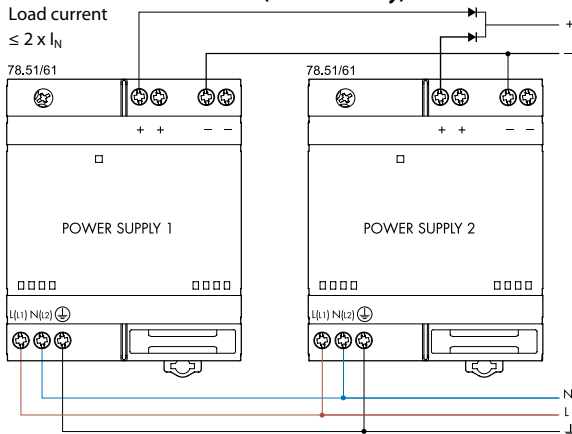

**Manual redundancy**

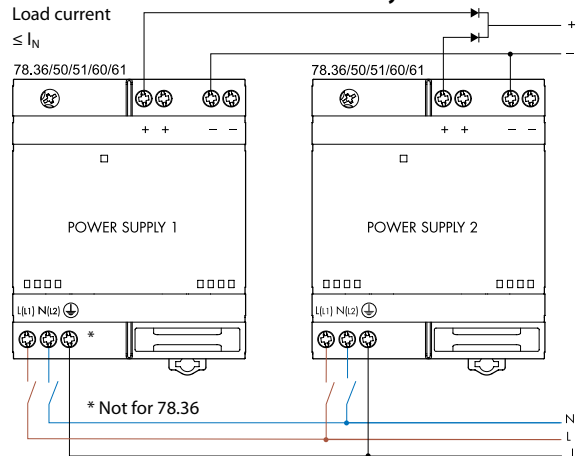

Wiring diagrams for 78.1C & 78.1D

Basic connections

78.1C - Power supply connection

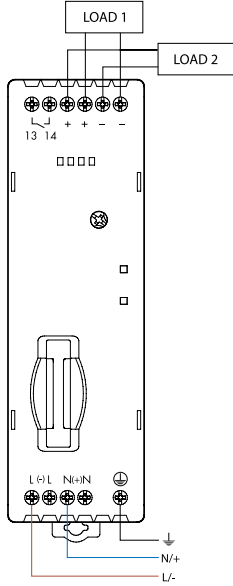

78.1D - Power supply connection

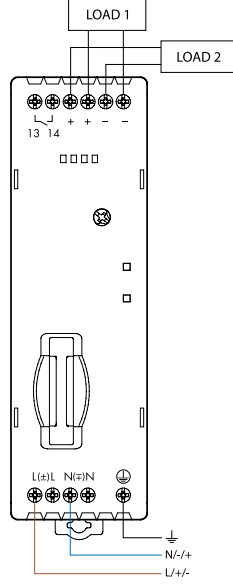

Dual polarity connection

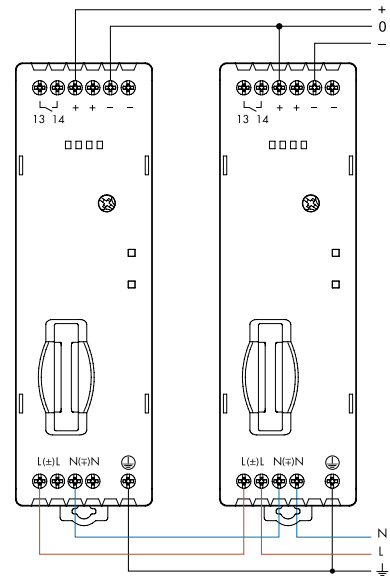

Parallel connection

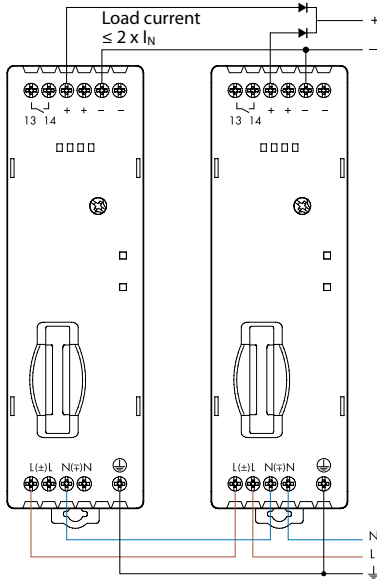

Series connection

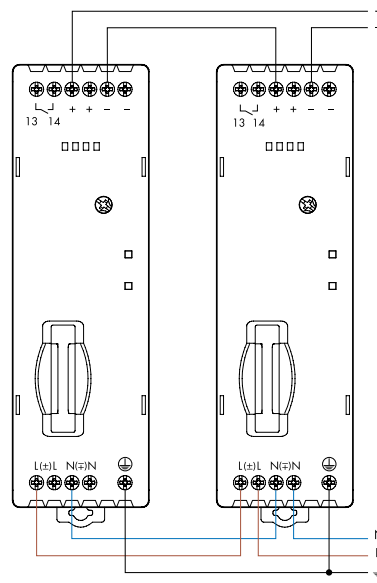

F

**Wiring diagrams for 78.2E**

**Basic connections**

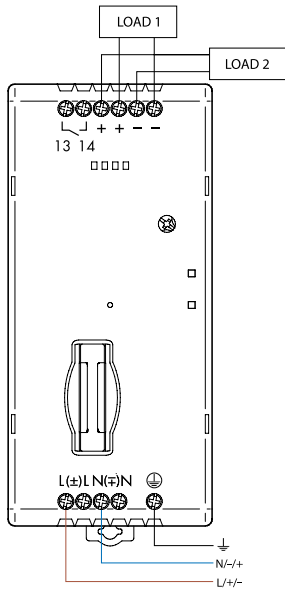

**Dual polarity connection**

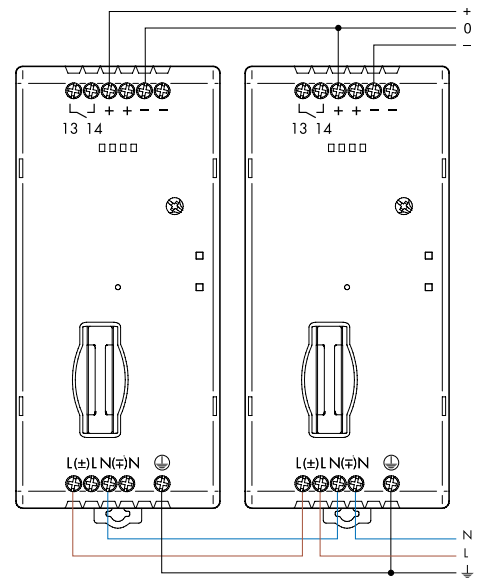

**Parallel connection**

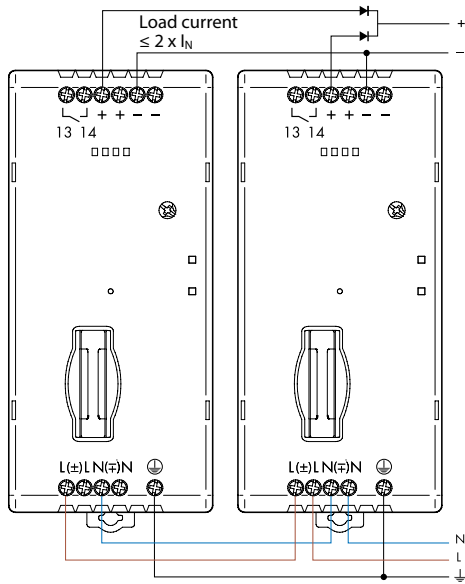

**Series connection**

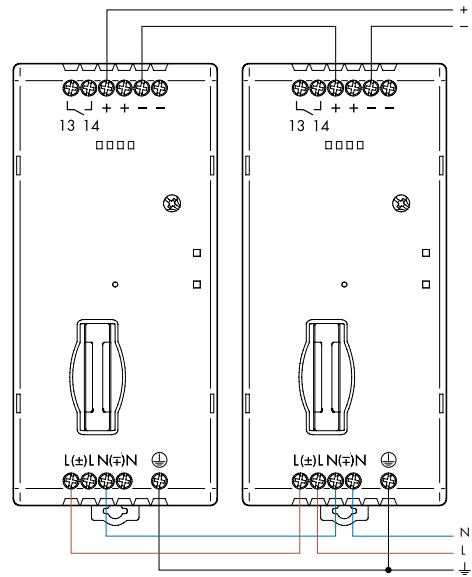

Diode(s)

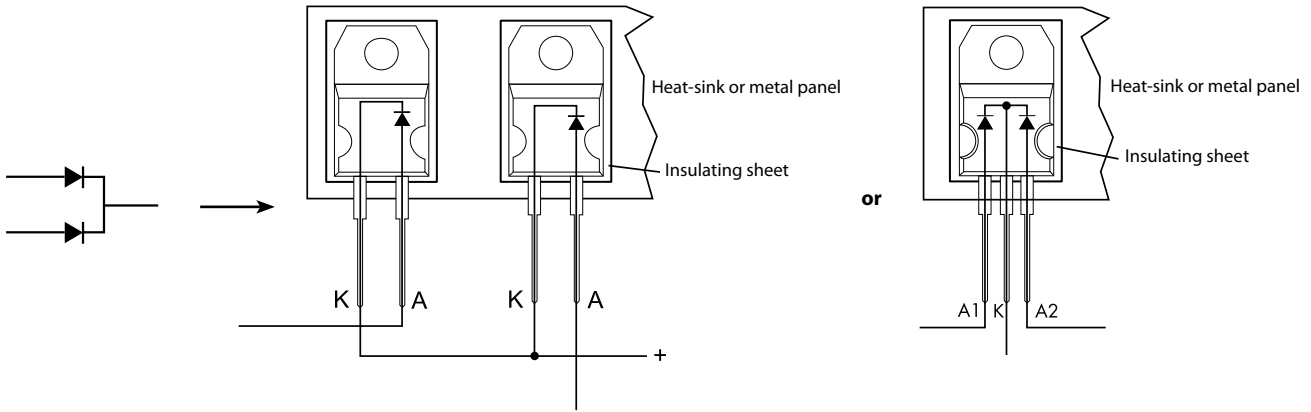

Diode for type 78.12, 78.36, 78.50, 78.60

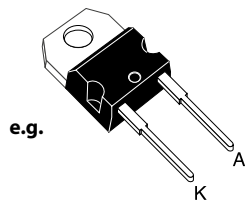

e.g.

**TO-220AC**  
**STPS1545D**

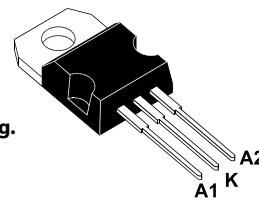

e.g.

**TO-220AB**  
**STPS30L40CT**

Diode for type 78.1C, 78.1D, 78.2E

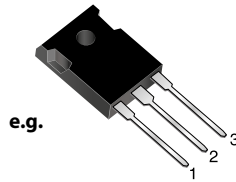

e.g.

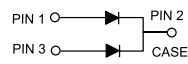

**TO-247AD**  
**MBR 4060PT**

**Outline drawings**

78.12  
Screw terminal

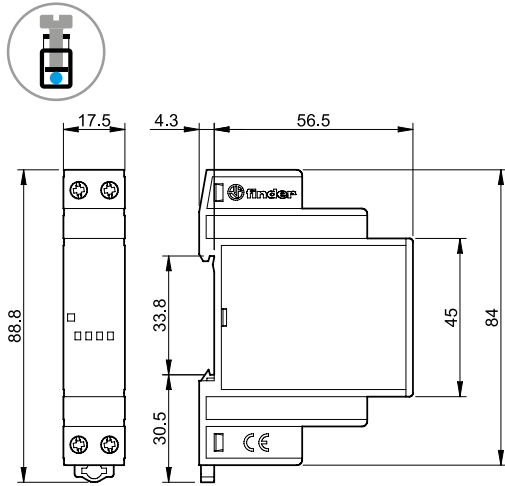

78.36  
Screw terminal

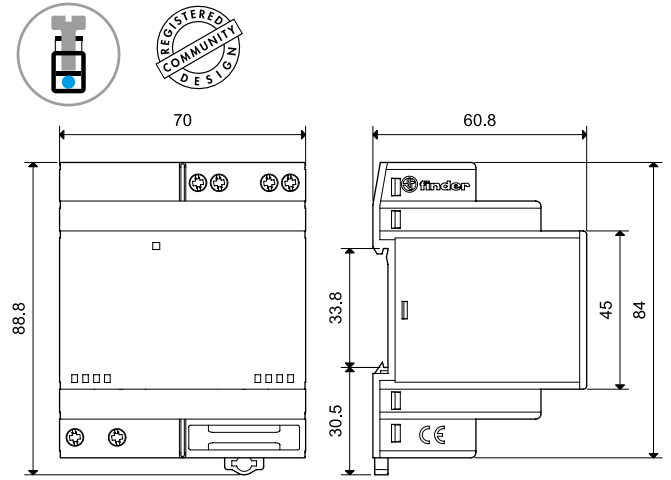

78.50 / 78.60  
Screw terminal

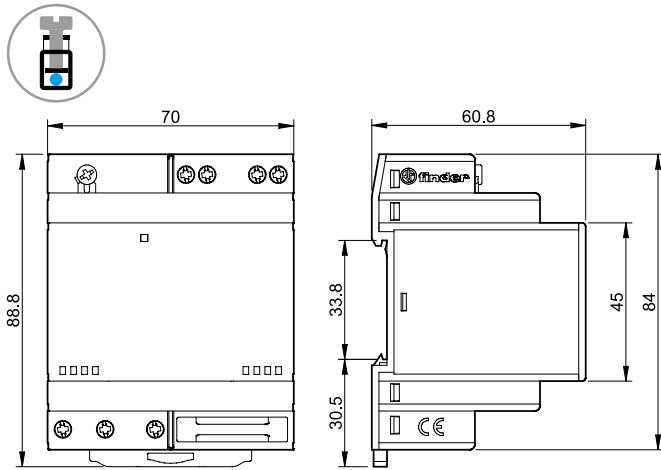

78.51 / 78.61  
Screw terminal

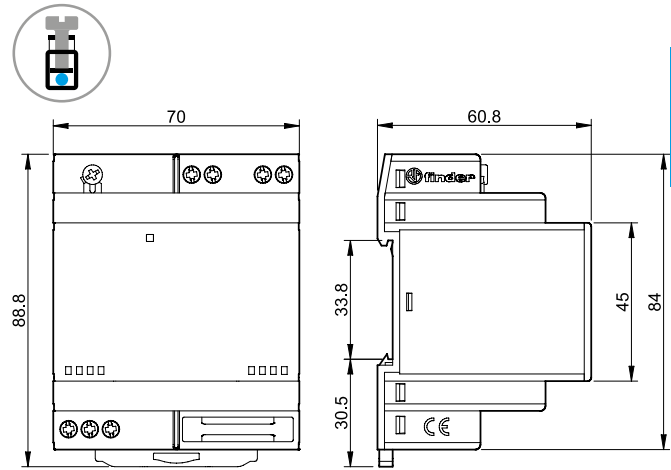

78.1C / 78.1D  
Screw terminal

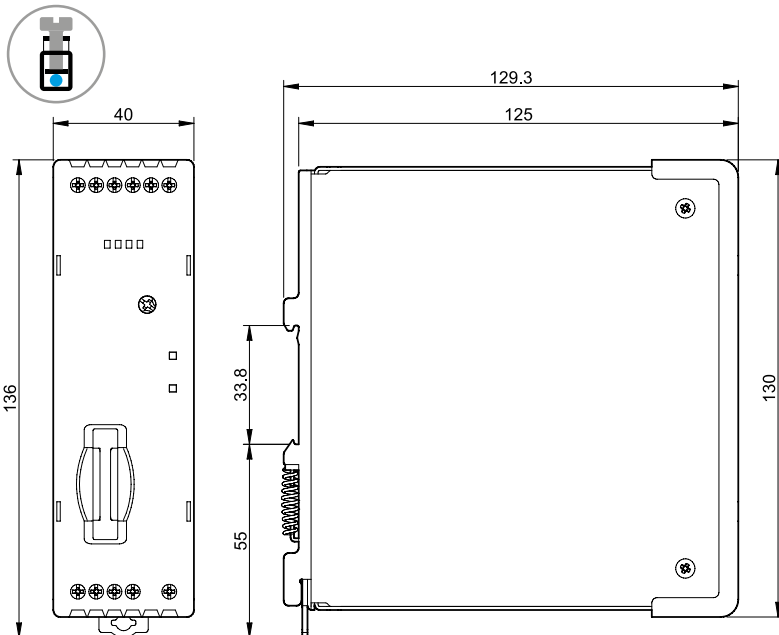

## Outline drawings

78.2E

Screw terminal

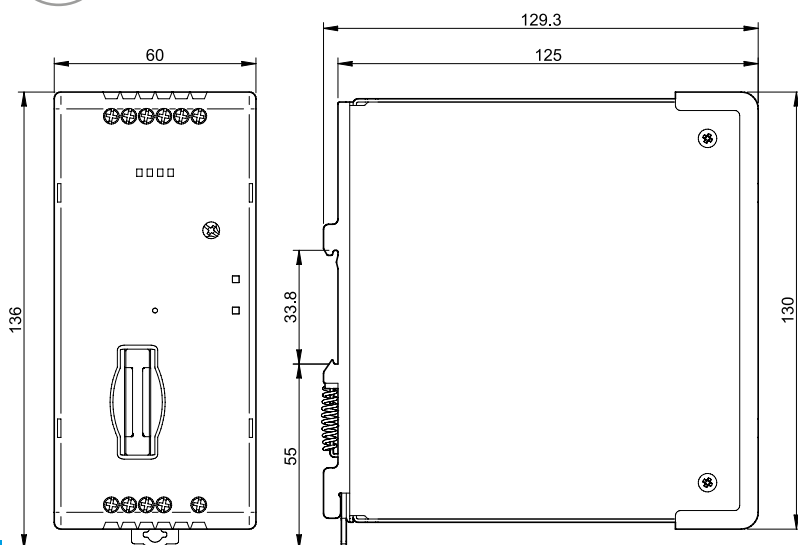

F

## Accessories



Sheet of marker tags, plastic, 72 tags, 6 x 12 mm

060.72

060.72

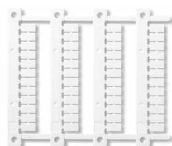

NEW

Sheet of marker tags (CEMBRE'S Thermal transfer printers), (48 tags), 6 x 12 mm

060.48

060.48



Identification tag, plastic, 1 tag, 17 x 25.5 mm (for 78.12/36/50/60/51/61)

019.01

019.01