

CM5022R151R-10

UNCONTROLLED DOCUMENT



PHYSICAL DIMENSIONS:

A	12.57 [.495]	+ 0.20 [.008]
B	5.72 [.225]	+ 0.10 [.004]
B ₁	6.73 [.265]	MAX
C	7.62 [.300]	+ 0.13 [.005]
C ₁	8.40 [.330]	MAX.
D	2.41 [.095]	+ 0.08 [.003]
E	0.89 [.035]	+ 0.13 [.005]
E ₁	1.91 [.075]	+ 0.13 [.005]

WIRE:

T ₁	1.91 [.075]	+ 0.25 [.010]
T ₂	0.38 [.015]	TYP.
T ₃	0.38 [.015]	TYP.

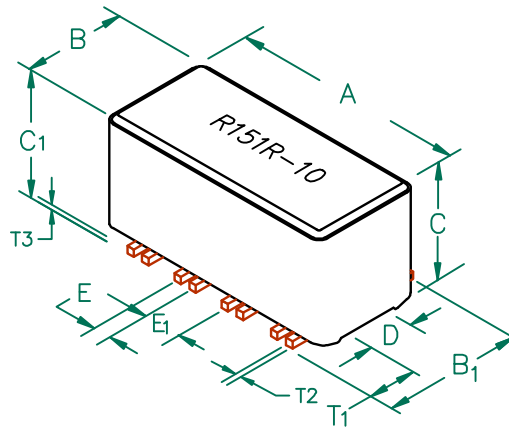

ELECTRICAL CHARACTERISTICS:			
Z @ 100MHz (Ω)	DCR (Ω)	Rated Current	Rated Voltage (VDC)
Nominal	150		
Minimum	120		
Maximum	-	5,000 mA	30

NOTES: UNLESS OTHERWISE SPECIFIED

1. TAPED AND REELED per CURRENT EIA SPECIFICATIONS 13" REELS, 600 PCS PER REEL.
2. COMPONENTS SHOULD BE ADEQUATELY PREHEATED BEFORE SOLDERING.
3. REF. CARRIER TAPE SPECIFICATION # CART5022-1P.
4. TERMINATION FINISH IS 100% TIN.
5. OPERATION TEMPERATURE (INCLUDING SELF-HEATING): -40 ~ +125°C.

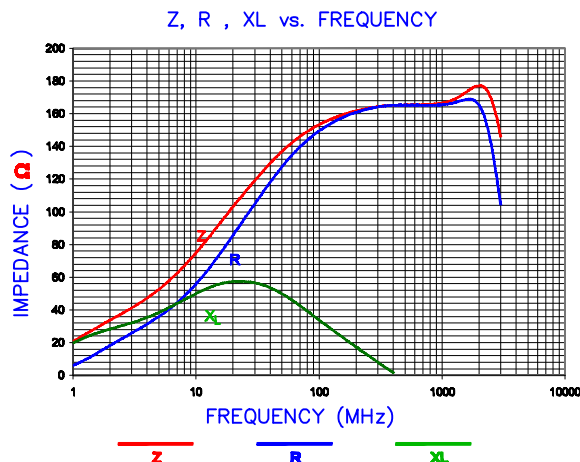
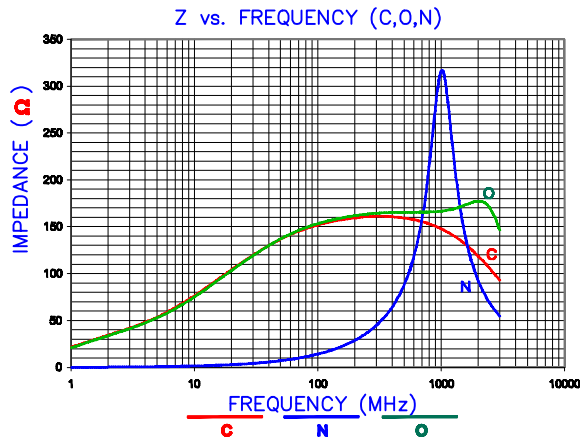

LAND PATTERNS FOR REFLOW SOLDERING

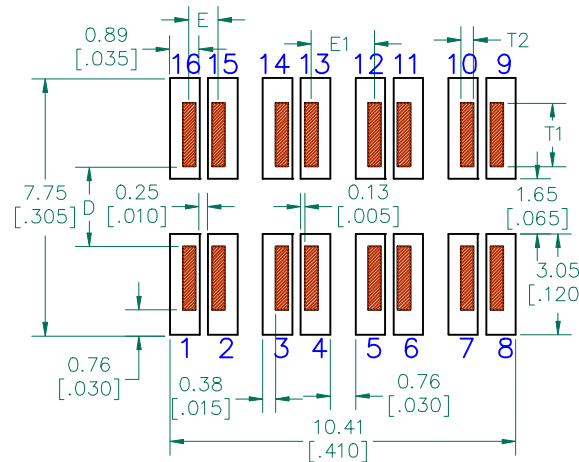

RECOMMENDED SOLDERING CONDITIONS

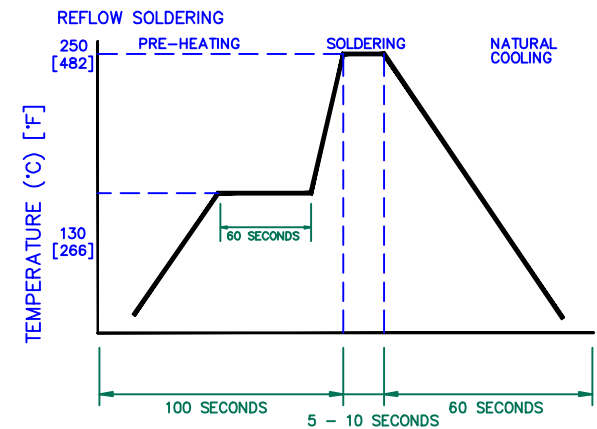

EQUIVALENT CIRCUIT NO POLARITY

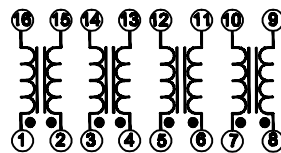

DIMENSIONS ARE IN mm (INCHES).				This print is the property of Laird Tech. and is loaned in confidence subject to return upon request and with the understanding that no copies shall be made without the written consent of Laird Tech. All rights to design or invention are reserved.			
D	ADD RATED VOLTAGE AND NOTE 5	08/30/12	QIU	PROJECT/PART NUMBER:	REV	PART TYPE:	DRAWN BY:
C	UPDATE COMPANY LOGO ADD EQUIVALENT CIRCUIT	02/03/09	JRK	CM5022R151R-10	D	ASSEMBLY	JRK
B	UPDATE COMPANY LOGO, ADD ROHS	12/12/07	JRK	DATE: 04/27/04	SCALE:	NTS	SHEET:
A	ORIGINAL DRAFT	04/27/04	JRK	CAD #	TOOL #		
REV	DESCRIPTION	DATE	INT	CM5022R151R-10-D-2	H0495-1		



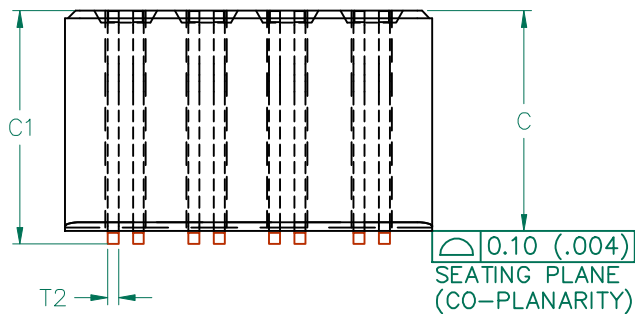
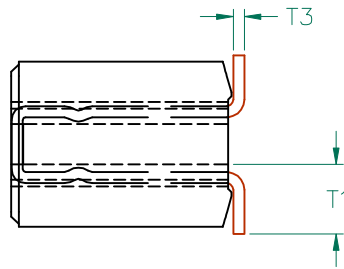
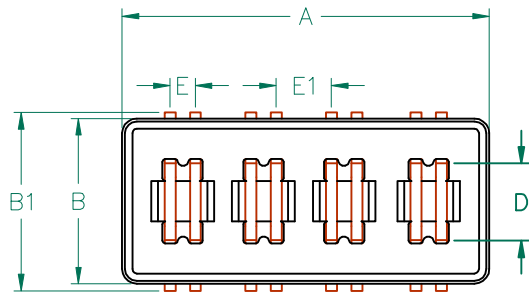

UNCONTROLLED DOCUMENT

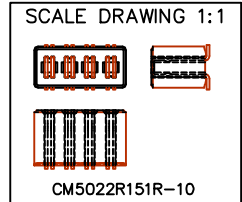

ELECTRICAL TESTING

	GROSS	GROSS
TEST:	Z	Z
# TURNS	1	1
AWG	22	22
FREQUENCY	25 MHz	100 MHz
NOMINAL	110 Ω	150 Ω
MINIMUM	85 Ω	120 Ω
WEIGHT/1000	2.36 kgs.	5.21 lbs.

DIMENSIONS:

A	12.57 [.495]	+ 0.20 [.008]
B	5.72 [.225]	+ 0.10 [.004]
B ₁	6.73 [.265]	MAX
C	7.62 [.300]	+ 0.13 [.005]
C ₁	8.40 [.330]	MAX.
D	2.41 [.095]	+ 0.08 [.003]
E	0.89 [.035]	+ 0.13 [.005]
E ₁	1.91 [.075]	+ 0.13 [.005]



NOTES: UNLESS OTHERWISE SPECIFIED

1. WIRE: REFERENCE STEWARD WIRE PURCHASE SPEC. W0022-*
2. IMPEDANCE VALUES ARE GROSS, MEASURED USING W0022-* WIRE PLACED AGAINST END OF SLOT w/ NO D.C. BIAS.
3. REFERENCE STEWARD CORE 24H0495-100.
4. NO MORE THAN 0.18 [.007] DIFFERENCE FROM THE LONGEST TO THE SHORTEST CONDUCTOR ON ONE SIDE.
5. TERMINATION FINISH IS 100% TIN.

WIRE DIMENSIONS:

T ₁	1.91 [.075]	+ 0.25 [.010]
T ₂	0.38 [.015]	TYP.
T ₃	0.38 [.015]	TYP.

DIMENSIONS ARE IN mm (INCHES).				This print is the property of Laird Tech. and is loaned in confidence subject to return upon request and with the understanding that no copies shall be made without the written consent of Laird Tech. All rights to design or invention are reserved.		Laird TECHNOLOGIES	
D	ADD RATED VOLTAGE AND NOTE 5	08/30/12	QIU	PROJECT/PART NUMBER:	REV	PART TYPE:	DRAWN BY:
C	UPDATE COMPANY LOGO ADD EQUIVALENT CIRCUIT	02/03/09	JRK	CM5022R151R-10	D	ASSEMBLY	JRK
B	UPDATE COMPANY LOGO, ADD ROHS	12/12/07	JRK	DATE: 04/27/04	SCALE: NTS	SHEET:	
A	ORIGINAL DRAFT	04/27/04	JRK	CAD #	TOOL #	3 of 3	
REV	DESCRIPTION	DATE	INT	CM5022R151R-10-D-3	H0495-1		