

PHYSICAL DIMENSIONS:

A	7.50 [.295]	+	MAX.
A ₁	9.00 [.354]	+	0.40 [.016]
B	5.50 [.217]	+	MAX.
C	3.80 [.150]	+	MAX.
C ₁	4.90 [.193]	+	MAX.
D	2.54 [.100]	+	0.10 [.004]
T ₁	1.75 [.069]	+	TYP.
T ₂	0.50 [.020]	+	0.10 [.004]
T ₃	0.30 [.012]	+	0.10 [.004]

WEIGHT/1000 0.28 kgs [.62 Lbs]

CM2824E352R-10

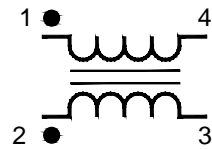
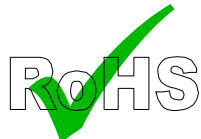
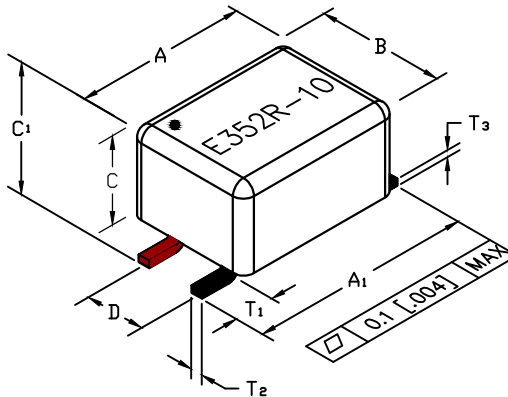

ELECTRICAL SPECIFICATION @ 25°C
OPERATING TEMPERATURE RANGE: -40°C TO +125°C

PARAMETER SYMBOL	REQUIREMENTS		
	MIN	TYP	MAX
Z SPEC Ω @ 100 MHz	2,625	3,500	
DCR (Ω)			0.30
RATED CURRENT (mA)			800
RATED VOLTAGE (Vdc)			80

NOTES: UNLESS OTHERWISE SPECIFIED

1. TAPED AND REELED ON 13" REELS, 1500 PCS/REEL.
2. OPEN BOTTOM CONSTRUCTION.
3. COMPONENTS SHOULD BE ADEQUATELY PREHEATED BEFORE SOLDERING.

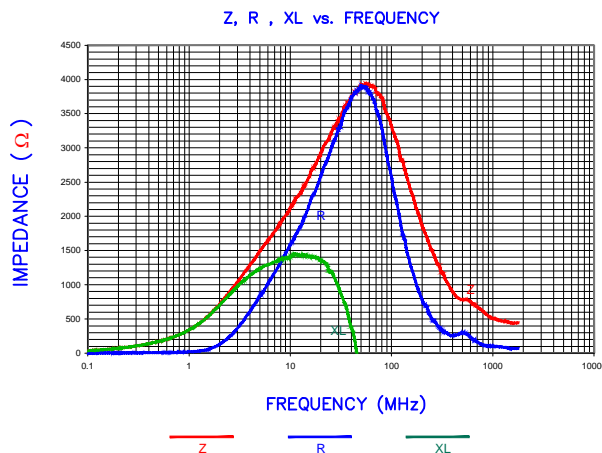
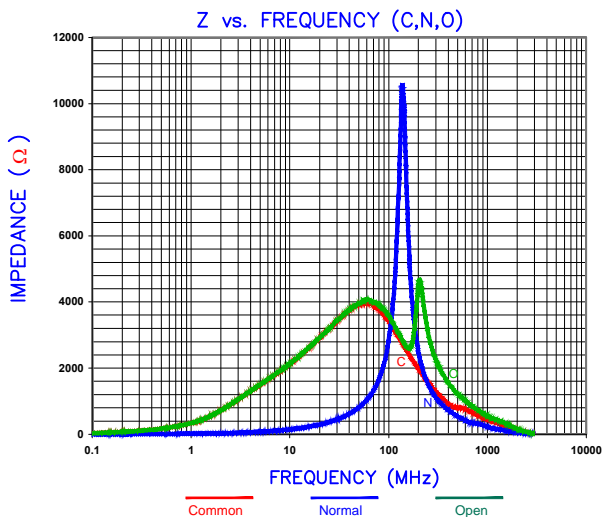

LAND PATTERNS FOR REFLOW SOLDERING

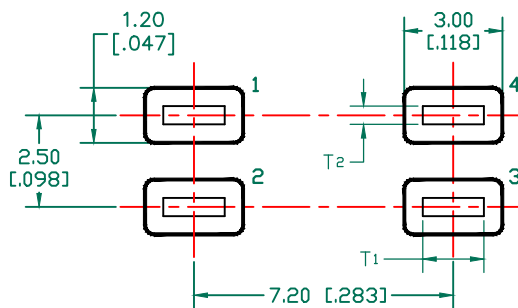

RECOMMENDED SOLDERING CONDITIONS

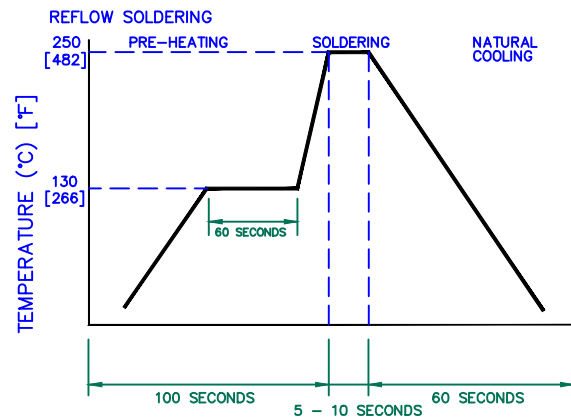

DIMENSIONS ARE IN mm [INCHES].				This print is the property of Laird Tech. and is loaned in confidence subject to return upon request and with the understanding that no copies shall be made without the written consent of Laird Tech. All rights to design or invention are reserved.			
F	CHANGE MARKING	07/18/16	QIU	PROJECT/PART NUMBER: CM2824E352R-10	REV F	PART TYPE: COMMON MODE CHOKE	DRAWN BY: JRK
E	ADD RATING VOLTAGE	07/25/13	QIU				
D	REMOVE IMPEDANCE UPPER SPEC	02/02/10	JUN				
C	UPDATE COMPANY LOGO	05/06/09	JRK				
B	UPDATE COMPANY LOGO	11/20/07	JRK				
A	ORIGINAL DRAFT	05/16/06	JRK	DATE: 05/16/06	SCALE: NTS	SHEET: 1 of 1	
REV	DESCRIPTION	DATE	INT	CAD # CM2824E352R-10-F	TOOL # -		