



Contents

<i>Description</i>		<i>Page</i>	
Fuse holder and block selection guide		1-2	
Class fuse dimensions		1-5	
Fuses by fuse class			
Class	Fuses	Volts	
CC	LP-CC	600V	1-7
	FNQ-R	600V	1-8
	KTK-R	600V	1-9
CF	TCF*	600V	1-10
	FCF	600V	1-12
	WCF	600V	1-14
	*Class J performance		
CF	Holder system	600V	1-16
G	SC	600/480V	1-18
J	LPJ_SP	600V	1-19
	LPJ_SPI indicator	600V	1-19
	JKS	600V	1-20
K5 and H	NON	250V	1-21
	NOS	600V	1-21
L	KRP-C_SP	600V	1-22
	KRP-CL	600V	1-23
	KLU	600V	1-24
	KTU	600V	1-24
RK1	LPN-RK_SP	250V	1-25
	LPN-RK_SPI indicator	250V	1-25
	LPS-RK_SP	600V	1-25
	LPS-RK_SPI indicator	600V	1-25
	KTN-R	250V	1-28
KTS-R		600V	1-29
RK5	FRN-R (energy efficient)	250V	1-30
	FRN-R_ID (energy efficient)	250V	1-30
	FRS-R (energy efficient)	600V	1-31
	FRS-R_ID (energy Efficient)	600V	1-31
T	JJN	300V	1-32
	JJS	600V	1-33
Plug fuses	SL, TL and W	125V	1-34
	P, S, T and TC	125V	1-35
	MB Edison base circuit breakers	125V	1-36
	SA fuse adapters		1-36

Low voltage branch circuit fuses

1

Low voltage, branch circuit fuses

Holders and blocks for branch circuit fuses

Class	Fuses	Volts	Page
CC	LP-CC	600V	1-7
	FNQ-R	600V	1-8
	KTK-R	600V	1-9

Holders

- OPM-NG-SC3 3-pole, panel/DIN-Rail mount 9-12
- OPM-1038R 3-pole, panel/DIN-Rail mount 9-11
- OPM-1038RSW 3-pole w/ switch, panel/DIN-Rail mount 9-10
- CHCC_D 1 to 3-pole, DIN-Rail mount 9-2
- HPF-RR front panel mount 9-53
- HPS-RR front panel mount 9-53

Blocks

- BCM panel/DIN-Rail mount 9-32



OPM-NG-SC3



OPM-1038R and
OPM-1038RSW

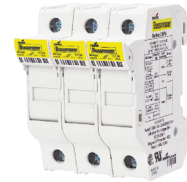

CHCC_D



HPF-RR



HPS-RR



BCM

Class	Fuses	Volts	Page
G	SC	600/480V	1-18

Holders

- HP front panel accessible, front panel mount 9-53

Blocks

- BG panel/DIN-Rail with adapters 9-40
- G panel/DIN-Rail with adapters 9-40



HP



BG and G

Class	Fuses	Volts	Page
K5 and H	NON	250V	1-21
	NOS	600V	1-21

Blocks

- Modular knifeblade fuse blocks 250/600V, panel mount 9-17
- Modular type fuse blocks 250/600V, panel mount 9-41
- HM250 1 to 3-pole 250V, panel/DIN-Rail mount 9-24
- HM600 1 to 3-pole 600V, pane/DIN-Rail mount 9-24



Modular knifeblade



Modular type



HM250



HM600

Low voltage, branch circuit fuses

Holders and blocks for branch circuit fuses

Low voltage
branch circuit
fuses

Class	Fuses	Volts	Page
L	KRP-C_SP	600V	1-22
	KRP-CL	600V	1-23
	KLU	600V	1-24
	KTU	600V	1-24

Blocks

- 51215 1-pole, panel mount*
- 51235 3-pole, panel mount*

*Call our customer satisfaction team at 636-527-3877 for more information.



51215



51235

Class	Fuses	Volts	Page
RK1	LPN-RK_SP	250V	1-25
	LPS-RK_SP	600V	1-25
	KTN-R	250V	1-28

Blocks

- Modular knifeblade fuse blocks 250/600V, panel mount . . . 9-17
- RM250 1- to 3-pole 250V, panel/DIN-Rail mount 9-24
- RM600 1- to 3-pole 600V, panel/DIN-Rail mount 9-24



Modular knifeblade



RM250



RM600

Class	Fuses	Volts	Page
RK5	FRN-R	250V	1-30

Blocks

- Modular knifeblade fuse blocks 250/600V, panel mount . . . 9-17
- RM250 1- to 3-pole 250V, panel/DIN-Rail mount 9-24
- RM600 1- to 3-pole 600V, panel/DIN-Rail mount 9-24



Modular knifeblade



RM250



RM600

Class	Fuses	Volts	Page
T	JJN	300V	1-32
	JJS	600V	1-33

Blocks

- BH modular-style, panel mount (<60A) 9-41
- T300 1- to 4-pole 300V, panel mount 9-36
- T600 1- to 3-pole 600V, panel mount 9-38



BH



T300



T600

1

Low voltage, branch circuit fuses

Holders and blocks for branch circuit fuses

Class	Fuses	Volts	Page
J, CF	TCF*, FCF, WCF	600V	1-10
	LPJ-SP	600V	1-19
	JKS	600V	1-20

*Class J performance

Holders

- TCFH CUBEFuse holder, panel/DIN-Rail mount 1-16
- CH Class J modular 1- to 3-pole, panel/
DIN-Rail mount 9-11
- Safety J™ modular holders,
panel/DIN-Rail mount 9-14

Blocks

- Power distribution fuse block 9-22
- Modular knifeblade fuse blocks 250/600V, panel mount . . 9-17
- JM600, panel/DIN-Rail mount 9-24
- JP pyramid blocks, panel mount 9-31
- Modular type fuse blocks 600V, panel mount 9-41
- BH modular-style open blocks, panel mount 9-41



Class	Fuses	Volts	Page
Plug fuses	W, TL, T, P and TC	125V	1-34 - 1-36

Box cover units

- Standard electrical box mounting 9-42



Fuse reducers for Class R fuses 250V

Equipment fuse clip amps	Desired fuse (case) amp size	Catalog no. (pairs) 250V
60	30	NO.263-R
100	30	NO.213-R
	60	NO.216-R
200	60	NO.226-R
	100	NO.2621-R
400	100	NO.2641-R
	200	NO.242-R
600	100	NO.2661-R
	200	NO.2662-R
	400	NO.2664-R*

*Single reducer only (pair not required).

Fuse reducers for Class R fuses 600V

Equipment fuse clip amps	Desired fuse (case) amp size	Catalog no. (pairs) 600V
60	30	NO.663-R
100	30	NO.216-R
	60	NO.616-R
200	60	NO.626-R
	100	NO.2621-R
400	100	NO.2641-R
	200	NO.642-R
600	100	NO.2661-R
	200	NO.2662-R
	400	NO.2664-R*

*Single reducer only (pair not required).

Class J dimensions - in (mm)

Low-Peak™ and Limitron™ fuses LPJ and JKS – 600V

Amp Range	A	B	C	D	E	F	G	H	I
1-30	2.25 (57.2)	0.81 (20.6)	—	—	0.50 (12.7)	—	—	—	—
35-60	2.38 (60.3)	1.06 (27.0)	—	—	0.63 (15.9)	—	—	—	—
70-100	4.63 (117.5)	1.13 (28.6)	3.63 (92.1)	2.63 (66.7)	1.00 (25.4)	0.75 (28.6)	0.13 (3.2)	0.41 (10.4)	0.28 (7.1)
110-200	5.75 (146.1)	1.63 (41.4)	4.38 (111.1)	3.00 (76.2)	1.38 (34.9)	1.13 (28.6)	0.19 (4.8)	0.38 (9.5)	0.28 (7.1)
225-400	7.12 (181.0)	2.11 (53.6)	5.25 (133.3)	3.26 (82.8)	1.87 (47.6)	1.62 (41.2)	0.25 (6.4)	0.56 (14.2)	0.40 (10.3)
450-600	8.00 (203.2)	2.60 (66.0)	6.00 (152.4)	3.31 (84.0)	2.12 (54.0)	2.00 (50.8)	0.53 (13.5)	0.72 (18.3)	0.53 (13.5)

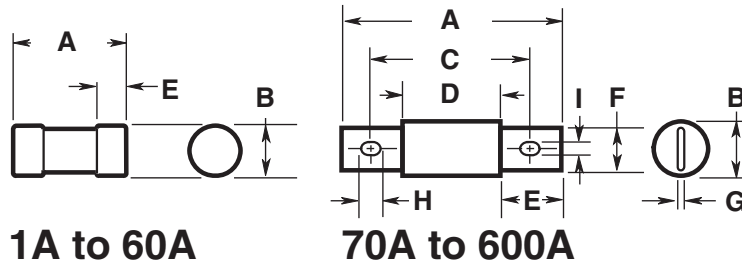

1A to 60A

70A to 600A

Class CC dimensions - in (mm)

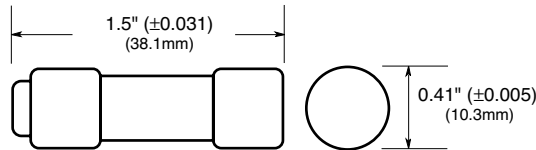

Class RK1 and RK5 dimensions - in (mm)

Basic dimensions are same as Class H, one-time (NON and NOS) and superlag renewable RES and REN fuses. NOTE: These fuses can be used to replace existing Class H, RK1 and RK5 fuses relating to dimensional compatibility.

Ferrule styles

Amp range	250V		600V	
	A	B	A	B
1/2-30	2 (50.8)	0.56 (14.3)	5.0 (127.0)	0.81 (20.6)
35-60	3 (76.2)	0.81 (20.6)	5.5 (139.7)	1.06 (27.0)

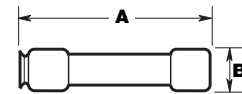

Fusetron — (FRN-R and FRS-R) and Limitron — (KTN-R and KTS-R)

Amp range	250V		600V	
	A	B	A	B
70-100	5.88 (149.2)	1.06 (26.9)	7.88 (200.0)	1.34 (34.0)
110-200	7.13 (181.0)	1.56 (39.6)	9.63 (244.5)	1.84 (46.7)
225-400	8.63 (219.1)	2.38 (60.5)	11.63 (295.3)	2.59 (65.8)
450-600	10.38 (263.5)	2.88 (73.2)	13.38 (339.7)	3.13 (79.5)

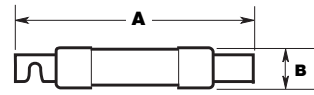

Low-Peak — (LPN-RK and LPS-RK)

Amp range	250V		600V	
	A	B	A	B
70-100	5.88 (149.2)	1.16 (29.5)	7.88 (200.0)	1.16 (29.5)
110-200	7.13 (181.0)	1.66 (42.2)	9.63 (244.5)	1.66 (42.2)
225-400	8.63 (219.1)	2.38 (60.5)	11.63 (295.3)	2.38 (60.5)
450-600	10.38 (263.5)	2.88 (73.2)	13.38 (339.7)	2.88 (73.2)

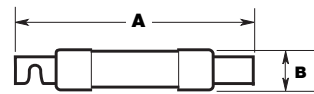

1

Low voltage, branch circuit fuses

Branch circuit fuses - dimensions

Class L dimensions - in (mm)

Low-Peak and Limitron fuses

Amp Range	A	B	C1	C2	D	F	G	I	J1	J2	J3	J4
601-800	8.63 (219.1)	2.40 (61.0)	6.75 (171.5)	5.75 (146.1)	3.75 (95.3)	2.00 (50.8)	0.38 (9.5)	0.63 (15.9)	—	—	—	—
801-1200	10.75 (273.1)	2.40 (61.0)	6.75 (171.5)	5.75 (146.1)	3.75 (95.3)	2.00 (50.8)	0.38 (9.5)	0.63 (15.9)	—	—	—	—
1350-1600	10.75 (273.1)	3.00 (76.2)	6.75 (171.5)	5.75 (146.1)	3.75 (95.3)	2.38 (60.3)	0.44 (11.1)	0.63 (15.9)	—	—	—	—
1800-2000	10.75 (273.1)	3.50 (88.9)	6.75 (171.5)	5.75 (146.1)	3.75 (95.3)	2.75 (69.9)	0.50 (12.7)	0.63 (15.9)	—	—	—	—
2001-2500	10.75 (273.1)	4.80 (122.0)	6.75 (171.5)	5.75 (146.1)	3.75 (95.3)	3.50 (88.9)	0.75 (19.1)	0.63 (15.9)	1.75 (44.5)	1.38 (34.9)	0.88 (22.2)	0.81 (20.6)
3000	10.75 (273.1)	5.00 (127.0)	6.75 (171.5)	5.75 (146.1)	3.75 (95.3)	4.00 (101.6)	0.75 (19.1)	0.63 (15.9)	1.75 (44.5)	1.38 (34.9)	0.88 (22.2)	0.81 (20.6)
3500-4000	10.75 (273.1)	5.75 (146.1)	6.75 (171.5)	5.75 (146.1)	3.75 (95.3)	4.75 (120.7)	0.75 (19.1)	0.63 (15.9)	1.75 (44.5)	1.38 (34.9)	1.63 (41.3)	0.88 (22.2)
4500-5000	10.75 (273.1)	6.25 (158.8)	6.75 (171.5)	5.75 (146.1)	3.75 (95.3)	5.25 (133.4)	1.00 (25.4)	0.63 (15.9)	1.75 (44.5)	1.38 (34.9)	1.63 (41.3)	0.88 (22.2)
6000	10.75 (273.1)	7.13 (181.0)	6.75 (171.5)	5.75 (146.1)	3.75 (95.3)	5.75 (146.1)	1.00 (25.4)	0.63 (15.9)	1.75 (44.5)	1.38 (34.9)	1.63 (41.3)	0.88 (22.2)

NOTE: KRP-CL (150A to 600A) fuses have same dimensions as 601-800A case size. KTU (200-600A) have same dimensions, except tube 3" length x 2" diameter (76.2 x 50.8mm); terminal 1 1/8" width x 1/4" thick (41.3 x 31.8mm).

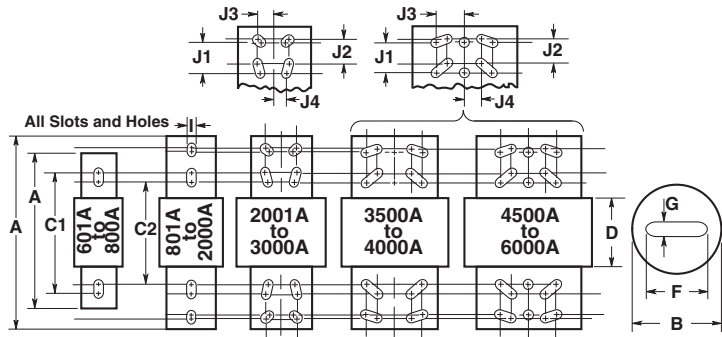

Class T dimensions - in (mm)

Limitron fuses

JJN — 300V

Amp range	A	B	C	D
1-30	0.88 (22.2)	0.41 (10.3)	—	—
35-60	0.88 (22.2)	0.56 (14.3)	—	—
70-100	2.16 (54.8)	0.75 (19.1)	1.56 (39.7)	0.84 (21.4)
110-200	2.44 (61.9)	0.88 (22.2)	1.69 (42.9)	0.84 (21.4)
225-400	2.75 (69.9)	1.00 (25.4)	1.84 (46.8)	0.86 (21.8)
450-600	3.06 (77.8)	1.25 (31.8)	2.03 (51.6)	0.88 (22.2)
601-800	3.38 (85.7)	1.75 (44.5)	2.22 (56.4)	0.89 (22.6)
801-1200	4.00 (101.6)	2.00 (50.8)	2.53 (64.3)	1.08 (27.4)

JJS — 600V

Amp range	A	B	C	D
1-30	1.50 (38.1)	0.56 (14.3)	—	—
35-60	1.56 (39.7)	0.81 (20.6)	—	—
70-100	2.95 (75.0)	0.75 (19.1)	2.36 (59.9)	1.64 (41.7)
110-200	3.25 (82.6)	0.88 (22.2)	2.50 (63.5)	1.66 (42.1)
225-400	3.63 (92.1)	1.00 (25.4)	2.72 (69.1)	1.73 (44.1)
450-600	3.98 (101.2)	1.25 (31.8)	2.96 (75.0)	1.78 (45.2)
601-800	4.33 (109.9)	1.75 (44.5)	3.17 (80.6)	1.88 (47.6)

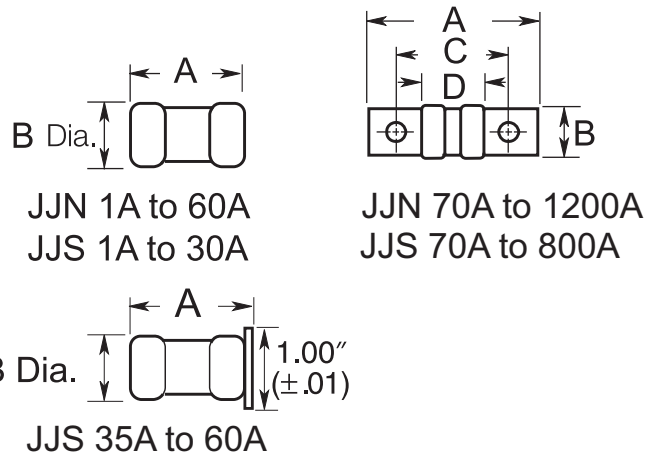

Low-Peak™ time-delay, rejection-type fuses

LP-CC Class CC

Specifications:

Description: Time-delay, current-limiting, rejection-type fuse – 12 seconds (minimum) at 200% rated amps.

Dimensions: 1/2" x 1 1/2" (10.3 x 38.1mm).

Ratings:

- Volts — 600Vac (or less)
 - 300Vdc (1/2-2 1/2A and 20-30A)
 - 150Vdc (2%₁₀-15A)
- Amps — 1/2-30A
 - IR — 200kA RMS Sym.
 - 20kA DC



Agency information: CE, Std. 248-4, Class CC, UL Listed, Guide JDDZ, File E4273, CSA Certified; Class 1422-02, File 53787, RoHS compliant (15-30A).

Features and benefits:

- Time-delay coupled with Class CC current-limiting response provides close sizing on small motor and relay circuits, and maximum component short-circuit current rating protection.
- 200kA interrupting rating provides high ratings for control circuit locations.
- Class CC rejection feature, with appropriate fuse block, prevents inserting lesser-rated supplementary fuses.
- Inventory consolidation of 1/2 x 1 1/2 inch supplementary fuses reduces SKU investment and minimizes potential for misapplying fuse.
- Selective coordination ratio of 2:1 (within Low-Peak fuse family) prevents electrical shutdowns from extending beyond the failed circuit.

Typical applications:

- Specialized circuits
- Industrial control
- Isolated, in-line fuse holder

Catalog numbers (amps)

LP-CC-1/2	LP-CC-2-1/2	LP-CC-7 1/2
LP-CC-3/8	LP-CC-2-3/8	LP-CC-8
LP-CC-3/8	LP-CC-3	LP-CC-9
LP-CC-1	LP-CC-3-3/8	LP-CC-10
LP-CC-1-1/8	LP-CC-3-1/2	LP-CC-12
LP-CC-1-1/4	LP-CC-4	LP-CC-15
LP-CC-1-3/8	LP-CC-4-1/2	LP-CC-20
LP-CC-1-1/2	LP-CC-5	LP-CC-25
LP-CC-1-5/8	LP-CC-5-3/8	LP-CC-30
LP-CC-1-3/4	LP-CC-6	
LP-CC-2	LP-CC-6-1/4	
LP-CC-2-1/4	LP-CC-7	

Time-current characteristics—average melt

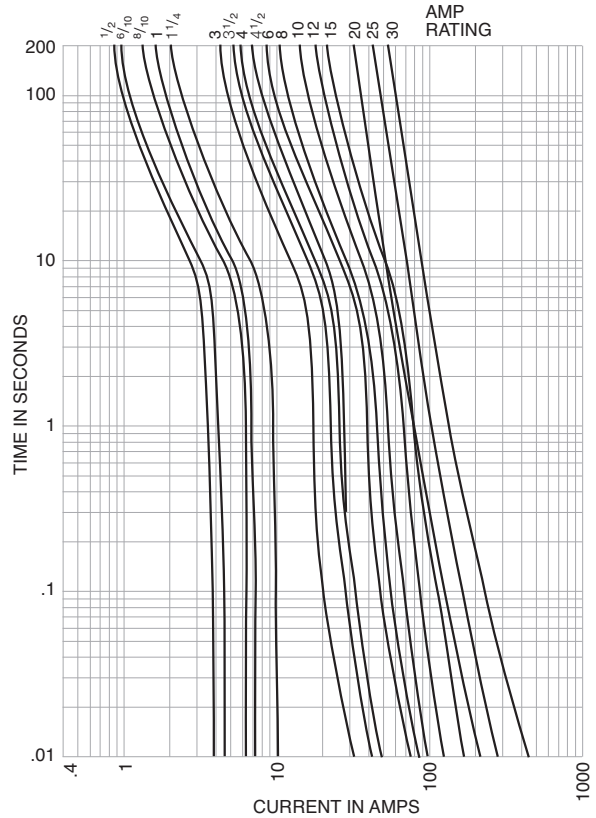

Low voltage branch circuit fuses

Current limitation curves

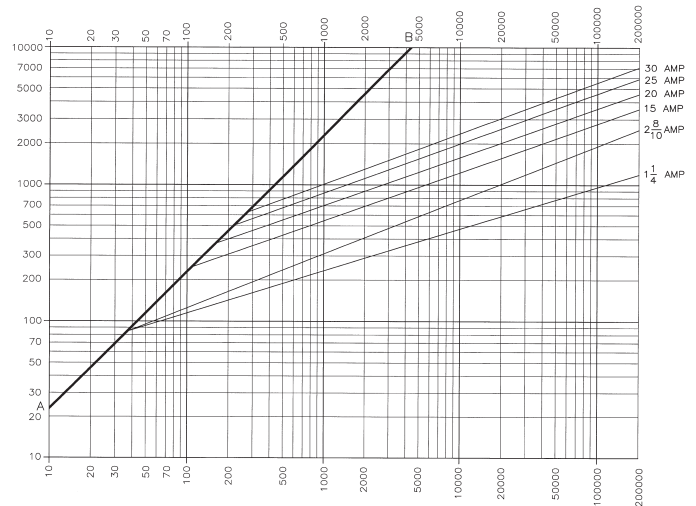

Recommended fuse holders and blocks for Class CC fuses

• See page 1-2

1

Low voltage, branch circuit fuses

Limitron rejection-type fuse

FNQ-R Class CC

Specifications:

Description: Time-delay, branch circuit, rejection-type fuse.

Dimensions: 1/2" x 1 1/2" (10.3 x 38.1mm).

Ratings:

- Volts — 600Vac (or less)
- 300Vdc (15-20A)
- 32Vdc (Self Certified)
- Amps — 1/4-30A
- IR — 200kA RMS Sym.
- 20kA DC (15 and 20A only)



Agency information: CE, Std. 248-4, Class CC, UL Listed, Guide JDDZ, File E4273 CSA Certified, Class 1422-01, File 53787, RoHS compliant.

Features and benefits:

- Time-delay compatible with inrush characteristic of small control transformers.
- Current limitation at Class CC levels provides maximum component short-circuit current rating protection.
- 200kA interrupting rating provides high ratings for control circuit locations.
- Class CC rejection feature, with appropriate fuse block, prevents inserting lesser-rated supplementary fuses.

Typical applications:

- Line protection, small control transformers
- Industrial control
- Isolated, in-line fuse holders

Catalog numbers (amps)

FNQ-R-1/4	FNQ-R-1-9/10	FNQ-R-6
FNQ-R-3/10	FNQ-R-1-3/10	FNQ-R-6-1/4
FNQ-R-3/10	FNQ-R-2	FNQ-R-7
FNQ-R-1/2	FNQ-R-2-1/4	FNQ-R-7-1/2
FNQ-R-9/10	FNQ-R-2-1/2	FNQ-R-8
FNQ-R-3/4	FNQ-R-2-9/10	FNQ-R-9
FNQ-R-9/10	FQN-R-3	FNQ-R-10
FNQ-R-1	FNQ-R-3-3/10	FNQ-R-12
FNQ-R-1-1/4	FNQ-R-3-1/2	FNQ-R-15
FNQ-R-1-1/4	FNQ-R-4	FNQ-R-17-1/2
FNQ-R-1-3/10	FNQ-R-4-1/2	FNQ-R-20
FNQ-R-1-4/10	FNQ-R-5	FNQ-R-25
FNQ-R-1-1/2	FNQ-R-5-9/10	FNQ-R-30

Time-current characteristic curves—average melt

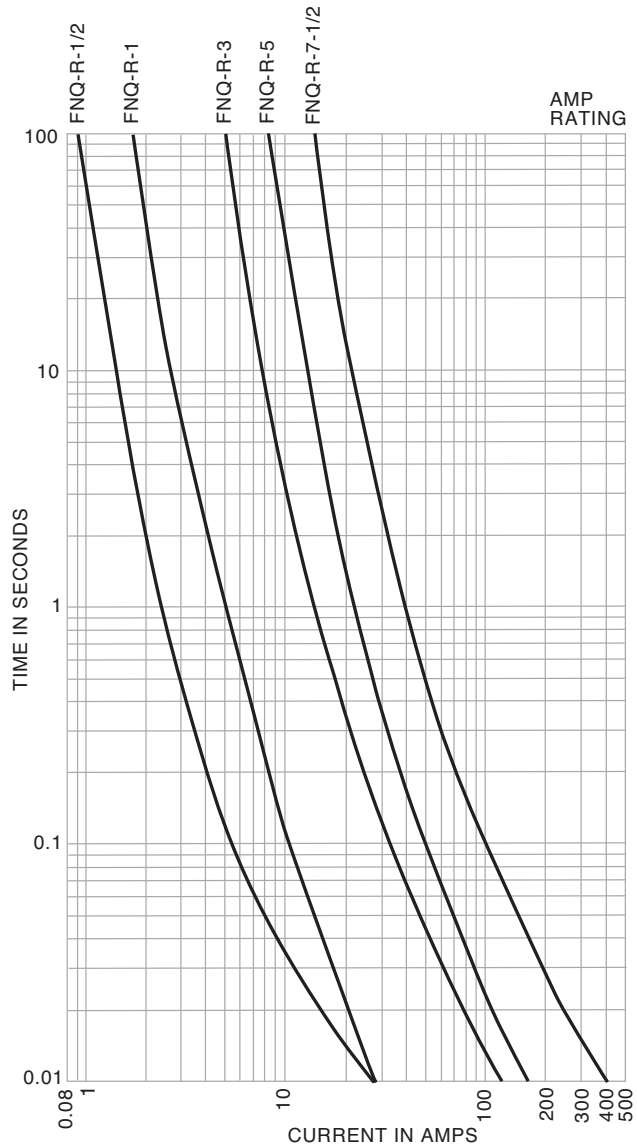

For superior electrical protection, Eaton recommends upgrading FNQ-R fuse applications to Bussmann series Low-Peak LP-CC fuses See page 1-7.

Recommended fuse holders and blocks for Class CC 600V fuses

- See page 1-2

Data Sheet: 1014

Low voltage, branch circuit fuses

Limitron™ rejection-type fuse

KTK-R Class CC

Specifications:

Description: Fast-acting, branch circuit, rejection-type fuse.

Dimensions: 13/32" x 1 1/2" (10.3 x 38.1mm).

Ratings:

Volts — 600Vac (or less)

Amps — 1/10-30A

IR — 200kA RMS Sym.

Agency information: CE, Std. 248-4, Class CC, UL Listed, Guide JDDZ, File E4273 CSA Certified, File 53787, Class 1422-02, RoHS compliant.



Features and benefits:

- Current limitation at Class CC levels provides maximum component short-circuit current protection.
- 200kA interrupting rating provides high ratings for control circuit locations.
- Class CC rejection feature, with appropriate fuse block, prevents inserting lesser-rated supplementary fuses.

Typical applications:

- Specialized circuits
- Industrial control
- Isolated, in-line fuse holders (street lighting)

Catalog numbers (amps)

KTK-R-1/10	KTK-R-1	KTK-R-7
KTK-R-1/8	KTK-R-1-1/2	KTK-R-8
KTK-R-3/10	KTK-R-2	KTK-R-9
KTK-R-1/4	KTK-R-2-1/2	KTK-R-10
KTK-R-3/8	KTK-R-3	KTK-R-12
KTK-R-1/2	KTK-R-3-1/2	KTK-R-15
KTK-R-5/8	KTK-R-4	KTK-R-20
KTK-R-3/4	KTK-R-5	KTK-R-25
KTK-R-1	KTK-R-6	KTK-R-30

Time-current characteristic curves—average melt

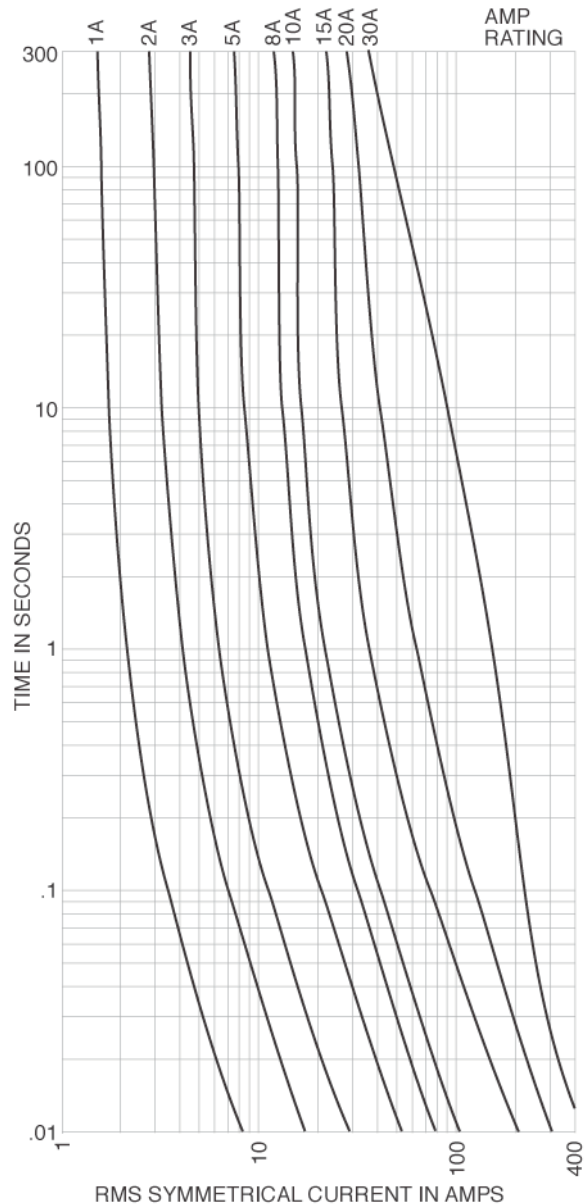

Low voltage
branch circuit
fuses

For superior electrical protection, Eaton recommends upgrading KTK-R fuse applications to Bussmann series Low-Peak LP-CC fuses See page 1-7.

Recommended fuse holders and blocks for Class CC fuses

- See page 1-2

Low voltage, branch circuit fuses

Time-delay Low-Peak CUBEFuse™ finger-safe fuse

TCF 600V Class CF



Specifications:

Description: Finger-safe fuse and fuse holder system; dual-element, time-delay fuse; 10 seconds minimum operating time at 500% rated amps.

Dimensions: See dimensions illustration.

Poles: 1-pole (gangable)

Ratings:

Volts — 600Vac (or less)
— 300Vdc (or less)

Amps — 1-100A

IR — 300kA RMS Sym. (UL)
— 200kA RMS Sym. (CSA)
— 100kA DC (UL and CSA)

Agency information: CE, UL Listed Guide JDDZ, File E4273, CSA Certified Fuse: Class 1422- 02, File 53787, UL Listed Fuse holder: Guide IZND, File E214079, CSA Certified Fuse holder: Class 6225-01, File 47235.

Features and benefits:

- Separate overload and short-circuit elements provide time delay for sizing of high inrush loads linked with Class J current limitation.
- Selective coordination ratio of 2:1 (within Low-Peak fuse family) prevents electrical shutdowns from extending beyond the failed circuit.
- Smallest footprint of any Class CC, J, T or RK fuse provides substantial space savings and installation flexibility.
- IEC 60529 and finger-safe rating provides enhanced workplace safety.

Typical applications:

- Electrical panelboards
- Machinery disconnects
- Industrial control
- Required finger-safe systems

Fuse catalog numbers indicating (amps)

TCF6	TCF25	TCF50	TCF100
TCF10	TCF30	TCF60	
TCF15	TCF35	TCF70	
TCF17-½	TCF40	TCF80	
TCF20	TCF45	TCF90	

Fuse catalog numbers non-indicating (amps)

TCF1RN	TCF17-½RN	TCF40RN	TCF80RN
TCF3RN	TCF20RN	TCF45RN	TCF90RN
TCF6RN	TCF25RN	TCF50RN	TCF100RN
TCF10RN	TCF30RN	TCF60RN	
TCF15RN	TCF35RN	TCF70RN	

Carton quantity and weight

Amp rating	Carton qty.	Weight per carton	
		lbs	kg
1-30A	12	1.39	0.63
35-60A	12	1.42	0.65
70-100A	6	1.74	0.79

Recommended fuse holders for Class CF fuses

- See page 1-16

Data Sheet: 9000 (fuses) and 9007 (holders)

Low voltage, branch circuit fuses

Time-delay Low-Peak CUBEFuse™ finger-safe fuse

Dimensions – in (mm)

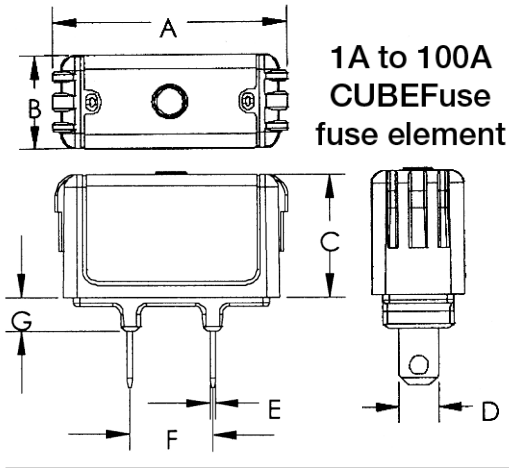

Fuse amps	Dimensions - in (mm)						
	A	B	C	D	E	F	G
1-15	1.88 (47.75)	0.75 (19.05)	1.00 (25.40)	0.23 (5.84)	0.04 (1.02)	0.63 (15.93)	0.28 (7.11)
17 ½	1.88 (47.75)	0.75 (19.05)	1.00 (25.40)	0.31 (7.87)	0.04 (1.02)	0.63 (15.93)	0.28 (7.11)
20	1.88 (47.75)	0.75 (19.05)	1.00 (25.40)	0.31 (7.87)	0.04 (1.02)	0.63 (15.93)	0.28 (7.11)
25-30	1.88 (47.75)	0.75 (19.05)	1.00 (25.40)	0.31 (7.87)	0.04 (1.02)	0.63 (15.93)	0.28 (7.11)
35-40	2.13 (54.10)	1.00 (25.40)	1.13 (28.58)	0.36 (9.10)	0.04 (1.02)	0.63 (15.93)	0.38 (9.65)
45-50	2.13 (54.10)	1.00 (25.40)	1.13 (28.58)	0.44 (11.13)	0.04 (1.02)	0.63 (15.93)	0.38 (9.65)
60	2.13 (54.10)	1.00 (25.40)	1.13 (28.58)	0.44 (11.13)	0.04 (1.02)	0.63 (15.93)	0.38 (9.65)
70	3.01 (76.45)	1.00 (25.40)	1.26 (32.00)	0.49 (12.45)	0.06 (1.60)	0.58 (14.78)	0.38 (9.65)
80-90	3.01 (76.45)	1.00 (25.40)	1.26 (32.00)	0.49 (12.45)	0.06 (1.60)	0.58 (14.78)	0.38 (9.65)
100	3.01 (76.45)	1.00 (25.40)	1.26 (32.00)	0.57 (14.48)	0.06 (1.60)	0.58 (14.78)	0.38 (9.65)

Current limitation curves

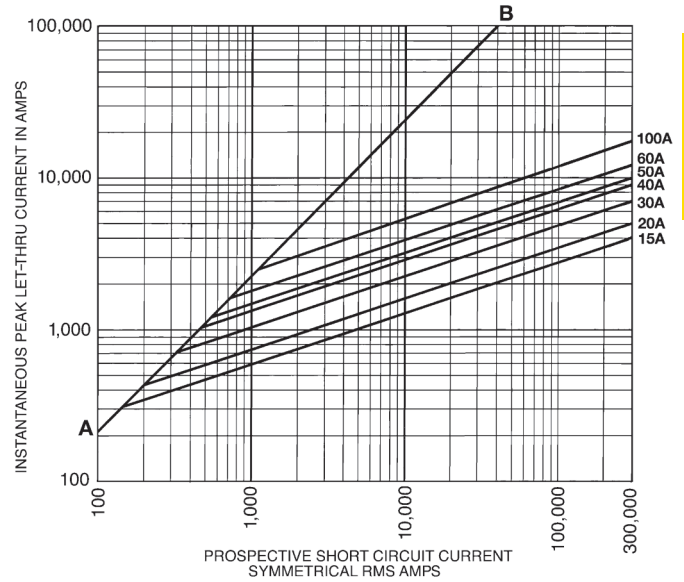

Low voltage branch circuit fuses

Time-current characteristic curves—average melt

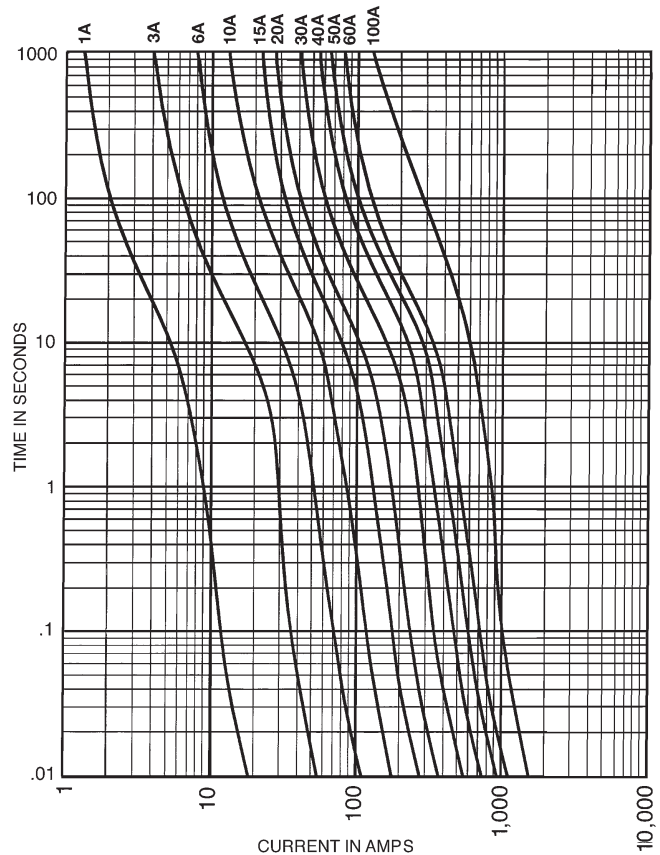

Low voltage, branch circuit fuses

UPS and critical application fast-acting CUBEFuse™ finger-safe fuse

Low voltage
branch circuit
fuses

Dimensions - in (mm)

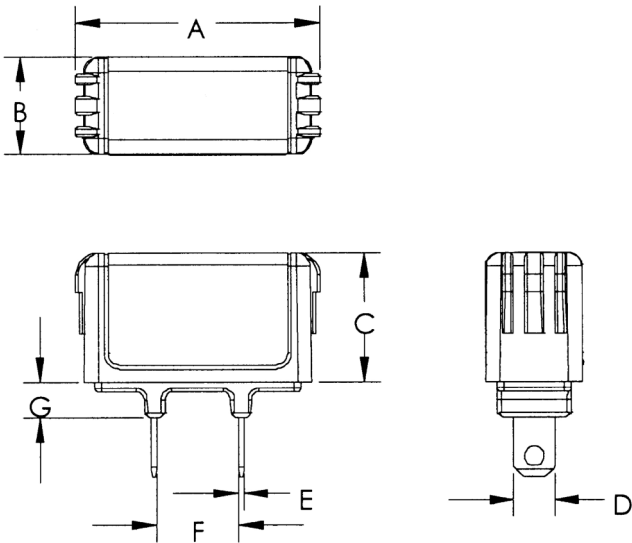

Fuse amps	Dimensions - in (mm)						
	A	B	C	D	E	F	G
1-15	1.88 (47.75)	0.75 (19.05)	1.00 (25.40)	0.23 (5.84)	0.04 (1.02)	0.63 (15.93)	0.28 (7.11)
20	1.88 (47.75)	0.75 (19.05)	1.00 (25.40)	0.31 (7.87)	0.04 (1.02)	0.63 (15.93)	0.28 (7.11)
25-30	1.88 (47.75)	0.75 (19.05)	1.00 (25.40)	0.31 (7.87)	0.04 (1.02)	0.63 (15.93)	0.28 (7.11)
35-40	2.13 (54.10)	1.00 (25.40)	1.13 (28.58)	0.36 (9.10)	0.04 (1.02)	0.63 (15.93)	0.38 (9.65)
45-50	2.13 (54.10)	1.00 (25.40)	1.13 (28.58)	0.44 (11.13)	0.04 (1.02)	0.63 (15.93)	0.38 (9.65)
60	2.13 (54.10)	1.00 (25.40)	1.13 (28.58)	0.44 (11.13)	0.04 (1.02)	0.63 (15.93)	0.38 (9.65)
70	3.01 (76.45)	1.00 (25.40)	1.26 (32.00)	0.49 (12.45)	0.06 (1.60)	0.58 (14.78)	0.38 (9.65)
80-90	3.01 (76.45)	1.00 (25.40)	1.26 (32.00)	0.49 (12.45)	0.06 (1.60)	0.58 (14.78)	0.38 (9.65)
100	3.01 (76.45)	1.00 (25.40)	1.26 (32.00)	0.57 (14.48)	0.06 (1.60)	0.58 (14.78)	0.38 (9.65)

Current limitation curves

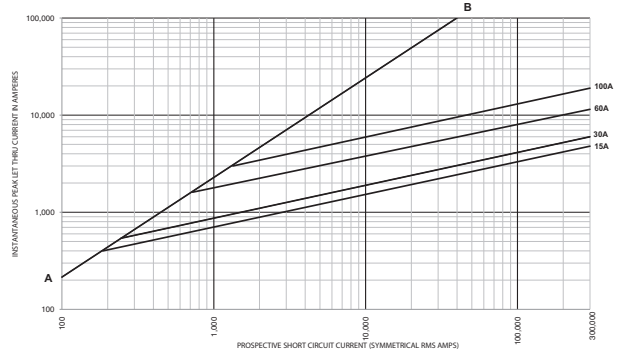

Time-current characteristic curves-average melt

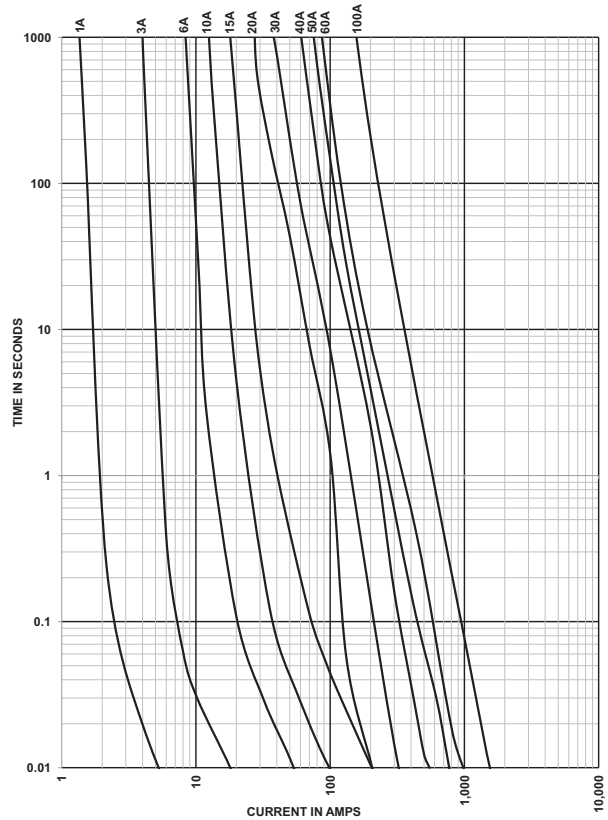

Low voltage, branch circuit fuses

Wind fast-acting CUBEFuse™ – finger-safe fuse

WCF 690V



Catalog Symbol: WCF_RN

Description: Finger-safe, fast-acting CUBEFuse for wind power generation.

Electrical characteristics: Maximum clearing time at 200% rated current:

- 4 minutes for 1 to 30A fuses
- 6 minutes for 35 to 60A fuses
- 8 minutes for 70 to 100A fuses

Ratings:

Volts — 690Vac

Amps — 1-100A

IR — 50kA AC (1-60A)

IR — 30kA AC (70-100A)

Agency information:

- UL Recognized Fuse: Guide JFHR, File E56412
- cURus component certified C22.2
- CE compliance for the European Union low voltage directive

Other ratings/specifications:

Watts loss at rated current:

WCF15RN:	3.48W
WCF30RN:	5.45W
WCF60RN:	7.27W
WCF100RN:	11.50W

Operating and storage temperature range: -40 to 90°C

Material specifications:

- Case: glass filled PES (Polyethersulfone)
- Terminals: copper alloy
- Terminal plating: electroless tin

Installation:

Fits 690V WCF holders. See page 1-16

Application:

- Wind systems:
 - Transformer protection
 - Pitch and speed control
 - Turbine HVAC and lighting

Features and benefits:

- Maximize uptime and reliability using fuses designed and listed to UL 248-1.
- Minimize chances of equipment failure and personnel injury when using full range fuses having the industry's fastest response time to low-magnitude faults.
- Maximize return on investment with fuses proven to withstand harsh temperatures.
- Minimize design time, operating outage time and replacement cost with fuses qualified in excessively changing environmental conditions.
- Simplify compatibility with readily available industry standard holders.
- Temperature derating: Designed to maximize rated capacity in elevated environmental temperatures.
- Overload protection: Proven to clear faults faster than the UL requirement.
- Power loss: Minimal energy consumption leading to increased efficiency.

Catalog numbers (amp rating)

Non-indicating wind CUBEFuse				
WCF1RN	WCF15RN	WCF35RN	WCF60RN	WCF100RN
WCF3RN	WCF20RN	WCF40RN	WCF70RN	—
WCF6RN	WCF25RN	WCF45RN	WCF80RN	—
WCF10RN	WCF30RN	WCF50RN	WCF90RN	—

Carton quantity and weight

Amp rating	Carton qty.	Weight per carton	
		lbs	kg
1-30A	12	1.39	0.63
35-60A	12	1.42	0.65
70-100A	6	1.74	0.79

Recommended fuse holders for Class CF fuses

- See page 1-16

Data Sheet: 9009

Low voltage, branch circuit fuses

Wind fast-acting CUBEFuse™ – finger-safe fuse

Low voltage
branch circuit
fuses

Dimensions – in (mm)

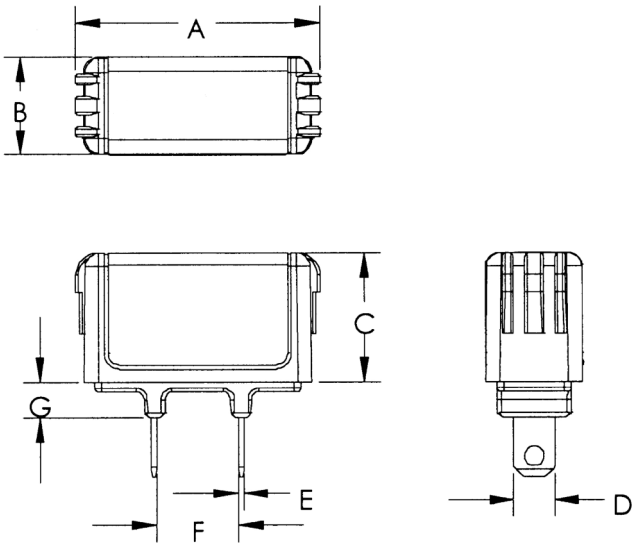

Fuse Amps	Dimensions - in (mm)						
	A	B	C	D	E	F	G
1-15	1.88 (47.75)	0.75 (19.05)	1.00 (25.40)	0.23 (5.84)	0.04 (1.02)	0.63 (15.93)	0.28 (7.11)
20	1.88 (47.75)	0.75 (19.05)	1.00 (25.40)	0.31 (7.87)	0.04 (1.02)	0.63 (15.93)	0.28 (7.11)
25-30	1.88 (47.75)	0.75 (19.05)	1.00 (25.40)	0.31 (7.87)	0.04 (1.02)	0.63 (15.93)	0.28 (7.11)
35-40	2.13 (54.10)	1.00 (25.40)	1.13 (28.58)	0.36 (9.10)	0.04 (1.02)	0.63 (15.93)	0.38 (9.65)
45-50	2.13 (54.10)	1.00 (25.40)	1.13 (28.58)	0.44 (11.13)	0.04 (1.02)	0.63 (15.93)	0.38 (9.65)
60	2.13 (54.10)	1.00 (25.40)	1.13 (28.58)	0.44 (11.13)	0.04 (1.02)	0.63 (15.93)	0.38 (9.65)
70	3.01 (76.45)	1.00 (25.40)	1.26 (32.00)	0.49 (12.45)	0.06 (1.60)	0.58 (14.78)	0.38 (9.65)
80-90	3.01 (76.45)	1.00 (25.40)	1.26 (32.00)	0.49 (12.45)	0.06 (1.60)	0.58 (14.78)	0.38 (9.65)
100	3.01 (76.45)	1.00 (25.40)	1.26 (32.00)	0.57 (14.48)	0.06 (1.60)	0.58 (14.78)	0.38 (9.65)

Current limitation curves

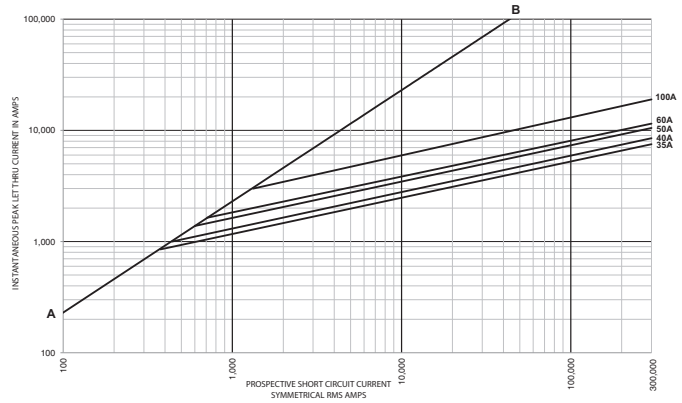

Time-current characteristic curves—average melt

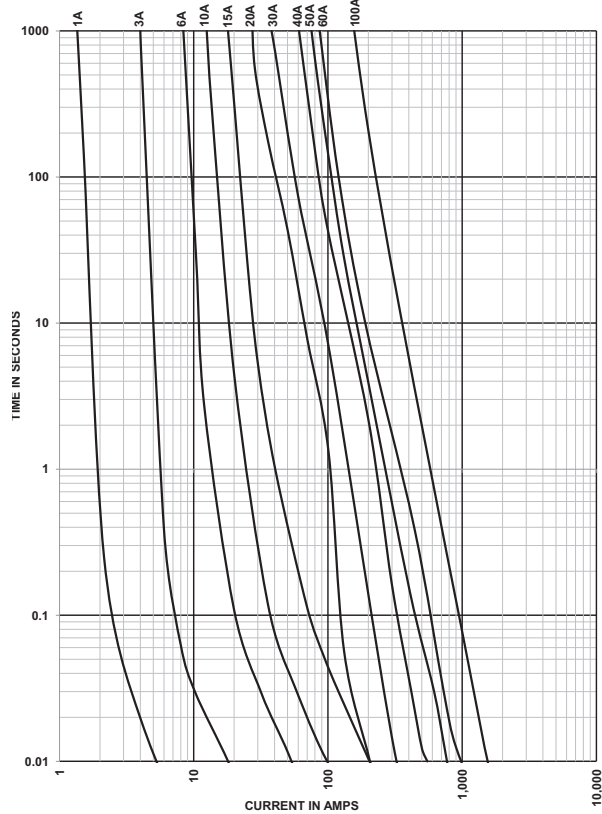

CUBEFuse fuse holders

Catalog symbols:

600V	690V (Wind)	Ampacity (holds any CUBEFuse)
TCFH30N	TCFH30NW	(1-30A)
TCFH60N	TCFH60NW	(1-60A)
TCFH100N	TCFH100NW	(1-100A)

Construction: Finger-safe

Mounting: 35mm DIN-Rail or panel mount

Ratings:

Volts: 600V (UL, CSA)
690V (cURus - Wind version)†

Withstand rating: 300kA RMS Sym. (UL)
200kA RMS Sym. (CSA)
100kA DC (UL and CSA)
50kA AC (cURus, 1-60A Wind version)

Agency information:

- UL Listed fuse holder: Guide IZLT, File E14853
- CSA Certified fuse holder: Class 6225-01, File 47235
- cURus component Certified
- CE compliance for the European Union low voltage directive

†690 self certified.



Operating and storage temperature range:
-40 to 80°C

Material specifications:

- Holder case: glass filled PBT
- Interface clips: copper alloy
- Interface clip plating: tin
- Terminals: steel
- DIN-Rail spring: stainless steel

CUBEFuse™ holder applications

CUBEFuse holder catalog number	Volts	CUBEFuse type and ampacity range per CUBEFuse holder				
		Non-indicating time-delay TCF_RN	Indicating time-delay TCF_	Fast-acting FCF_RN	Photovoltaic PVCF_RN	Wind WCF_RN
TCFH30N	600	1-30	6-30	1-30	—	—
TCFH60N	600	1-60	6-60	1-60	35-60	—
TCFH100N	600	1-100	6-100	1-100	35-100	—
TCFH30NW	690	—	—	—	—	1-30
TCFH60NW	690	—	—	—	—	1-60
TCFH100NW	690	—	—	—	—	1-100

Terminal torque ratings by conductor and holder size (75°C Cu only)

TCFH30N / TCFH30NW		TCFH60N / TCFH60NW		TCFH100N / TCFH100NW	
Single	Dual	Single	Dual	Single	Dual
10-8AWG 25Lb-In	18-10AWG 25Lb-In*	14-10AWG 20Lb-In	18-10AWG 20Lb-In	18-10AWG 25Lb-In**	6AWG 45Lb-In†
18-12AWG 20Lb-In		8-4AWG 35Lb-In	8-6AWG 35Lb-In	8-1AWG 40Lb-In†	

* 18-10AWG stranded, 14-18AWG solid

** Solid and stranded

† Stranded

Dimensions - in (mm)

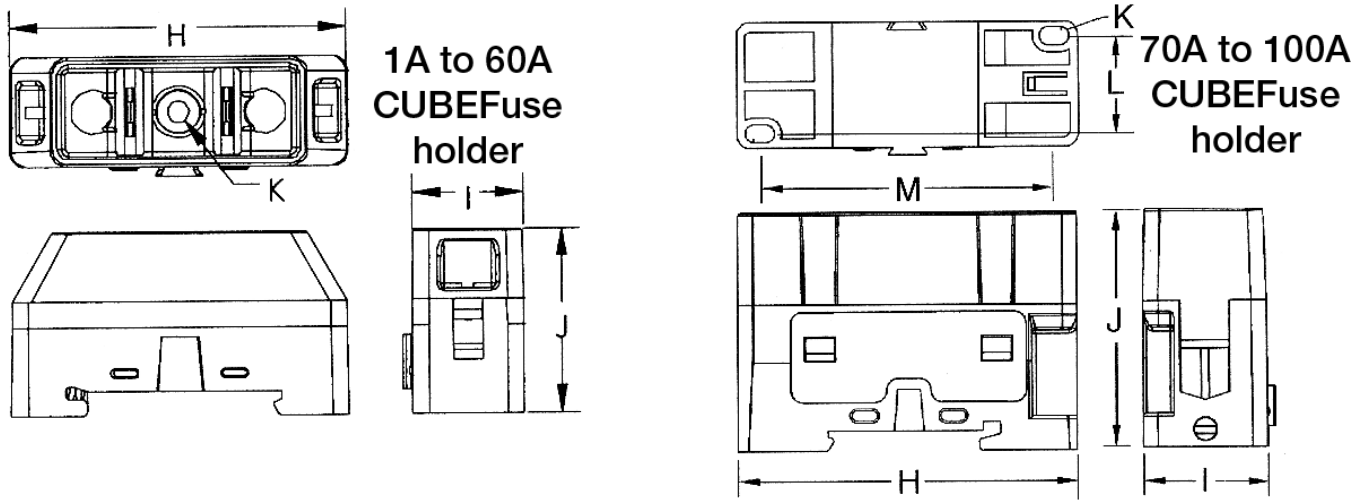

CUBEFuse™ holder catalog numbers

Catalog number	CUBEFuse amp range	Wire range (Cu/AWG)		Dimensions - in (mm)					
		Single	Dual	H	I	J	K	L	M
TCFH30N TCFH30NW	1-30	14-8	14-10	2.30 (58.5)	0.76 (19.37)	1.36 (34.24)	0.15 (3.76)	—	—
TCFH60N TCFH60NW	1-60	14-4	10-6	2.60 (66.12)	1.03 (26.23)	1.60 (40.64)	0.17 (4.34)	—	—
TCFH100N TCFH100NW	1-100	10-1	6	2.91 (73.81)	1.05 (26.74)	2.01 (50.93)	0.15 (3.81)	0.80 (20.39)	2.51 (63.65)

SC Class G

Specifications:

Description: Fast-acting ($\frac{1}{2}$ -6A), time-delay (7-60A) fuse.

Dimensions: See dimensions illustration.

Ratings:

- Volts — 600Vac ($\frac{1}{2}$ -20A)
- 480Vac (25-60A)
- 170Vdc ($\frac{1}{2}$ -20A)
- 300Vdc (30 and 60A only)

Amps — $\frac{1}{2}$ -60A

- IR — 100kA RMS Sym.
- 10kA DC



Agency information: CE, Std. 248-5, Class G, UL Listed, Guide JDDZ, File E4273, CSA Certified, Class 1422-01, File 53787, RoHS compliant.

Features and benefits:

- Current limiting for component protection, providing Class G energy-limitation for branch circuit protection.
- 100kA interrupting rating provides cost-effective branch circuit fusing.
- Variations in length help prevent overfusing.

Typical applications:

- Fusible branch panelboards
- HVAC branch circuit protection

Catalog numbers (amps)

SC- $\frac{1}{2}$	SC-2- $\frac{1}{2}$	SC-6	SC-12	SC-30	SC-50
SC-1	SC-3	SC-7	SC-15	SC-35	SC-60
SC-1- $\frac{1}{2}$	SC-4	SC-8	SC-20	SC-40	
SC-2	SC-5	SC-10	SC-25	SC-45	

Dimensions -in (mm)

Fuse amps	Length	Diameter
$\frac{1}{2}$ to -15	1.31 (33.3)	0.41" (10.4)
20	1.41 (35.8)	0.41" (10.4)
25 to -30	1.62 (41.2)	0.41" (10.4)
35 to -60	2.25 (57.1)	0.41" (10.4)

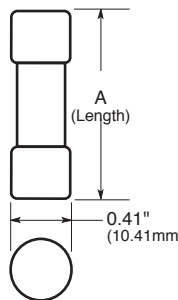

Time-current characteristic curves—average melt

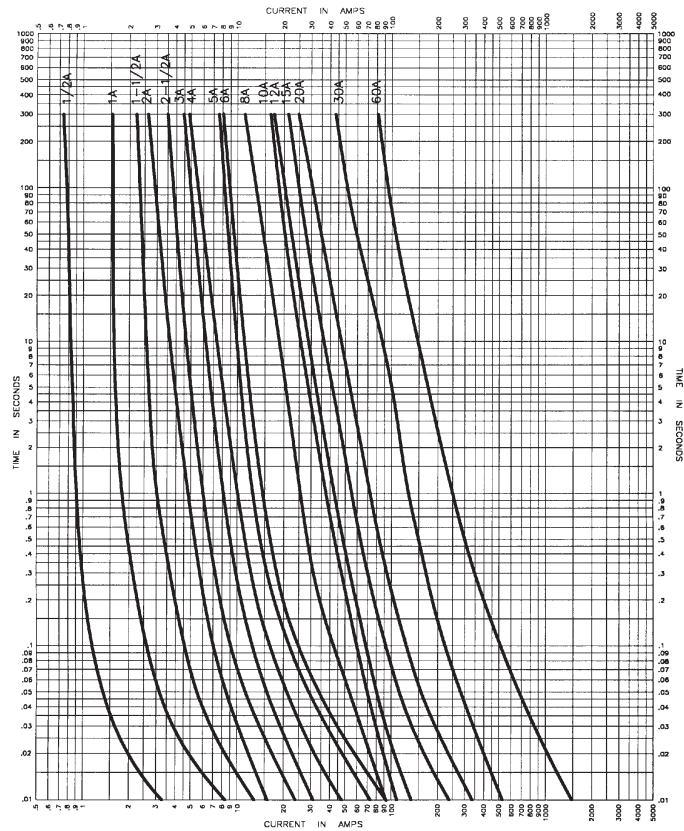

Current limitation curves

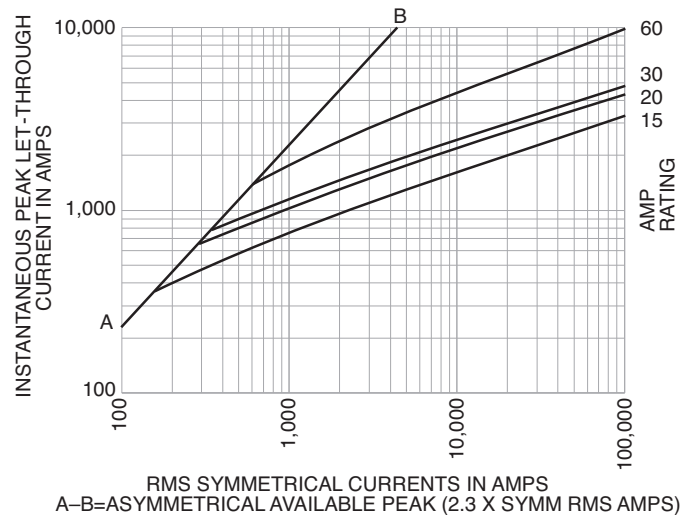

Recommended fuse holders and blocks for Class G fuses

- See page 1-2

LPJ_SP Class J

Available with indication



Specifications:

Description:

Dual-element, time-delay fuse; 10 seconds (minimum) at 500% rated amps. Now available with optional indication on select ratings (see catalog numbers table).

Dimensions: See page 1-5 for Class J dimensions.

Ratings:

- Volts — 600Vac (or less)
- 300Vdc (or less)
- Amps — 1-600A
- IR — 300kA RMS Sym.
- 100kA DC



Agency information: CE, UL Listed, Guide JFHR, File E56412, CSA Certified (200k AIR) Class J per CSA-22.2 No. 248.8, Class 1422-02, File 53787, RoHS compliant.

Features and benefits:

- Separate overload and short-circuit elements provide time delay for sizing of high inrush loads linked with Class J current limitation.
- Selective coordination ratio of 2:1 (within Low-Peak fuse family) prevents electrical shutdowns from extending beyond the failed circuit.
- Series combination ratings with branch circuit breakers allows broad range of coverage, independent of breaker manufacturer.

Typical applications:

- Power panelboards
- Branch circuit breaker panelboard mains
- Machinery disconnects
- Industrial control

Catalog numbers (amps)

LPJ-1SP	LPJ-4-½SP	LPJ-25SP*	LPJ-125SP*
LPJ-1-¼SP	LPJ-5SP	LPJ-30SP*	LPJ-150SP*
LPJ-1-⅝SP	LPJ-5-⅝SP	LPJ-35SP*	LPJ-175SP*
LPJ-1-¾SP	LPJ-6SP*	LPJ-40SP*	LPJ-200SP*
LPJ-2SP	LPJ-7SP*	LPJ-45SP*	LPJ-225SP*
LPJ-2-¼SP	LPJ-8SP*	LPJ-50SP*	LPJ-250SP*
LPJ-2-½SP	LPJ-9SP*	LPJ-60SP*	LPJ-300SP*
LPJ-2-⅝SP	LPJ-10SP*	LPJ-70SP*	LPJ-350SP*
LPJ-3SP	LPJ-12SP*	LPJ-80SP*	LPJ-400SP*
LPJ-3-¼SP	LPJ-15SP*	LPJ-90SP*	LPJ-450SP*
LPJ-3-½SP	LPJ-17-½SP*	LPJ-100SP*	LPJ-500SP*
LPJ-4SP	LPJ-20SP*	LPJ-110SP*	LPJ-600SP*

*Available with optional permanent replace fuse indication. To order, place "I" at end of catalog number. Example: LPJ-6SPI.

Available with silver plated terminals. Add SP/ in front of catalog number.

Time-current characteristic curves—average melt

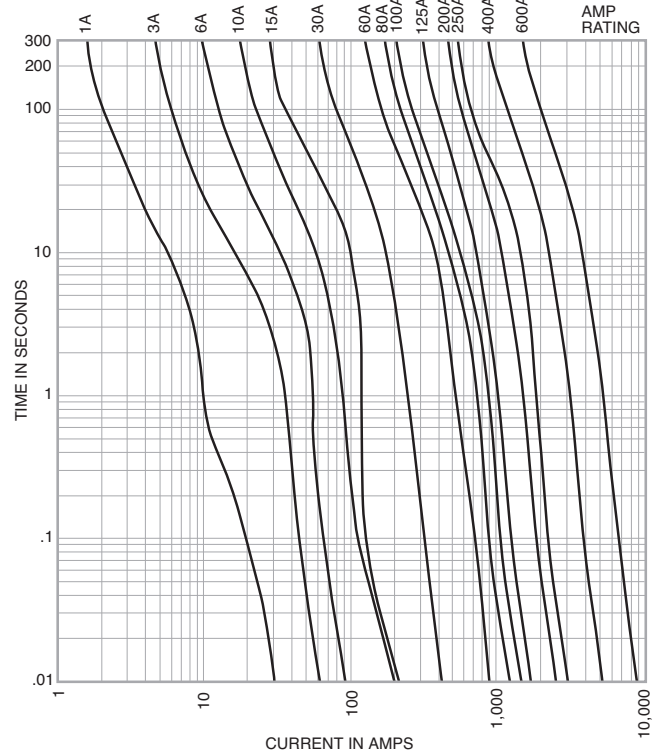

Low voltage branch circuit fuses

Current limitation curves

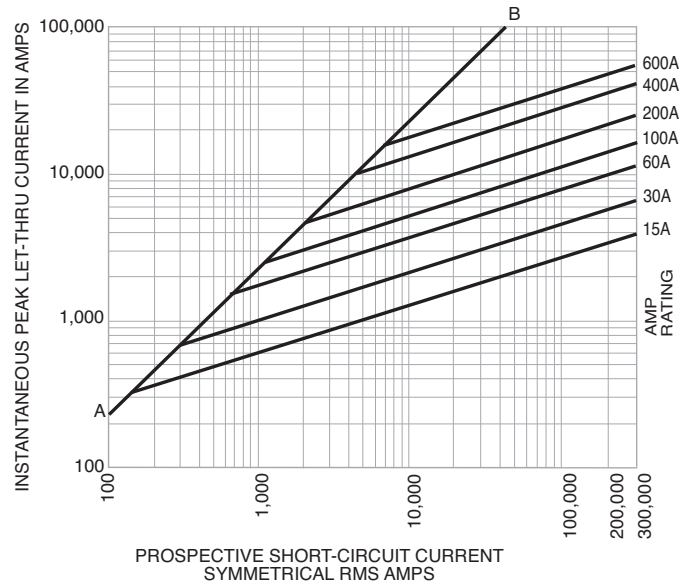

Data Sheets: 1006 (0-60) and 1007 (70-600)

Recommended fuse holders and blocks for Class J fuses
• See page 1-4

1

Low voltage, branch circuit fuses

Limitron™ fast-acting fuses

JKS Class J

Specifications:

Description: Fast-acting, current-limiting fuse.

Dimensions: See page 1-5 for Class J dimensions.

Ratings:

Volts — 600Vac (or less)

Amps — 1-600A

IR — 200kA RMS Sym.

Agency information: CE, Std.

248-8, Class J, UL Listed, Guide

JDDZ, File E4273, CSA Certified, Class 1422-02,

File 53787.



Features and benefits:

- Current limitation for non-inductive circuits provides Class J current-limiting response to maximum ground fault and short-circuit conditions.
- 200kA interrupting rating provides high ratings at all circuit locations.
- Economical solutions for high-fault circuits.

Typical applications:

- Power panelboards
- Machinery disconnects

Catalog numbers (amps)

JKS-1	JKS-15	JKS-70	JKS-225
JKS-2	JKS-20	JKS-80	JKS-250
JKS-3	JKS-25	JKS-90	JKS-300
JKS-4	JKS-30	JKS-100	JKS-350
JKS-5	JKS-35	JKS-110	JKS-400
JKS-6	JKS-40	JKS-125	JKS-450
JKS-8	JKS-45	JKS-150	JKS-500
JKS-10	JKS-50	JKS-175	JKS-600
JKS-12	JKS-60	JKS-200	

For superior electrical protection, Eaton recommends upgrading JKS fuse applications to Bussmann series Low-Peak LPJ fuses See page 1-19.

Recommended fuse holders and blocks for Class J fuses

- See page 1-4

Time-current characteristic curves—average melt

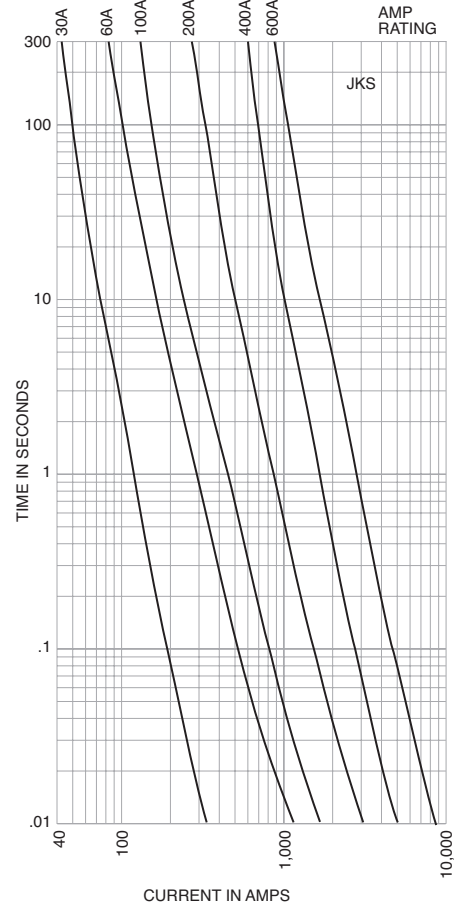

Current limitation curves

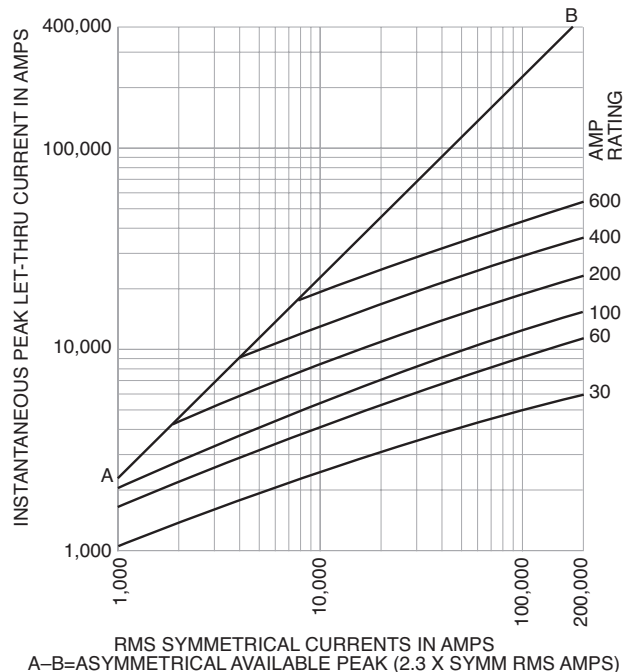

Data Sheet: 1026 (1-60) and 1027 (70-600)

NON (250Vac) Class K5 and H

NOS (600Vac) Class K5 and H

Specifications:

Description: General purpose, non-current-limiting fuses.

Dimensions: See page 1-5 for dimensions.

Ratings:

Volts — **NON:**

- 250Vac
- 125Vdc (0-100A)

- **NOS:**
- 600Vac

Amps — 1/8-600A

- IR — 50kA RMS Sym. (NON and NOS Class K5 0-60A)
- 10kA RMS Sym. (NON and NOS Class H 65-600A)
- 50kA @ 125Vdc (NON Class K5 0-60A)
- 10kA @ 125Vdc (NON Class H 65-100A)

Agency information: CE, UL Listed – 250V: Class K5 (0-60A), Std. 248-9, Class H (65-600A), Std. 248-6, (125Vdc: NON 0-100), 600V: Class K5 (0-60A), Std. 248-9, Class H (70-600A), Std. 248-6, Guide JDDZ, File E4273, CSA Certified – 250V: (0-12, 65-600)†, 600V: (0-600), Class 1421-01, File 53787.

† For CSA Certified 15-60A ratings, see PON on page 7-3.

Features and benefits:

- Basic overcurrent protection.

Typical applications:

- Light duty circuit locations



NOS (600Vac) catalog numbers (amps)

NOS-1	NOS-12	NOS-70	NOS-200
NOS-2	NOS-15	NOS-75	NOS-225
NOS-3	NOS-20	NOS-80	NOS-250
NOS-4	NOS-25	NOS-90	NOS-300
NOS-5	NOS-30	NOS-100	NOS-350
NOS-6	NOS-35	NOS-110	NOS-400
NOS-7	NOS-40	NOS-125	NOS-450
NOS-8	NOS-45	NOS-150	NOS-500
NOS-9	NOS-50	NOS-175	NOS-600
NOS-10	NOS-60		

Recommended fuse reducers

250V Fuse amp size	Clip amp size	Catalog number (pair)	600V Fuse amp size	Clip amp size	Catalog number (pair)
30	60	NO.263	30	60	NO.663
30	100	NO.213	30	100	NO.216
60	100	NO.216	60	100	NO.616
60	200	NO.226	60	200	NO.626
100	200	NO.2621	100	200	NO.2621
100	400	NO.2641	100	400	NO.2641
200	400	NO.2642	200	400	NO.2642
100	600	NO.2661	100	600	NO.2661
200	600	NO.2662	200	600	NO.2662
400	600	NO.2664	400	600	NO.2664

NON (250Vac) catalog numbers (amps)

NON-1/8	NON-5	NON-40	NON-175
NON-1/4	NON-6	NON-45	NON-200
NON-3/8	NON-6-1/4	NON-50	NON-225
NON-1/2	NON-7	NON-60	NON-250
NON-1	NON-8	NON-65	NON-300
NON-1-1/4	NON-9	NON-70	NON-350
NON-1-1/2	NON-10	NON-75	NON-400
NON-1-3/4	NON-12	NON-80	NON-450
NON-2	NON-15	NON-90	NON-500
NON-2-1/2	NON-20	NON-100	NON-600
NON-3	NON-25	NON-110	
NON-3-1/2	NON-30	NON-125	
NON-4	NON-35	NON-150	

For superior electrical protection, Eaton recommends upgrading NON (250Vac) and NOS (600Vac) fuse applications to Bussmann series Low-Peak LPN-RK (250Vac) and LPS-RK (600Vac) fuses See page 1-25.

Recommended fuse holders and blocks for Class K5 and H 250V and 600V fuses

- See page 1-2

1

Low voltage, branch circuit fuses

Low-Peak™ time-delay fuses

KRP-C_SP Class L

Specifications:

Description: Time-delay fuse – 4 seconds (minimum) at 500% rated amps.

Dimensions: See page 1-6 for Class L dimensions.

Ratings:

- Volts — 600Vac (or less)
- 300Vdc (601-2000A, 3000A)
- Amps — 601-6000A
- (use KRP-CL for current ratings under 601A)
- IR — 300kA RMS Sym.
- 100kA DC

Agency information: CE, UL Listed-248-10, Guide JFHR, File E56412, CSA Certified (200k AIR), Class 1422-02, File 53787, Class L per CSA C22.2, No. 248.10, RoHS compliant.



Features and benefits:

- Time-delay of four seconds at five times rating allows closer sizing on large motor loads combined with Class L current limitation.
- Selective coordination ratio of 2:1 (within Low-Peak fuse family) prevents electrical shutdowns from extending beyond the failed circuit.
- Interrupting rating of 300kA RMS symmetrical provides adequate ratings without obsolescence for all electrical systems, big or small.
- Quality construction, using high-grade materials, provides lower watts loss and operating temperatures with superior arc quenching during current-limiting action.

Typical applications:

- Large distribution switchboards
- Power panelboards
- Large machinery disconnects

Catalog numbers (amps)

KRP-C-601SP	KRP-C-1000SP	KRP-C-1800SP	KRP-C-3500SP
KRP-C-650SP	KRP-C-1100SP	KRP-C-1900SP	KRP-C-4000SP
KRP-C-700SP	KRP-C-1200SP	KRP-C-2000SP	KRP-C-4500SP
KRP-C-750SP	KRP-C-1350SP	KRP-C-2001SP	KRP-C-5000SP
KRP-C-800SP	KRP-C-1400SP	KRP-C-2400SP	KRP-C-6000SP
KRP-C-801SP	KRP-C-1500SP	KRP-C-2500SP	
KRP-C-900SP	KRP-C-1600SP	KRP-C-3000SP	

Data Sheets: 1008 and 1009

Recommended fuse holders and blocks for Class L fuses

- See page 1-3

Time-current characteristic curves—average melt

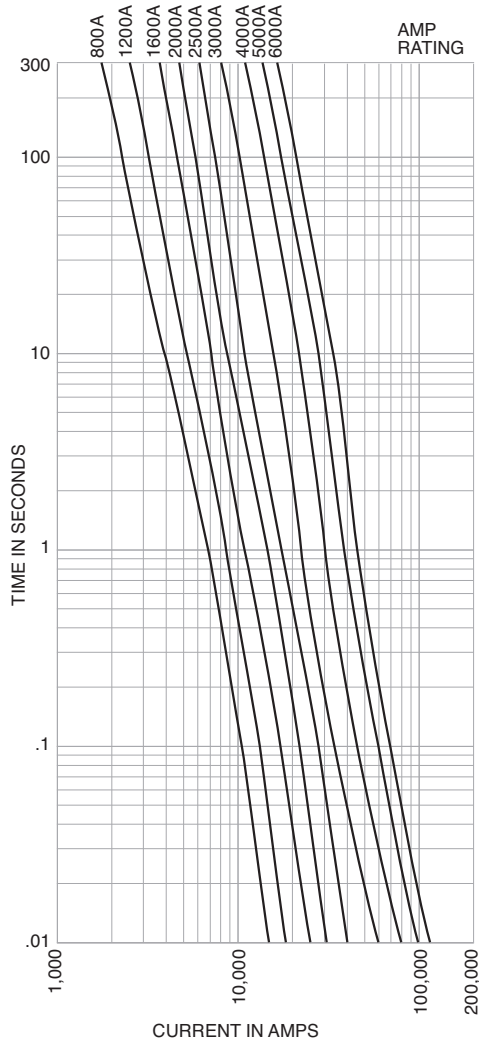

Current limitation curves

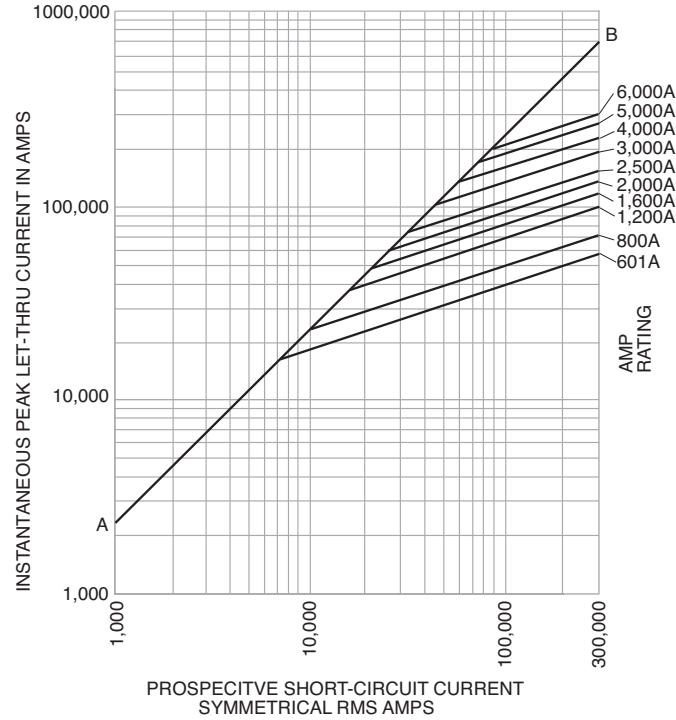

Data Sheets: 1008 and 1009

KRP-CL current-limiting, time-delay fuses

Specifications:

Description: Current-limiting, time-delay fuse.

Dimensions: See page 1-6 for Class L dimensions.

Ratings:

- Volts — 600Vac (or less)
- Amps — 225-600A
- IR — 200kA RMS Sym.

Features and benefits:

- Time-delay of four seconds at five times rating allows closer sizing inductive loads coupled with an equivalent Class L current limitation.

- Class L case size for amp ratings from 225 to 600A allows downsize fusing of large Class L fused switches for improved circuit protection.

Typical applications:

- Large distribution switchboards
- Power panelboards
- Machinery disconnects

Catalog numbers (amps)

KRP-CL-225	KRP-CL-350	KRP-CL-500
KRP-CL-250	KRP-CL-400	KRP-CL-600
KRP-CL-300	KRP-CL-450	

Data Sheet: 1016

Recommended fuse holders and blocks for Class L fuses
• See page 1-3

1

Low voltage, branch circuit fuses

Limitron™ fuses

KTU Class L

Specifications:

Description: Fast-acting, bolt-mount fuse.

Dimensions: See page 1-6 for Class L dimensions.

Ratings:

- Volts — 600Vac (or less)
- Amps — 601-6000A
- IR — 200kA RMS Sym.

Agency information: CE, Std. 248-10, Class L, UL Listed, Guide JDDZ, File E4273 CSA Certified, Class 1422-02, File 53787, RoHS compliant.

Features and benefits:

- 200kA interrupting rating provides high ratings at all circuit locations.
- Economical solutions for high-fault circuits.
- Quality construction using high-grade materials provides lower watts loss and operating temperatures with superior arc quenching during current-limiting action.

Typical applications:

- Large distribution switchboards
- Power panelboards

Catalog numbers (amps)

KTU-601	KTU-1000	KTU-2001
KTU-650	KTU-1100	KTU-2400
KTU-700	KTU-1200	KTU-2500
KTU-750	KTU-1400	KTU-3000
KTU-800	KTU-1500	KTU-3500
KTU-801	KTU-1600	KTU-4000
KTU-850	KTU-1800	KTU-5000
KTU-900	KTU-2000	KTU-6000



KLU Class L

Specifications:

Description: Time-delay, bolt-mount fuse - 5 seconds (minimum) at 500% rated amps. See KRP-CL for amp ratings below 601A.

Dimensions: See page 1-6 for Class L dimensions.

Ratings:

- Volts — 600Vac (or less)
- Amps — 601-4000A
- IR — 200kA RMS Sym.

Agency information: CE, Std. 248-10, Class L, UL Listed, Guide JDDZ, File E4273, CSA Certified, CSA Class 1422-02, File 53787, RoHS compliant.

Features and benefits:

- 200kA interrupting rating provides high ratings at all circuit locations.
- Economical solutions for high fault circuits.

Typical applications:

- Large distribution switchboards
- Power panelboards
- Large machinery disconnects

Catalog numbers (amps)

KLU-601	KLU-1200	KLU-2500
KLU-650	KLU-1500	KLU-3000
KLU-700	KLU-1600	KLU-4000
KLU-800	KLU-1800	
KLU-1000	KLU-2000	



For superior electrical protection, Eaton recommends upgrading KTU fuse applications to Bussmann series Low-Peak KRP-C fuses See page 1-22.

Recommended fuse holders and blocks for Class L fuses

- See page 1-3

For superior electrical protection, Eaton recommends upgrading KLU fuse applications to Bussmann series Low-Peak KRP-C fuses See page 1-22.

Recommended fuse holders and blocks for Class L fuses

- See page 1-3

LPN-RK_SP (250V) Class RK1

LPS-RK_SP (600V) Class RK1

Available with
indication



Specifications:

Description:

Current-limiting, dual-element, time-delay fuse; 10 seconds (minimum) at 500% rated amps (8 seconds for 0-30A sizes). Now available with optional indication on select ratings (see catalog numbers table).

Dimensions: See page 1-5 for Class RK1 dimensions.

Ratings:

Volts **LPN-RK:**

- 250Vac (or less)
- 125Vdc (0-60A)
- 250Vdc (70-600A)

LPS-RK:

- 600Vac (or less)
- 300Vdc

Amps — 1/10-600A

- IR — 300kA RMS Sym.
- 100kA DC

Agency information: CE, UL Listed, Guide JFHR, File E56412, CSA Certified (200k AIR), Class RK1 per CSA C22.2, No. 248.12, Class 1422-02, File 53787.

Features and benefits:

- Separate overload and short-circuit elements provide time delay for close sizing of high inrush loads linked with RK1 current-limitation and selective coordination ratio of 2:1 (within Low-Peak fuse family) helps prevent widespread blackouts.
- Inventory consolidation of Class RK1, RK5 and H fuses for reduced SKU investment and minimizing potential for misapplying fuse.
- 300kA RMS symmetrical interrupting rating provides adequate ratings without obsolescence for all electrical systems, big or small.
- Insulated end caps reduces exposure to live parts and extends air gap to distance between blades of adjacent mounted fuses or to housing.

Typical applications:

- Large distribution switchboards
- Power panelboards
- Motor control centers
- Machinery disconnect switches

LPN catalog numbers (amps)

LPN-RK-1/10SP	LPN-RK-3-1/2SP	LPN-RK-60SP*
LPN-RK-1/20SP	LPN-RK-4SP	LPN-RK-70SP*
LPN-RK-1/30SP	LPN-RK-4-1/2SP	LPN-RK-80SP*
LPN-RK-1/40SP	LPN-RK-5SP	LPN-RK-90SP*
LPN-RK-1/50SP	LPN-RK-5-1/2SP	LPN-RK-100SP*
LPN-RK-1/60SP	LPN-RK-6SP	LPN-RK-110SP*
LPN-RK-1/70SP	LPN-RK-6-1/2SP	LPN-RK-125SP*
LPN-RK-1/80SP	LPN-RK-8SP	LPN-RK-150SP*
LPN-RK-1SP	LPN-RK-9SP	LPN-RK-175SP*
LPN-RK-1-1/2SP	LPN-RK-10SP	LPN-RK-200SP*
LPN-RK-1-1/4SP	LPN-RK-12SP	LPN-RK-225SP*
LPN-RK-1-1/3SP	LPN-RK-15SP	LPN-RK-250SP*
LPN-RK-1-1/2SP	LPN-RK-17-1/2SP	LPN-RK-300SP*
LPN-RK-1-1/4SP	LPN-RK-20SP	LPN-RK-350SP*
LPN-RK-2SP	LPN-RK-25SP	LPN-RK-400SP*
LPN-RK-2-1/2SP	LPN-RK-30SP	LPN-RK-450SP*
LPN-RK-2-1/4SP	LPN-RK-35SP*	LPN-RK-500SP*
LPN-RK-2-1/3SP	LPN-RK-40SP*	LPN-RK-600SP*
LPN-RK-3SP	LPN-RK-45SP*	
LPN-RK-3-1/2SP	LPN-RK-50SP*	

*Available with optional indication. To order, place "I" at end of catalog number. Example: LPN-RK-35SP_I.
0-60A fuses available with Nickel plate option. (Ex: LPS-RK30SPNP) 70-600A fuses available with Tin plate option. Example: LPS-RK-100SP-TP.

LPS catalog numbers - (amps)

LPS-RK-1/10SP	LPS-RK-2-1/2SP	LPS-RK-10SP*	LPS-RK-100SP*
LPS-RK-1/20SP	LPS-RK-2-1/4SP	LPS-RK-12SP*	LPS-RK-110SP*
LPS-RK-1/30SP	LPS-RK-2-1/3SP	LPS-RK-15SP*	LPS-RK-125SP*
LPS-RK-1/40SP	LPS-RK-3SP	LPS-RK-17-1/2SP*	LPS-RK-150SP*
LPS-RK-1/50SP	LPS-RK-3-1/2SP	LPS-RK-20SP*	LPS-RK-175SP*
LPS-RK-1/60SP	LPS-RK-3-1/4SP	LPS-RK-25SP*	LPS-RK-200SP*
LPS-RK-1/70SP	LPS-RK-4SP	LPS-RK-30SP*	LPS-RK-225SP*
LPS-RK-1SP	LPS-RK-4-1/2SP	LPS-RK-35SP*	LPS-RK-250SP*
LPS-RK-1-1/2SP	LPS-RK-5SP	LPS-RK-40SP*	LPS-RK-300SP*
LPS-RK-1-1/4SP	LPS-RK-5-1/2SP	LPS-RK-45SP*	LPS-RK-350SP*
LPS-RK-1-1/3SP	LPS-RK-6SP*	LPS-RK-50SP*	LPS-RK-400SP*
LPS-RK-1-1/2SP	LPS-RK-6-1/2SP*	LPS-RK-60SP*	LPS-RK-450SP*
LPS-RK-1-1/4SP	LPS-RK-7SP*	LPS-RK-70SP*	LPS-RK-500SP*
LPS-RK-1-1/3SP	LPS-RK-8SP*	LPS-RK-80SP*	LPS-RK-600SP*
LPS-RK-2SP	LPS-RK-9SP*	LPS-RK-90SP*	

*Available with optional replace fuse indication. To order, place "I" at end of Catalog Number. Example: LPS-RK-15SP_I.

Low voltage
branch circuit
fuses

Data Sheets: LPN-RK — 1003 (0-60) and 1004 (70-600)
LPS-RK — 1001 (0-60) and 1002 (70-600)

Recommended fuse holders and blocks for Class RK1 fuses

- See page 1-3

Low voltage, branch circuit fuses

Low-Peak™ dual-element, time-delay fuses

Time-current characteristic curves—average melt

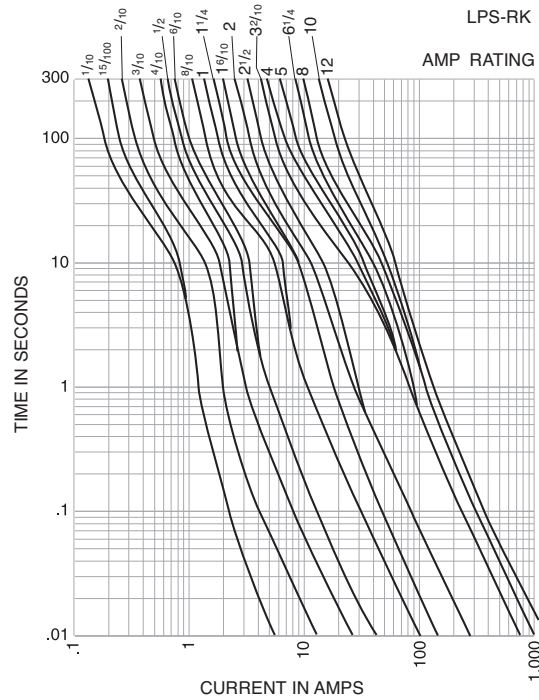
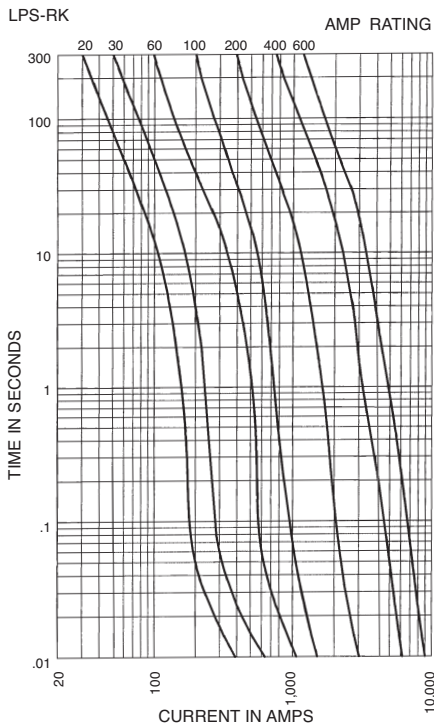
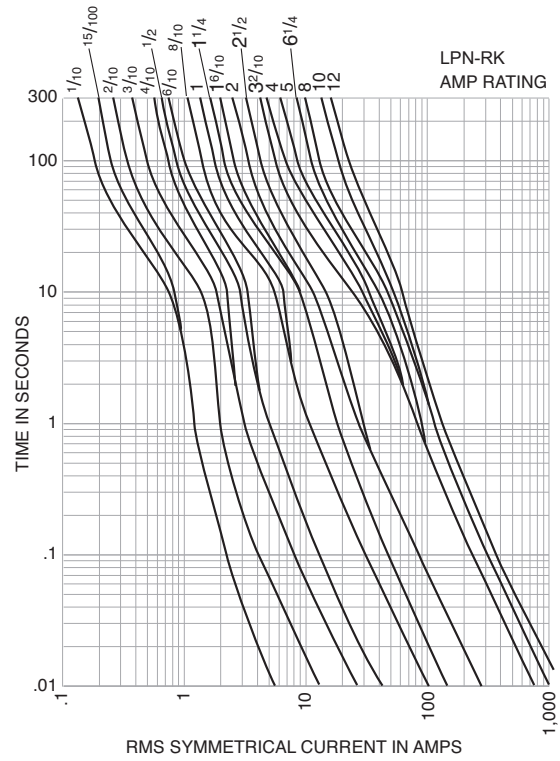
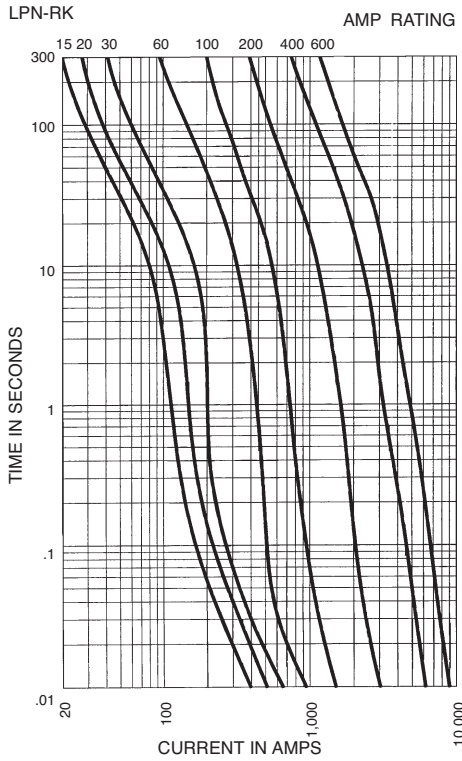

Data Sheets: LPN-RK — 1003 (0-60) and 1004 (70-600)
Data Sheets: LPS-RK — 1001 (0-60) and 1002 (70-600)

Recommended fuse holders and blocks for Class RK1 fuses
• See page 1-3

Current limitation curves—LPN-RK

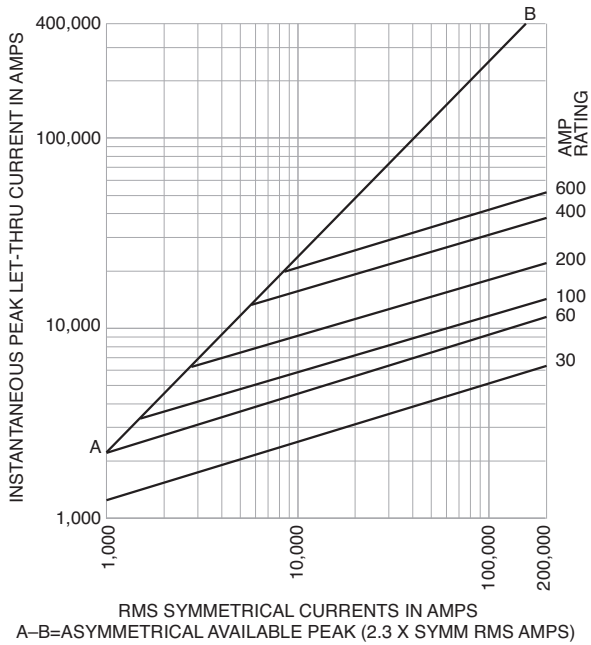

Current limitation curves—LPS-RK

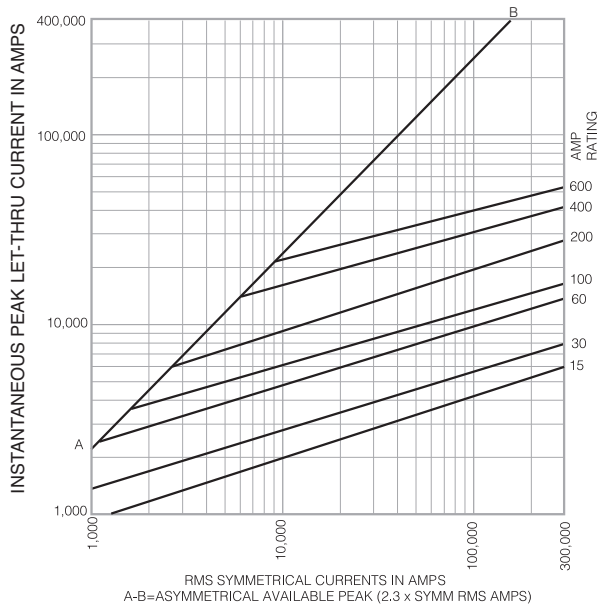

Data Sheets: LPN-RK — 1003 (0-60) and 1004 (70-600)
Data Sheets: LPS-RK — 1001 (0-60) and 1002 (70-600)

Recommended fuse holders and blocks for Class RK1 fuses
• See page 1-3

KTN-R (250V) Class RK1

Specifications:

Description: Fast-acting, current-limiting fuse.

Dimensions: See page 1-5 for Class RK1 dimensions.

Ratings:

- Volts — 250Vac (or less)
- 250Vac (70-350A)
- Amps — 1-600A
- IR — 200kA RMS Sym.
- 100kA Vdc



Agency information: CE, Std. 248-12, Class RK1, UL Listed, Guide JDDZ, File E4273, CSA Certified, Class 1422-02, File 53787.

Features and benefits:

- Current limitation for non-inductive circuits provides Class RK1 current-limiting response to maximum ground fault and short-circuit conditions.
- 200kA interrupting rating provides high ratings at all circuit locations.
- Economical solutions for high-fault circuits.

Typical applications:

- Panelboards

Catalog numbers (amps)

KTN-R-1	KTN-R-30	KTN-R-125
KTN-R-2	KTN-R-35	KTN-R-150
KTN-R-3	KTN-R-40	KTN-R-175
KTN-R-4	KTN-R-45	KTN-R-200
KTN-R-5	KTN-R-50	KTN-R-225
KTN-R-6	KTN-R-60	KTN-R-250
KTN-R-8	KTN-R-70	KTN-R-300
KTN-R-10	KTN-R-75	KTN-R-350
KTN-R-12	KTN-R-80	KTN-R-400
KTN-R-15	KTN-R-90	KTN-R-450
KTN-R-20	KTN-R-100	KTN-R-500
KTN-R-25	KTN-R-110	KTN-R-600

For superior electrical protection, Eaton recommends upgrading KTN-R fuse applications to Bussmann series Low-Peak LPN-RK fuses See page 1-25.

Recommended fuse holders and blocks for Class RK1 fuses

- See page 1-3

Time-current characteristic curves—average melt

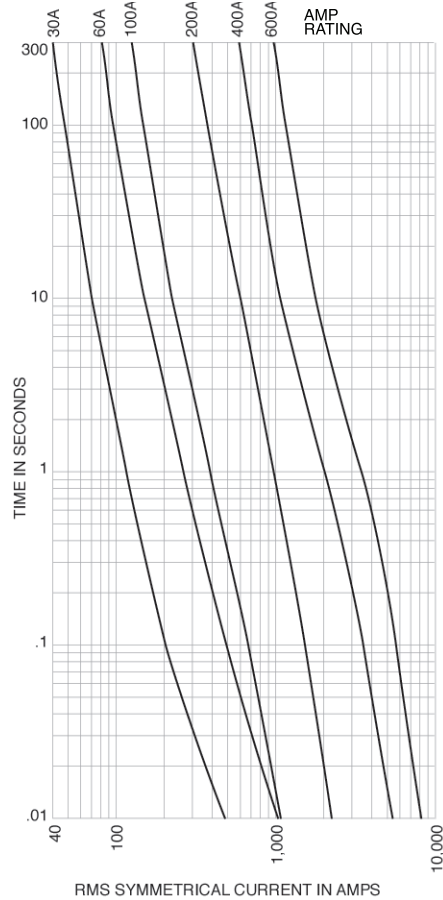

Current limitation curves

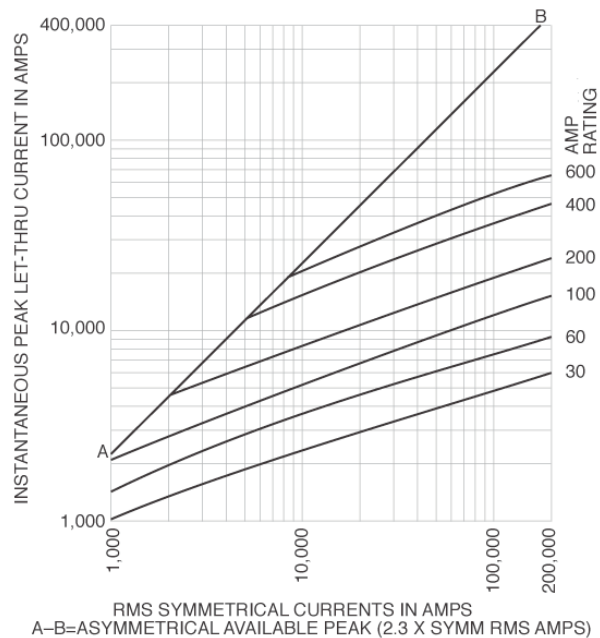

KTS-R (600V) Class RK1

Specifications:

Description: Fast-acting, current-limiting fuse.

Dimensions: See page 1-5 for Class RK1 dimensions.

Ratings:

- Volts — 600Vac (or less)
- Amps — 1-600A
- IR — 200kA RMS Sym.

Agency information: CE, Std. 248-12, Class RK1, UL Listed, Guide JDDZ, File E54273, CSA Certified, C22.2 No. 248.12, Class 1422-02, File 53787.

Features and benefits:

- Current limitation for non-inductive circuits provides Class RK1 current-limiting response to maximum ground fault and short-circuit conditions.
- 200kA interrupting rating provides high ratings at all circuit locations.
- Economical solutions for high-fault circuits.

Typical applications:

- Panelboards

Catalog numbers (amps)

KTS-R-1	KTS-R-30	KTS-R-125
KTS-R-2	KTS-R-35	KTS-R-150
KTS-R-3	KTS-R-40	KTS-R-175
KTS-R-4	KTS-R-45	KTS-R-200
KTS-R-5	KTS-R-50	KTS-R-225
KTS-R-6	KTS-R-60	KTS-R-250
KTS-R-8	KTS-R-70	KTS-R-300
KTS-R-10	KTS-R-75	KTS-R-350
KTS-R-12	KTS-R-80	KTS-R-400
KTS-R-15	KTS-R-90	KTS-R-450
KTS-R-20	KTS-R-100	KTS-R-500
KTS-R-25	KTS-R-110	KTS-R-600



Time-current characteristic curves—average melt

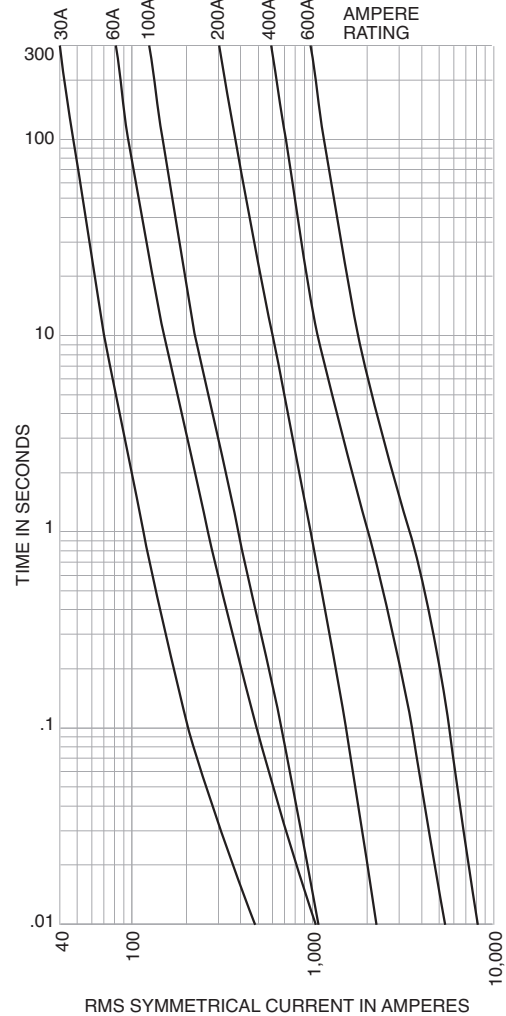

Current limitation curves

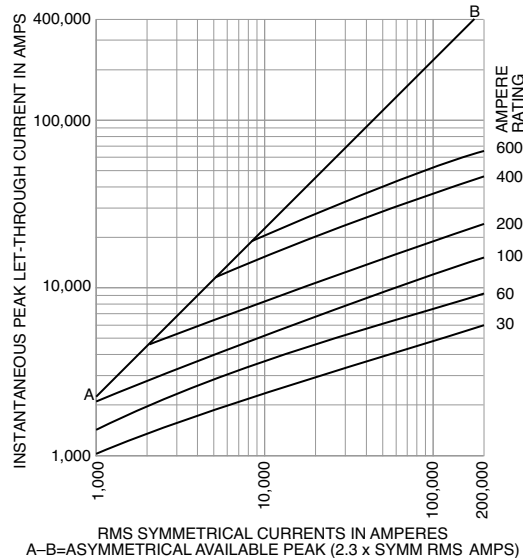

For superior electrical protection, Eaton recommends upgrading KTN-R fuse applications to Bussmann series Low-Peak LPN-RK fuses See page 1-25.

Recommended fuse holders and blocks for Class RK1 fuses

- See page 1-3

Low voltage branch circuit fuses

1

Low voltage, branch circuit fuses

Fusetron™ energy efficient, dual-element, time-delay fuses

FRN-R (250V) Class RK5

Specifications:

Description: Dual-element, time-delay fuse – 10 seconds (minimum) at 500% rated amps (8 seconds for 0-30A sizes). Available with indication on select ratings (see catalog numbers table).

Dimensions: See page 1-5 for Class RK5 dimensions.

Ratings:

- Volts — 250Vac (or less)
- 125Vdc (1/10-60A, 110-200A)
- 250Vdc (225-600A)
- Amps — 1/10-600A
- IR — 200kA RMS Sym.
- 20kA DC

Available with indication



Agency information: CE, Std. 248-12, Class RK5, UL Listed, Guide JDDZ, File E4273, CSA Certified, Class 1422-01, File 53787.

Features and benefits:

- Separate overload and short-circuit elements provide time delay for sizing as close as 125% of motor FLA.
- 2:1 selective coordination amp ratio (within the Fusetron RK5 fuse family) prevents overcurrent events from opening upstream Fusetron fuses.
- Insulated end caps for 225A-600A fuses reduces exposure to live parts and extends air gap to distance between blades of adjacent mounted fuses or to housing.

Typical applications:

- Power panelboards
- Motor control centers
- Combination starters
- Machinery disconnects

Catalog numbers (amps)

FRN-R-1/10	FRN-R-2	FRN-R-10*	FRN-R-100
FRN-R-1/8	FRN-R-2-1/4	FRN-R-12*	FRN-R-110
FRN-R-15/100	FRN-R-2-1/2	FRN-R-15*	FRN-R-125
FRN-R-3/8	FRN-R-2-3/8	FRN-R-17-1/2*	FRN-R-150
FRN-R-1/4	FRN-R-3	FRN-R-20*	FRN-R-175
FRN-R-3/16	FRN-R-3-3/16	FRN-R-25*	FRN-R-200
FRN-R-1/2	FRN-R-3-1/2	FRN-R-30*	FRN-R-225
FRN-R-3/16	FRN-R-4	FRN-R-35*	FRN-R-250
FRN-R-3/8	FRN-R-4-1/2	FRN-R-40*	FRN-R-300
FRN-R-1/2	FRN-R-5	FRN-R-45*	FRN-R-350
FRN-R-1	FRN-R-5-3/8	FRN-R-50*	FRN-R-400
FRN-R-1-1/8	FRN-R-6	FRN-R-60*	FRN-R-450
FRN-R-1-1/4	FRN-R-6-1/4	FRN-R-70	FRN-R-500
FRN-R-1-3/8	FRN-R-7	FRN-R-75	FRN-R-600
FRN-R-1-1/2	FRN-R-7-1/2	FRN-R-80	
FRN-R-1-5/8	FRN-R-8*	FRN-R-85	
FRN-R-1-3/4	FRN-R-9*	FRN-R-90	

*Available with indication. To order, place "ID" at the end of the catalog number. Example: FRN-R-30ID

Time-current characteristic curves—average melt

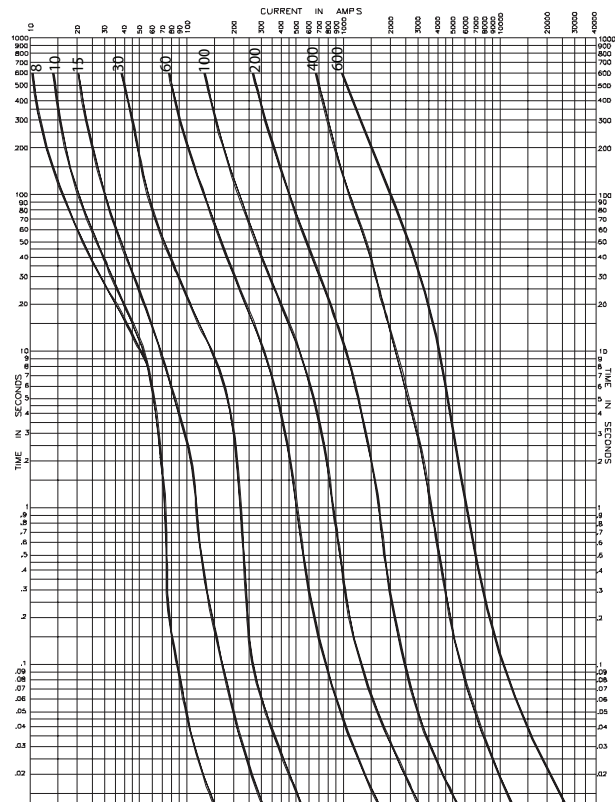

Current limitation curves

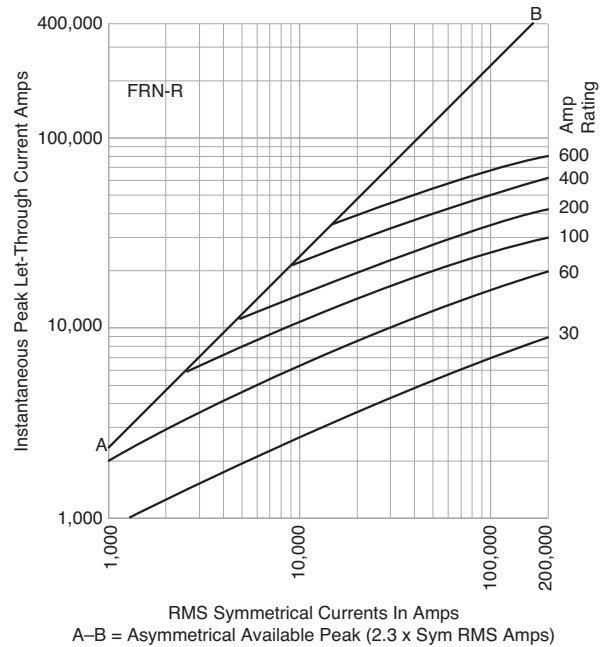

For superior electrical protection, Eaton recommends upgrading FRN-R fuse applications to Bussmann series Low-Peak LPN-RK fuses. See page 1-25.

Recommended fuse holders and blocks for Class RK5 fuses

- See page 1-3

Recommended fuse reducers for Class R fuses

- See page 1-4

Data Sheets: 1019 (1/10-60) and 1020 (70-600)

Low voltage, branch circuit fuses

Fusetron™ energy efficient, dual-element, time-delay fuses

FRS-R (600V) Class RK5

Specifications:

Description: Dual-element, time-delay fuse – 10 seconds (minimum) at 500% rated amps. Now available with optional indication on select ratings (see catalog numbers table).

Dimensions: See page 1-5 for Class RK5 dimensions.

Ratings:

- Volts — 600Vac (or less)
- 300Vdc 1/10-30A, 65-600
- 250Vdc 35-60A
- Amps — 1/10-600A
- IR — 200kA RMS Sym.
- 20kA DC



Available with indication



Agency information: CE, Std. 248-12, Class RK5, UL Listed, Guide JDDZ, File E4273, CSA Certified, Class 1422-02, File 53787.

Features and benefits:

- 2:1 selective coordination ratio (within RK5 fuse family) prevents electrical shutdowns from extending beyond the failed circuit.
- Insulated end caps for 65-600A fuses reduces exposure to live parts and extends air gap to distance between blades of adjacent mounted fuses or to housing.

Typical applications

- Power panelboards
- Motor control centers
- Combination starters
- Machinery disconnects

Catalog numbers (amps)

FRS-R-1/10	FRS-R-2	FRS-R-10*	FRS-R-100
FRS-R-1/8	FRS-R-2-1/4	FRS-R-12*	FRS-R-110
FRS-R-1/6	FRS-R-2-1/2	FRS-R-15*	FRS-R-125
FRS-R-1/4	FRS-R-2-3/4	FRS-R-17-1/2*	FRS-R-150
FRS-R-3/8	FRS-R-3	FRS-R-20*	FRS-R-175
FRS-R-1/2	FRS-R-3-1/4	FRS-R-25*	FRS-R-200
FRS-R-3/4	FRS-R-3-1/2	FRS-R-30*	FRS-R-225
FRS-R-1	FRS-R-3-3/4	FRS-R-35*	FRS-R-250
FRS-R-1-1/8	FRS-R-4	FRS-R-40*	FRS-R-300
FRS-R-1-1/4	FRS-R-4-1/2	FRS-R-45*	FRS-R-350
FRS-R-1-1/2	FRS-R-5	FRS-R-50*	FRS-R-400
FRS-R-1-3/4	FRS-R-5-1/4	FRS-R-60*	FRS-R-450
FRS-R-2	FRS-R-6*	FRS-R-65	FRS-R-500
FRS-R-2-1/4	FRS-R-6-1/4*	FRS-R-70	FRS-R-600
FRS-R-2-1/2	FRS-R-7*	FRS-R-75	
FRS-R-2-3/4	FRS-R-7-1/2*	FRS-R-80	
FRS-R-3	FRS-R-8*	FRS-R-90	
FRS-R-3-1/4	FRS-R-9*		

*Available with indication. To order, place "ID" at the end of the catalog number. Example: FRS-R-7ID.

Time-current characteristic curves—average melt

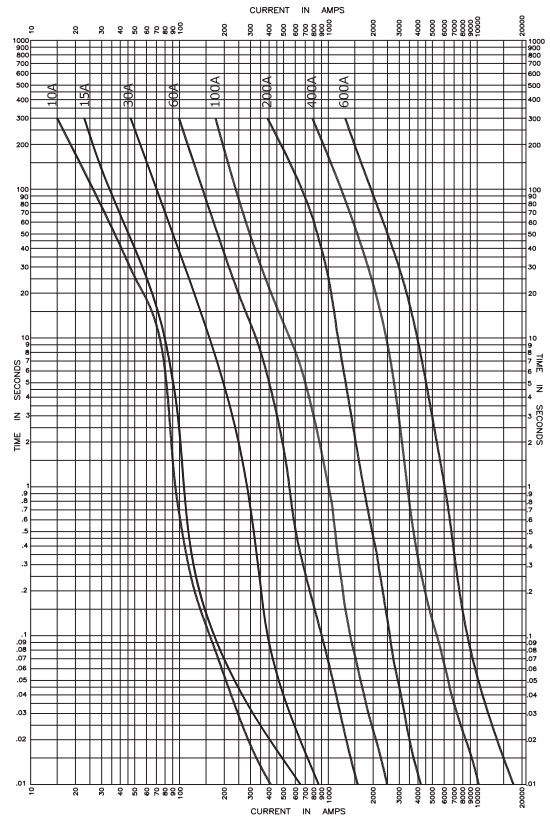

Current limitation curves

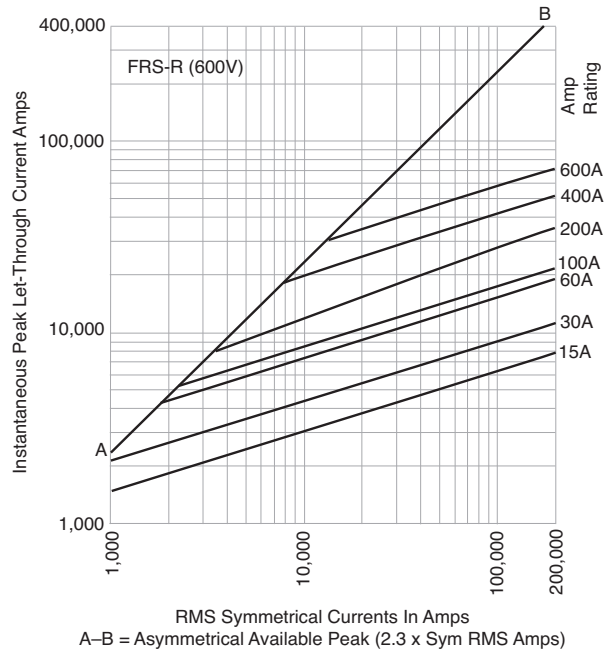

For superior electrical protection, Eaton recommends upgrading FRS-R fuse applications to Bussmann series Low-Peak LPS-RK fuses. See page 1-25.

Data Sheet: 1017 (1/10-60), 1018 (65-600)

- Recommended fuse holders and blocks for Class RK5 fuses • See page 1-3
- Recommended fuse reducers for Class R fuses • See page 1-4

Low voltage branch circuit fuses

JJN 300V, Class T

Specifications:

Description: Very fast-acting, current-limiting fuse.

Dimensions: See page 1-6 for Class T dimensions.

Ratings:

- Volts — 300Vac (or less)
- 160Vdc (15-600A)
- 170Vdc (601-1200A)

Amps — 1-1200A

- IR — 200kA RMS Sym.
- 20kA DC @ 160Vdc
- 100kA DC @ 170Vdc

Agency information: CE, Std. 248-15, Class T, UL Listed, Guide JDDZ, File E4273, CSA Certified, Class 1422-02, File 53787, RoHS compliant.

Features and benefits:

- Series combination ratings with branch circuit breakers allows broad range of coverage, independent of breaker manufacturer.
- Current limitation for non-inductive circuits provides Class T current-limiting response to maximum ground fault and short-circuit conditions.
- 200kA interrupting rating provides high ratings at all circuit locations.
- Small footprint allows more efficient use of available space.

Typical applications:

- Large apartment complexes
- Multi-family meter stacks
- VFD line protection

Catalog numbers (amps)

JJN-1	JJN-15	JJN-40	JJN-80	JJN-150	JJN-300	JJN-600
JJN-2	JJN-20	JJN-45	JJN-90	JJN-175	JJN-350	JJN-700
JJN-3	JJN-25	JJN-50	JJN-100	JJN-200	JJN-400	JJN-800
JJN-6	JJN-30	JJN-60	JJN-110	JJN-225	JJN-450	JJN-1000
JJN-10	JJN-35	JJN-70	JJN-125	JJN-250	JJN-500	JJN-1200



Time-current characteristic curves—average melt

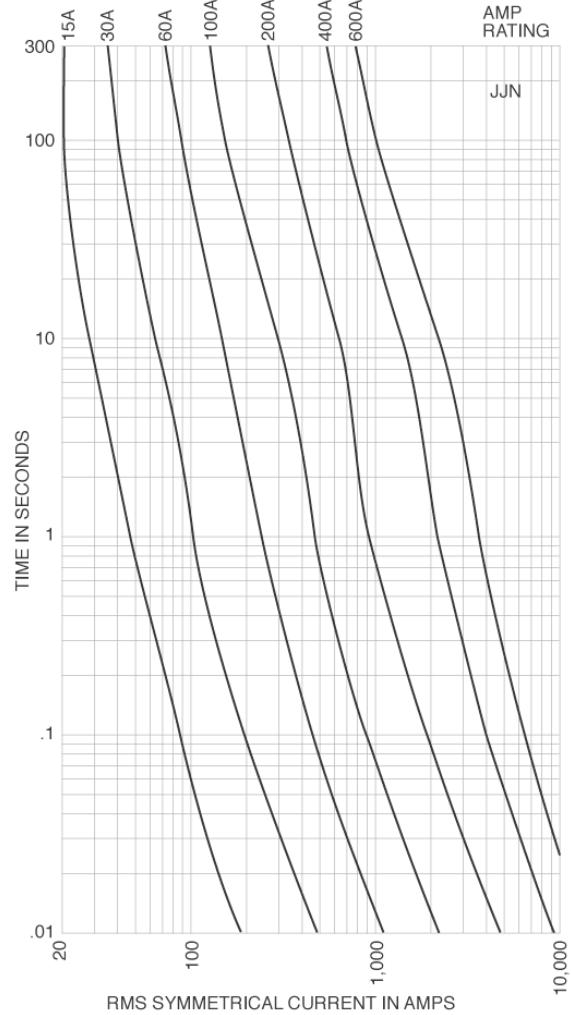

Current limitation curves

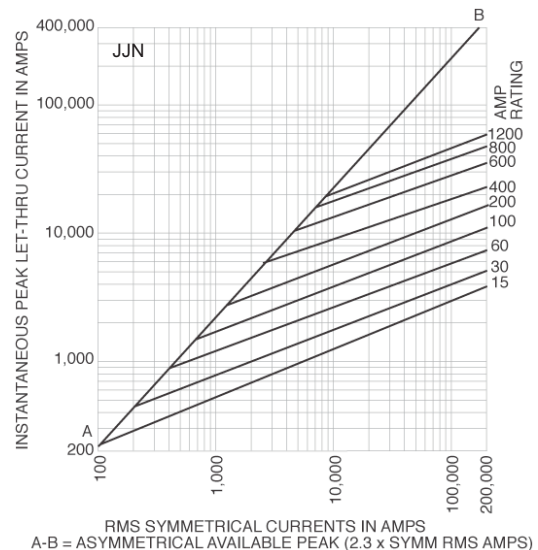

Recommended fuse holders and blocks for Class T fuses

- See page 1-3

Data Sheet: 1025

JJS 600V, Class T

Specifications:

Description: Very fast-acting, current-limiting fuse.

Dimensions: See page 1-6 for Class T dimensions.

Ratings:

Volts — 600Vac (or less)

Amps — 1-800A

IR — 200kA RMS Sym.

Agency information: CE, Std. 248-15, Class T, UL Listed, Guide JDDZ, File E4273, CSA Certified, Class 1422-02, File 53787, RoHS compliant.

Features and benefits:

- Series combination ratings with branch circuit breakers allows broad range of coverage, independent of breaker manufacturer.
- Current limitation for non-inductive circuits provides Class T current-limiting response to maximum ground fault and short-circuit conditions.
- 200kA interrupting rating provides high ratings at all circuit locations.
- Small footprint allows more efficient use of available space.

Typical applications:

- Large apartment complexes
- Multi-family meter stacks
- VFD line protection

Catalog numbers (amps)

JJS-1	JJS-15	JJS-40	JJS-80	JJS-150	JJS-300	JJS-600
JJS-2	JJS-20	JJS-45	JJS-90	JJS-175	JJS-350	JJS-800
JJS-3	JJS-25	JJS-50	JJS-100	JJS-200	JJS-400	
JJS-6	JJS-30	JJS-60	JJS-110	JJS-225	JJS-450	
JJS-10	JJS-35	JJS-70	JJS-125	JJS-250	JJS-500	



Time-current characteristic curves—average melt

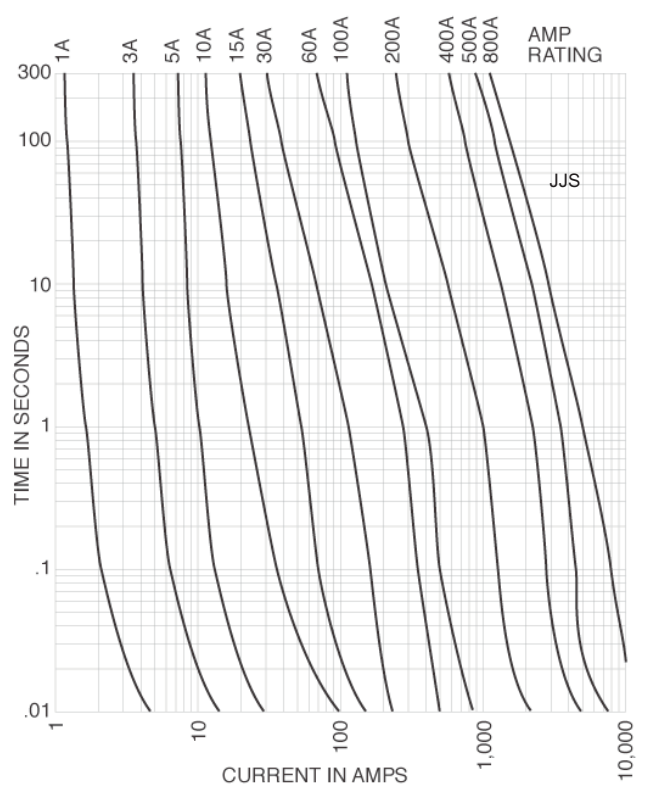

Low voltage branch circuit fuses

Current limitation curves

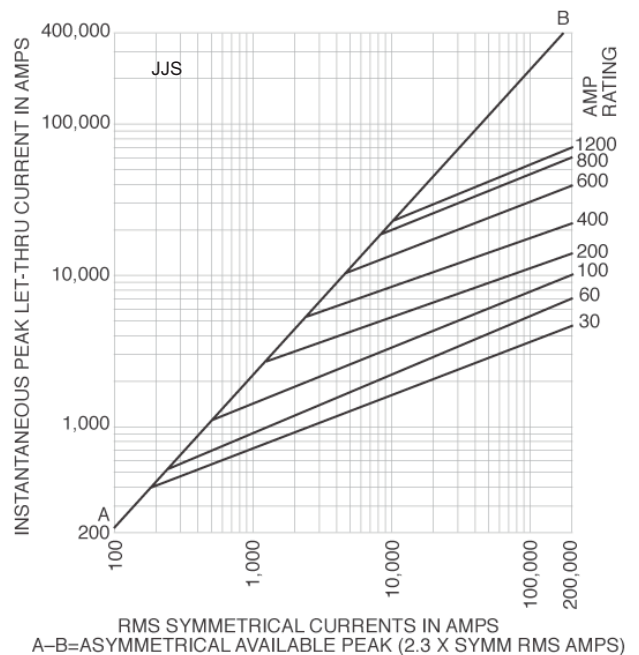

Recommended fuse holders and blocks for Class T fuses

- See page 1-3

Data Sheet: 1029

1

Low voltage, branch circuit fuses

Plug fuses

W

Specifications:

Description: Fast-acting plug fuse.

Dimensions: Edison base plug.

Construction: Brass threads with plastic body.

Ratings:

Volts — 125Vac

Amps — ½-12A

IR — 10kA RMS Sym.

Agency information: CE, Std. 248-11, UL Listed, Guide JEFV, File E12112.

Features and benefits:

- Dependable, fast-acting circuit protection with 10kA interrupting rating for added safety when applied to existing plug fuse systems and 125-volt single-phase control circuits.

Typical applications:

- Replacement only in existing systems.
- For general purpose circuit protection.
- Use for lighting and other non-motor circuits.

Catalog numbers* (amps)

W-½	W-2 ½	W-6	W-10
W-1	W-3	W-6 ½	W-12
W-1 ¼	W-4	W-7	W-DUMMY**
W-2	W-5	W-8	

*W-15, W-20, W-25, and W-30 plug fuses obsoleted. Suggest replacing with either T-(Amp) or TL-(Amp) plug fuses.

** Non-conductive dummy base. Not a fuse.



SL and TL

Specifications

Description: Time-delay, loaded link plug fuse.

Dimensions:

SL — Rejection base

TL — Edison base

Construction:

SL — Plastic base with rejection threads

TL — Brass threads with plastic body

Ratings:

Volts — 125Vac

Amps — 15-30A

IR — 10kA RMS Sym.

Agency information: CE, Std. 248-11, UL Listed, Guide JEFV, File E12112.

Features and benefits

- Time-delay loaded link TL Edison base plug fuses pass motor overload starting currents without opening and allow closer sizing to motor load for added protection.
- Time-delay loaded link SL fuses provide a rejection feature (when used alone or with Fustat adapters to retrofit Edison base holders) to help prevent overfusing.

Typical applications

- Small motor and inductive load circuits with high in-rush current levels.
- Used with box cover units to provide equipment protection.
- Applications benefiting from fuse rejection (SL series only).

SL catalog numbers (amps)

SL-15	SL-20	SL-25	SL-30
-------	-------	-------	-------

TL catalog numbers (amps)

TL-15	TL-20	TL-25	TL-30
-------	-------	-------	-------



Recommended fuse holders for W plug fuses

- See page 1-4

Data Sheet: 1036

Recommended fuse holders for SL and TL plug fuses

- See page 1-4
- See page 1-36 for Fustat adapters for use with SL plug fuses

Data Sheets: 1033 (SL) and 1035 (TL)

S and T

Specifications:

Description: Dual-element, time-delay plug fuse.

Dimensions:

- S — Rejection base
- T — Edison base

Construction:

- S — Plastic base with rejection threads
- T — Brass threads with plastic body

Ratings:

- Volts — 125Vac
- Amps — S: ¼-30A
- T: ¼-30A
- IR — 10kA RMS Sym.

Agency information: CE, Std. 248-11, Type S and T; UL Listed (0-6½) Guide JFHR, File E56412 (7-30A) Guide JEFV, File E12112; CSA Certified, Class 1423-01, File 53787.

Features and benefits:

- Time-delay, dual-element T Edison base plug fuses provide small motor overload protection when used with box cover units.
- Time-delay, dual-element S plug fuses provide a rejection feature (when used alone or with Fustat adapters to retrofit Edison base holders) to prevent overfusing of branch circuits.

Typical applications:

- S — residential load centers
- T — box cover units for small motor overload protection
- Applications benefiting from fuse rejection (S only)

S catalog numbers (amps)

S-¼	S-⅜	S-1-⅛	S-2-¼	S-4-½	S-7	S-14
S-⅜	S-1	S-1-⅜	S-3	S-5	S-8	S-15
S-⅜	S-1-¼	S-2	S-3-⅜	S-5-⅜	S-9	S-20
S-½	S-1-¼	S-2-¼	S-3-½	S-6	S-10	S-25
S-⅝	S-1-⅝	S-2-½	S-4	S-6-¼	S-12	S-30

T catalog numbers (amps)

T-⅜	T-1-⅜	T-2-¼	T-4	T-7	T-15
T-⅜	T-1-¼	T-2-½	T-4-½	T-8	T-20
T-½	T-1-⅝	T-2-⅝	T-5	T-9	T-25
T-⅝	T-1-⅝	T-3	T-5-⅝	T-10	T-30
T-⅝	T-1-⅝	T-3-⅝	T-6	T-12	
T-1	T-2	T-3-½	T-6-¼	T-14	

Data Sheet: 1032 (S) and 1034 (T)

Recommended fuse holders for S and T plug fuses

- See page 1-4
- See page 1-36 for Fustat adapters for use with S plug fuse



P and TC

Specifications:

Description:

- P - Type P dual-element fuse
- TC - Type D dual-element, time-delay fuse

Dimensions:

 Edison base

Construction: Brass threads with plastic body.

Ratings:

- Volts — 125Vac or less
- Amps — 15-30A
- IR — 10kA

Agency information:

- P - CSA Certified
- TC - CSA Certified (Class 1423-01, File # 53787)

Features and benefits:

- P
 - “P” rating for Canadian applications.
 - Non-time delay for non-inductive loads
- TC
 - “D” rating for Canadian applications
 - Heavy duty TC fuses are industrial strength products, featuring dual-element construction.
 - This spring loaded design provides superior short-circuit and overload protection.
 - The TC fuses have more time-delay than the medium duty fuses in order to better protect industrial motors and residential circuits.

Typical applications:

- P — Non-inductive loads, residential load centers
- TC — Box cover units for small motor overload protection

P catalog numbers (amps)

P-15	P-20	P-25	P-30
------	------	------	------

TC catalog numbers (amps)

TC-15	TC-20	TC-25	TC-30
-------	-------	-------	-------



Low voltage branch circuit fuses

Data Sheet: 1039 (TC only)

Recommended fuse holders for P and TC plug fuses

- See page 1-4
- See page 1-36 for Fustat adapters for use with S plug fuse

1

Low voltage, branch circuit fuses

Plug fuses

MB Edison base circuit breakers

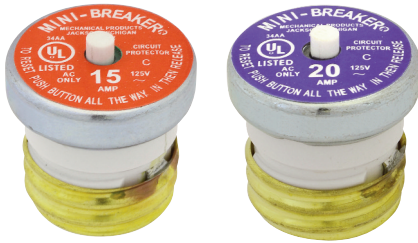

Specifications:

Description: Edison base manual reset circuit breakers.

Dimensions: Edison base

Construction: Brass threads with plastic body

Ratings:

Volts — 125Vac only

Amps — 15-20A

IR — 10kA RMS Sym.

Agency information: UL Listed, File E14942

Features and benefits:

- Fit standard Edison base fuse receptacles.
- Resettable upon overload event.

Typical applications:*

- Replacing Edison base plug fuses in residential fuse panels.

Catalog numbers* (Amps)

MB-15
MB-20

* Not for use in box cover units or for inductive loads.

SA Fustat fuse adapters



Specifications:

Description: Adapters for using Type S and SL rejection fuses in Edison base fuse sockets.

Agency information: UL Listed, File E12853; CSA Certified File #6225-01, File #47235.

Features and benefits:

- Fustat adapters screw into the “Edison” thread fuse sockets of standard fuse boxes making it easy to retrofit existing fuse installations
- Available in various amp ratings to cover a wide range of rating requirements

Typical applications:

- Plug fuse installations where it is desirable to restrict fuse amp ratings

Catalog numbers (amps)

SA-1*	SA-3- ¹ / ₀ * [*]	SA-10*
SA-1- ¹ / ₄ * [*]	SA-4*	SA-15**
SA-1- ⁵ / ₀ * [*]	SA-5*	SA-20**
SA-2*	SA-6- ¹ / ₄ * [*]	SA-30**
SA-2- ¹ / ₂ * [*]	SA-8*	

* Single motor circuits.

** Branch circuits.

Fustat™ adapters for small motor protection*

Adapter	Accepts fuses
SA-1	S-1 or smaller
SA-1- ¹ / ₄	S-1- ¹ / ₄ or smaller
SA-1- ⁵ / ₀	S-1- ⁵ / ₀ or smaller
SA-2	S-2 or S-1- ⁵ / ₀
SA-2- ¹ / ₂	S-2- ¹ / ₂ to S-1- ⁵ / ₀
SA-3- ³ / ₀	S-3- ³ / ₀ to S-1- ⁵ / ₀
SA-4	S-4 to S-3- ¹ / ₂
SA-5	S-5 to S-3- ¹ / ₂
SA-6- ¹ / ₄	S-6- ¹ / ₄ to S-3- ¹ / ₂
SA-8	S-8 to S-7
SA-10	S-10 to S-7
SA-15	S-15 to S-7
SA-20	S-20
SA-30	S-30 to S-25

* Both motor running and short-circuit protection.

Fustat™ adapters for branch circuit protection

Adapter	Accepts fuses
SA-15	S-15 to S-7
SA-20	S-20
SA 30	S-30 to S-25