



Is Now Part of



ON Semiconductor®

To learn more about ON Semiconductor, please visit our website at
www.onsemi.com

Please note: As part of the Fairchild Semiconductor integration, some of the Fairchild orderable part numbers will need to change in order to meet ON Semiconductor's system requirements. Since the ON Semiconductor product management systems do not have the ability to manage part nomenclature that utilizes an underscore (_), the underscore (_) in the Fairchild part numbers will be changed to a dash (-). This document may contain device numbers with an underscore (_). Please check the ON Semiconductor website to verify the updated device numbers. The most current and up-to-date ordering information can be found at www.onsemi.com. Please email any questions regarding the system integration to Fairchild_questions@onsemi.com.

ON Semiconductor and the ON Semiconductor logo are trademarks of Semiconductor Components Industries, LLC dba ON Semiconductor or its subsidiaries in the United States and/or other countries. ON Semiconductor owns the rights to a number of patents, trademarks, copyrights, trade secrets, and other intellectual property. A listing of ON Semiconductor's product/patent coverage may be accessed at www.onsemi.com/site/pdf/Patent-Marking.pdf. ON Semiconductor reserves the right to make changes without further notice to any products herein. ON Semiconductor makes no warranty, representation or guarantee regarding the suitability of its products for any particular purpose, nor does ON Semiconductor assume any liability arising out of the application or use of any product or circuit, and specifically disclaims any and all liability, including without limitation special, consequential or incidental damages. Buyer is responsible for its products and applications using ON Semiconductor products, including compliance with all laws, regulations and safety requirements or standards, regardless of any support or applications information provided by ON Semiconductor. "Typical" parameters which may be provided in ON Semiconductor data sheets and/or specifications can and do vary in different applications and actual performance may vary over time. All operating parameters, including "Typicals" must be validated for each customer application by customer's technical experts. ON Semiconductor does not convey any license under its patent rights nor the rights of others. ON Semiconductor products are not designed, intended, or authorized for use as a critical component in life support systems or any FDA Class 3 medical devices or medical devices with a same or similar classification in a foreign jurisdiction or any devices intended for implantation in the human body. Should Buyer purchase or use ON Semiconductor products for any such unintended or unauthorized application, Buyer shall indemnify and hold ON Semiconductor and its officers, employees, subsidiaries, affiliates, and distributors harmless against all claims, costs, damages, and expenses, and reasonable attorney fees arising out of, directly or indirectly, any claim of personal injury or death associated with such unintended or unauthorized use, even if such claim alleges that ON Semiconductor was negligent regarding the design or manufacture of the part. ON Semiconductor is an Equal Opportunity/Affirmative Action Employer. This literature is subject to all applicable copyright laws and is not for resale in any manner.

FDME1024NZT

Dual N-Channel PowerTrench® MOSFET

20 V, 3.8 A, 66 mΩ

Features

- Max $r_{DS(on)}$ = 66 mΩ at $V_{GS} = 4.5$ V, $I_D = 3.4$ A
- Max $r_{DS(on)}$ = 86 mΩ at $V_{GS} = 2.5$ V, $I_D = 2.9$ A
- Max $r_{DS(on)}$ = 113 mΩ at $V_{GS} = 1.8$ V, $I_D = 2.5$ A
- Max $r_{DS(on)}$ = 160 mΩ at $V_{GS} = 1.5$ V, $I_D = 2.1$ A
- Low profile: 0.55 mm maximum in the new package MicroFET 1.6x1.6 **Thin**
- Free from halogenated compounds and antimony oxides
- HBM ESD protection level > 1600 V (Note 3)
- RoHS Compliant



General Description

This device is designed specifically as a single package solution for dual switching requirement in cellular handset and other ultra-portable applications. It features two independent N-Channel MOSFETs with low on-state resistance for minimum conduction losses.

The MicroFET 1.6x1.6 **Thin** package offers exceptional thermal performance for its physical size and is well suited to switching and linear mode applications.

Applications

- Baseband Switch
- Load Switch

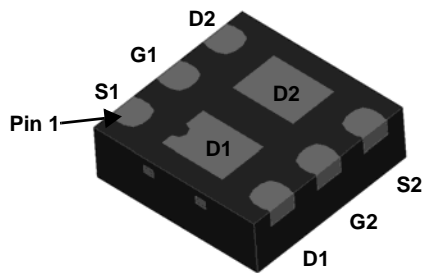

BOTTOM



TOP

MicroFET 1.6x1.6 Thin

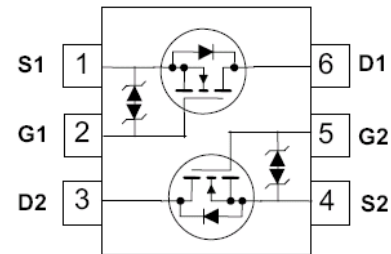

MOSFET Maximum Ratings $T_A = 25^\circ\text{C}$ unless otherwise noted

Symbol	Parameter	Rated	Units
V_{DS}	Drain to Source Voltage	20	V
V_{GS}	Gate to Source Voltage	± 8	V
I_D	Drain Current -Continuous $T_A = 25^\circ\text{C}$ (Note 1a)	3.8	A
	-Pulsed	6	
P_D	Power Dissipation for Single Operation $T_A = 25^\circ\text{C}$ (Note 1a)	1.4	W
	Power Dissipation for Single Operation $T_A = 25^\circ\text{C}$ (Note 1b)	0.6	
T_J, T_{STG}	Operating and Storage Junction Temperature Range	-55 to +150	$^\circ\text{C}$

Thermal Characteristics

$R_{\theta JA}$	Thermal Resistance, Junction to Ambient (Single Operation)	(Note 1a)	90	$^\circ\text{C/W}$
$R_{\theta JA}$	Thermal Resistance, Junction to Ambient (Single Operation)	(Note 1b)	195	

Package Marking and Ordering Information

Device Marking	Device	Package	Reel Size	Tape Width	Quantity
4T	FDME1024NZT	MicroFET 1.6x1.6 Thin	7"	8 mm	5000 units

Electrical Characteristics $T_J = 25\text{ }^\circ\text{C}$ unless otherwise noted

Symbol	Parameter	Test Conditions	Min	Typ	Max	Units
--------	-----------	-----------------	-----	-----	-----	-------

Off Characteristics

BV_{DSS}	Drain to Source Breakdown Voltage	$I_D = 250\text{ }\mu\text{A}$, $V_{GS} = 0\text{ V}$	20			V
$\frac{\Delta BV_{DSS}}{\Delta T_J}$	Breakdown Voltage Temperature Coefficient	$I_D = 250\text{ }\mu\text{A}$, referenced to $25\text{ }^\circ\text{C}$		16		mV/ $^\circ\text{C}$
I_{DSS}	Zero Gate Voltage Drain Current	$V_{DS} = 16\text{ V}$, $V_{GS} = 0\text{ V}$			1	μA
I_{GSS}	Gate to Source Leakage Current	$V_{GS} = \pm 8\text{ V}$, $V_{DS} = 0\text{ V}$			± 10	μA

On Characteristics

$V_{GS(th)}$	Gate to Source Threshold Voltage	$V_{GS} = V_{DS}$, $I_D = 250\text{ }\mu\text{A}$	0.4	0.7	1.0	V
$\frac{\Delta V_{GS(th)}}{\Delta T_J}$	Gate to Source Threshold Voltage Temperature Coefficient	$I_D = 250\text{ }\mu\text{A}$, referenced to $25\text{ }^\circ\text{C}$		-3		mV/ $^\circ\text{C}$
$r_{DS(on)}$	Static Drain to Source On Resistance	$V_{GS} = 4.5\text{ V}$, $I_D = 3.4\text{ A}$		55	66	m Ω
		$V_{GS} = 2.5\text{ V}$, $I_D = 2.9\text{ A}$		68	86	
		$V_{GS} = 1.8\text{ V}$, $I_D = 2.5\text{ A}$		85	113	
		$V_{GS} = 1.5\text{ V}$, $I_D = 2.1\text{ A}$		106	160	
		$V_{GS} = 4.5\text{ V}$, $I_D = 3.4\text{ A}$, $T_J = 125\text{ }^\circ\text{C}$		76	112	
g_{FS}	Forward Transconductance	$V_{DD} = 4.5\text{ V}$, $I_D = 3.4\text{ A}$		9		S

Dynamic Characteristics

C_{iss}	Input Capacitance	$V_{DS} = 10\text{ V}$, $V_{GS} = 0\text{ V}$, $f = 1\text{ MHz}$		225	300	pF
C_{oss}	Output Capacitance			40	55	pF
C_{rss}	Reverse Transfer Capacitance			25	40	pF

Switching Characteristics

$t_{d(on)}$	Turn-On Delay Time	$V_{DD} = 10\text{ V}$, $I_D = 1\text{ A}$, $V_{GS} = 4.5\text{ V}$, $R_{GEN} = 6\text{ }\Omega$		4.5	10	ns
t_r	Rise Time			2	10	ns
$t_{d(off)}$	Turn-Off Delay Time			15	27	ns
t_f	Fall Time			1.7	10	ns
Q_g	Total Gate Charge			3	4.2	nC
Q_{gs}	Gate to Source Gate Charge	$V_{DD} = 10\text{ V}$, $I_D = 3.4\text{ A}$, $V_{GS} = 4.5\text{ V}$		0.4		nC
Q_{gd}	Gate to Drain "Miller" Charge			0.6		nC

Drain-Source Diode Characteristics

V_{SD}	Source to Drain Diode Forward Voltage	$V_{GS} = 0\text{ V}$, $I_S = 0.9\text{ A}$ (Note 2)		0.7	1.2	V
t_{rr}	Reverse Recovery Time	$I_F = 3.4\text{ A}$, $di/dt = 100\text{ A}/\mu\text{s}$		8.5	17	ns
Q_{rr}	Reverse Recovery Charge			1.4	10	nC

NOTES:

1. $R_{\theta JA}$ is determined with the device mounted on a 1 in² pad 2 oz copper pad on a 1.5 x 1.5 in. board of FR-4 material. $R_{\theta JC}$ is guaranteed by design while $R_{\theta CA}$ is determined by the user's board design.



a. 90 $^\circ\text{C}/\text{W}$ when mounted on a 1 in² pad of 2 oz copper.

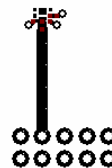

b. 195 $^\circ\text{C}/\text{W}$ when mounted on a minimum pad of 2 oz copper.

2. Pulse Test: Pulse Width < 300 μs , Duty cycle < 2.0%.

3. The diode connected between the gate and source serves only as protection ESD. No gate overvoltage rating is implied.

Typical Characteristics $T_J = 25\text{ }^\circ\text{C}$ unless otherwise noted

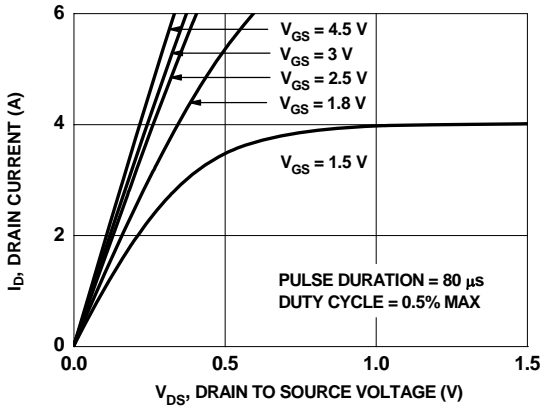

Figure 1. On-Region Characteristics

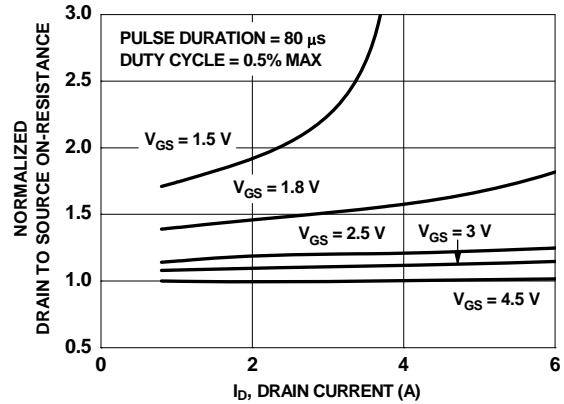

Figure 2. Normalized On-Resistance vs Drain Current and Gate Voltage

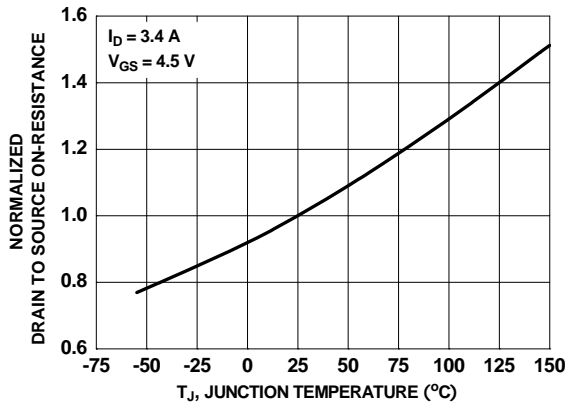

Figure 3. Normalized On-Resistance vs Junction Temperature

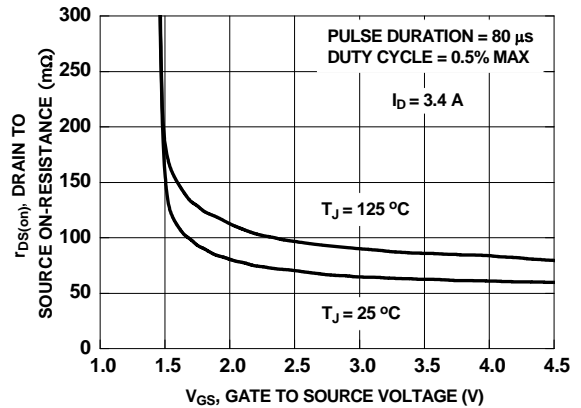

Figure 4. On-Resistance vs Gate to Source Voltage

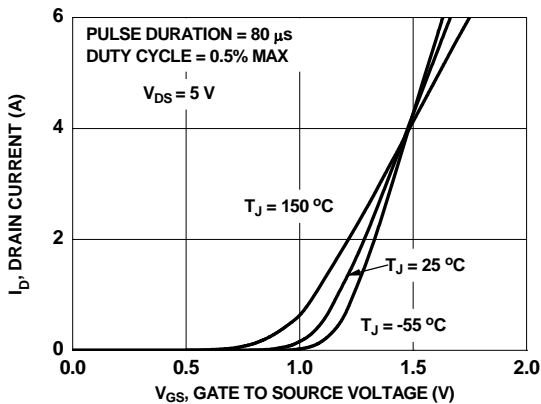

Figure 5. Transfer Characteristics

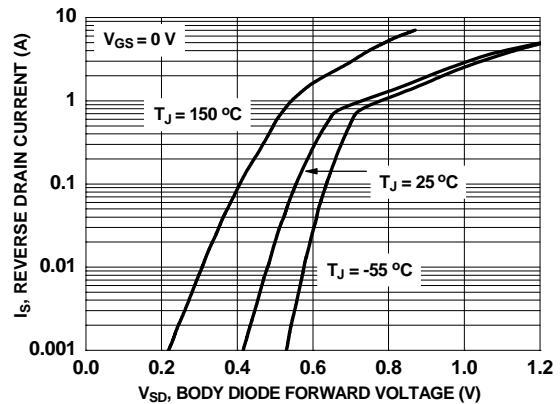

Figure 6. Source to Drain Diode Forward Voltage vs Source Current

Typical Characteristics $T_J = 25\text{ }^\circ\text{C}$ unless otherwise noted

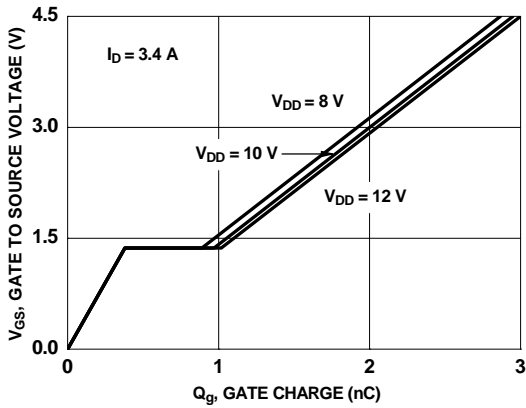

Figure 7. Gate Charge Characteristics

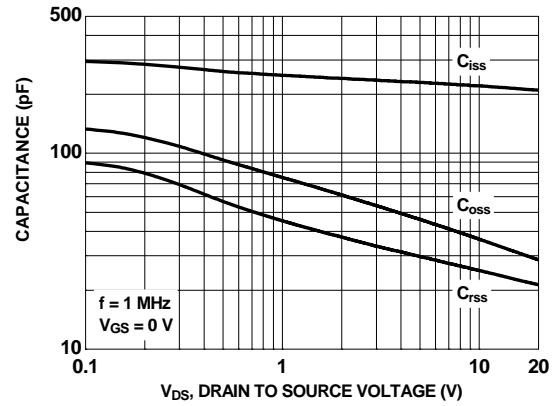

Figure 8. Capacitance vs Drain to Source Voltage

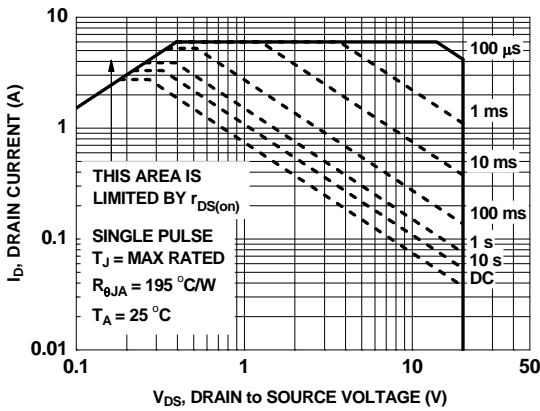

Figure 9. Forward Bias Safe Operating Area

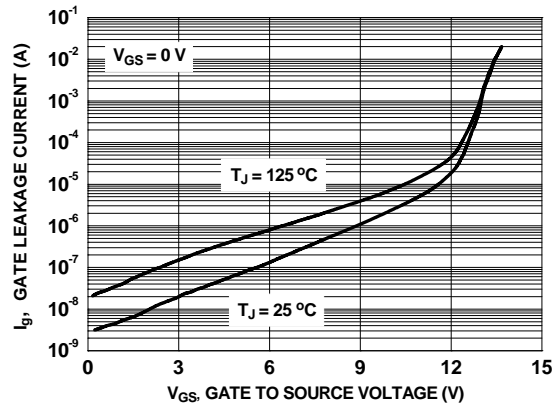

Figure 10. Gate Leakage Current vs Gate to Source Voltage

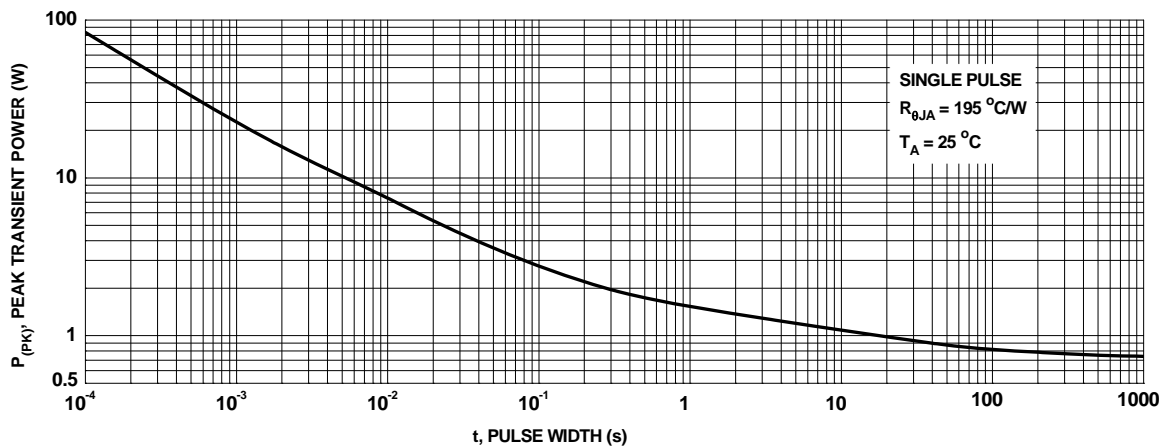

Figure 11. Single Pulse Maximum Power Dissipation

Typical Characteristics $T_J = 25\text{ }^\circ\text{C}$ unless otherwise noted

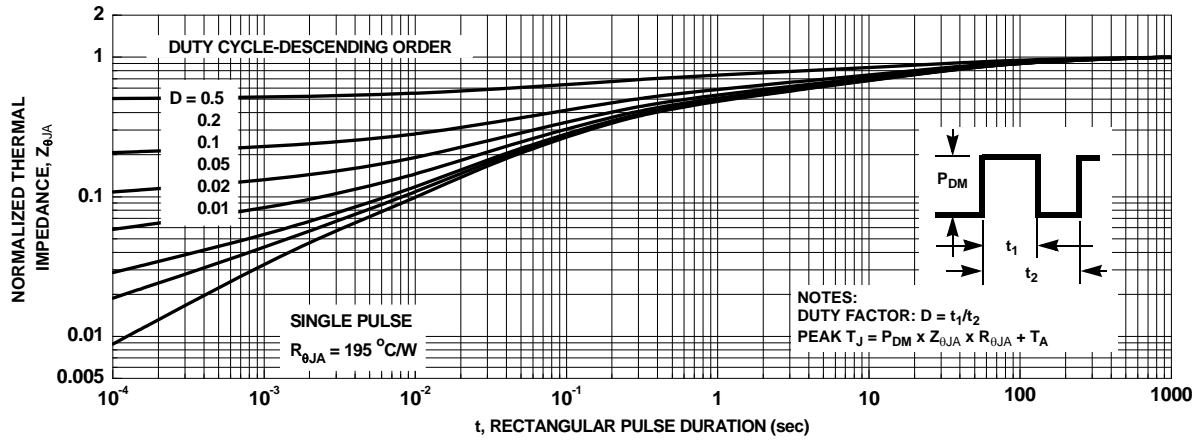
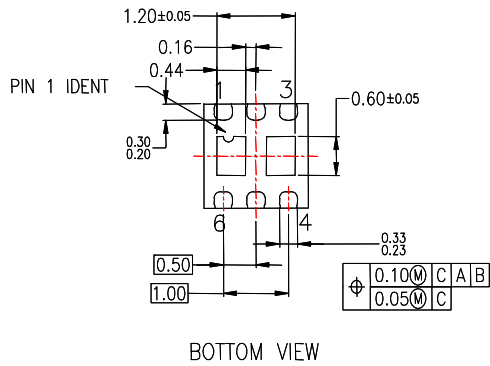
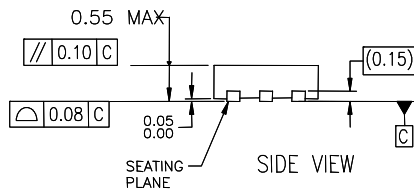
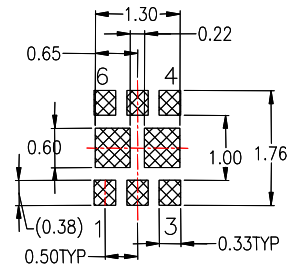
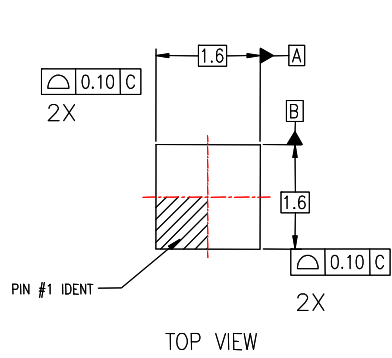

Figure 12. Junction-to-Ambient Transient Thermal Response Curve

Dimensional Outline and Pad Layout





TRADEMARKS

The following includes registered and unregistered trademarks and service marks, owned by Fairchild Semiconductor and/or its global subsidiaries, and is not intended to be an exhaustive list of all such trademarks.

- | | | | |
|--------------------------|-------------------------------------|---------------------------------------|--|
| AccuPower™ | F-PFS™ | Power-SPM™ | SYSTEM GENERAL ^{3D}
The Power Franchise® |
| Auto-SPM™ | FRFET® | PowerTrench® | |
| Build it Now™ | Global Power Resource SM | PowerXS™ | the power®
franchise |
| CorePLUS™ | Green FPS™ | Programmable Active Droop™ | |
| CorePOWER™ | Green FPS™ e-Series™ | QFET® | TinyBoost™ |
| CROSSVOLT™ | Gmax™ | QST™ | TinyBuck™ |
| CTL™ | GTO™ | Quiet Series™ | TinyCalc™ |
| Current Transfer Logic™ | IntelliMAX™ | RapidConfigure™ | TinyLogic® |
| DEUXPEED® | ISOPLANAR™ | Saving our world, 1mW/W/kW at a time™ | TINYOPTO™ |
| Dual Cool™ | MegaBuck™ | | SignalWise™ |
| EcoSPARK® | MICROCOUPLER™ | SmartMax™ | TinyPWM™ |
| EfficientMax™ | MicroFET™ | SMART START™ | TinyWire™ |
| ESBC™ | MicroPak™ | SPM® | TriFault Detect™ |
| Fairchild® | MicroPak2™ | STEALTH™ | TRUECURRENT™* |
| Fairchild Semiconductor® | MillerDrive™ | SuperFET™ | µSerDes™ |
| FACT Quiet Series™ | MotionMax™ | SuperSOT™-3 | SerDes® |
| FACT® | Motion-SPM™ | SuperSOT™-6 | UHC® |
| FAST® | OptiHiT™ | SuperSOT™-8 | Ultra FRFET™ |
| FastvCore™ | OPTOLOGIC® | SupreMOS™ | UniFET™ |
| FETBench™ | OPTOPLANAR® | SyncFET™ | VCX™ |
| FlashWriter®* | PDP SPM™ | Sync-Lock™ | VisualMax™ |
| FPS™ | | | XS™ |

*Trademarks of System General Corporation, used under license by Fairchild Semiconductor.

DISCLAIMER

FAIRCHILD SEMICONDUCTOR RESERVES THE RIGHT TO MAKE CHANGES WITHOUT FURTHER NOTICE TO ANY PRODUCTS HEREIN TO IMPROVE RELIABILITY, FUNCTION, OR DESIGN. FAIRCHILD DOES NOT ASSUME ANY LIABILITY ARISING OUT OF THE APPLICATION OR USE OF ANY PRODUCT OR CIRCUIT DESCRIBED HEREIN; NEITHER DOES IT CONVEY ANY LICENSE UNDER ITS PATENT RIGHTS, NOR THE RIGHTS OF OTHERS. THESE SPECIFICATIONS DO NOT EXPAND THE TERMS OF FAIRCHILD'S WORLDWIDE TERMS AND CONDITIONS, SPECIFICALLY THE WARRANTY THEREIN, WHICH COVERS THESE PRODUCTS.

LIFE SUPPORT POLICY

FAIRCHILD'S PRODUCTS ARE NOT AUTHORIZED FOR USE AS CRITICAL COMPONENTS IN LIFE SUPPORT DEVICES OR SYSTEMS WITHOUT THE EXPRESS WRITTEN APPROVAL OF FAIRCHILD SEMICONDUCTOR CORPORATION.

As used here in:

- Life support devices or systems are devices or systems which, (a) are intended for surgical implant into the body or (b) support or sustain life, and (c) whose failure to perform when properly used in accordance with instructions for use provided in the labeling, can be reasonably expected to result in a significant injury of the user.
- A critical component in any component of a life support, device, or system whose failure to perform can be reasonably expected to cause the failure of the life support device or system, or to affect its safety or effectiveness.

ANTI-COUNTERFEITING POLICY

Fairchild Semiconductor Corporation's Anti-Counterfeiting Policy. Fairchild's Anti-Counterfeiting Policy is also stated on our external website, www.Fairchildsemi.com, under Sales Support.

Counterfeiting of semiconductor parts is a growing problem in the industry. All manufactures of semiconductor products are experiencing counterfeiting of their parts. Customers who inadvertently purchase counterfeit parts experience many problems such as loss of brand reputation, substandard performance, failed application, and increased cost of production and manufacturing delays. Fairchild is taking strong measures to protect ourselves and our customers from the proliferation of counterfeit parts. Fairchild strongly encourages customers to purchase Fairchild parts either directly from Fairchild or from Authorized Fairchild Distributors who are listed by country on our web page cited above. Products customers buy either from Fairchild directly or from Authorized Fairchild Distributors are genuine parts, have full traceability, meet Fairchild's quality standards for handling and storage and provide access to Fairchild's full range of up-to-date technical and product information. Fairchild and our Authorized Distributors will stand behind all warranties and will appropriately address and warranty issues that may arise. Fairchild will not provide any warranty coverage or other assistance for parts bought from Unauthorized Sources. Fairchild is committed to combat this global problem and encourage our customers to do their part in stopping this practice by buying direct or from authorized distributors.

PRODUCT STATUS DEFINITIONS

Definition of Terms

Datasheet Identification	Product Status	Definition
Advance Information	Formative / In Design	Datasheet contains the design specifications for product development. Specifications may change in any manner without notice.
Preliminary	First Production	Datasheet contains preliminary data; supplementary data will be published at a later date. Fairchild Semiconductor reserves the right to make changes at any time without notice to improve design.
No Identification Needed	Full Production	Datasheet contains final specifications. Fairchild Semiconductor reserves the right to make changes at any time without notice to improve the design.
Obsolete	Not In Production	Datasheet contains specifications on a product that is discontinued by Fairchild Semiconductor. The datasheet is for reference information only.

Rev. I48

ON Semiconductor and  are trademarks of Semiconductor Components Industries, LLC dba ON Semiconductor or its subsidiaries in the United States and/or other countries. ON Semiconductor owns the rights to a number of patents, trademarks, copyrights, trade secrets, and other intellectual property. A listing of ON Semiconductor's product/patent coverage may be accessed at www.onsemi.com/site/pdf/Patent-Marking.pdf. ON Semiconductor reserves the right to make changes without further notice to any products herein. ON Semiconductor makes no warranty, representation or guarantee regarding the suitability of its products for any particular purpose, nor does ON Semiconductor assume any liability arising out of the application or use of any product or circuit, and specifically disclaims any and all liability, including without limitation special, consequential or incidental damages. Buyer is responsible for its products and applications using ON Semiconductor products, including compliance with all laws, regulations and safety requirements or standards, regardless of any support or applications information provided by ON Semiconductor. "Typical" parameters which may be provided in ON Semiconductor data sheets and/or specifications can and do vary in different applications and actual performance may vary over time. All operating parameters, including "Typicals" must be validated for each customer application by customer's technical experts. ON Semiconductor does not convey any license under its patent rights nor the rights of others. ON Semiconductor products are not designed, intended, or authorized for use as a critical component in life support systems or any FDA Class 3 medical devices or medical devices with a same or similar classification in a foreign jurisdiction or any devices intended for implantation in the human body. Should Buyer purchase or use ON Semiconductor products for any such unintended or unauthorized application, Buyer shall indemnify and hold ON Semiconductor and its officers, employees, subsidiaries, affiliates, and distributors harmless against all claims, costs, damages, and expenses, and reasonable attorney fees arising out of, directly or indirectly, any claim of personal injury or death associated with such unintended or unauthorized use, even if such claim alleges that ON Semiconductor was negligent regarding the design or manufacture of the part. ON Semiconductor is an Equal Opportunity/Affirmative Action Employer. This literature is subject to all applicable copyright laws and is not for resale in any manner.

PUBLICATION ORDERING INFORMATION

LITERATURE FULFILLMENT:

Literature Distribution Center for ON Semiconductor
19521 E. 32nd Pkwy, Aurora, Colorado 80011 USA
Phone: 303-675-2175 or 800-344-3860 Toll Free USA/Canada
Fax: 303-675-2176 or 800-344-3867 Toll Free USA/Canada
Email: orderlit@onsemi.com

N. American Technical Support: 800-282-9855 Toll Free
USA/Canada
Europe, Middle East and Africa Technical Support:
Phone: 421 33 790 2910
Japan Customer Focus Center
Phone: 81-3-5817-1050

ON Semiconductor Website: www.onsemi.com
Order Literature: <http://www.onsemi.com/orderlit>
For additional information, please contact your local
Sales Representative