



FEATURES

- RoHS compliant
- 1.0μH to 1.0mH
- Up to 10A I_{bc}
- Bobbin format
- Surface mount
- Integral EMI shield
- Compact size
- Tape and reel packaging
- UL 94V-0 materials
- J-STD-020-C reflow

DESCRIPTION

The 4800S series is a range of bobbin-wound, surface-mount inductors designed for use in switching power supply, and power line filter circuits. The parts are suitable for any application requiring a high saturation current in a low-profile package. The devices have an integral ferrite shield to reduce EMI.

PIN CONNECTIONS (TOP VIEW)

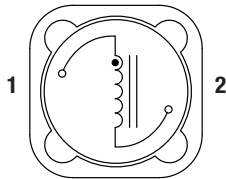

SELECTION GUIDE

Order Code	Inductance (10kHz, 100mV _{AC}) ±20%	DC Current ¹	DC Resistance	SRF	Q Factor	
	Nom.	Max.	Max.	Typ.	Typ.	
	μH	A	mΩ	MHz	Q	@ f (MHz)
481R0SC	1.0 (±30%)	10.0	6	83	35	1
482R2SC	2.2 (±30%)	8.2	10	48	36	1
483R3SC	3.3 (±30%)	7.3	12	39	34	1
484R7SC	4.7 (±30%)	6.3	16	28	34	1
486R8SC	6.8 (±30%)	5.1	21	26	34	1
48100SC	10	4.5	28	20	32	1
48150SC	15	3.7	40	17	31	1
48220SC	22	3.1	53	13	31	1
48330SC	33	2.8	73	11	31	1
48470SC	47	2.4	100	10	32	1
48680SC	68	1.8	145	9	33	1
48101SC	100	1.6	200	7	20	0.8
48151SC	150	1.35	280	6	23	0.8
48221SC	220	1.00	430	5	23	0.8
48331SC	330	0.85	630	5	22	0.8
48471SC	470	0.76	900	4	20	0.8
48681SC	680	0.66	1250	4	18	0.8
48102SC	1000	0.52	1850	4	17	0.8

MECHANICAL DIMENSIONS

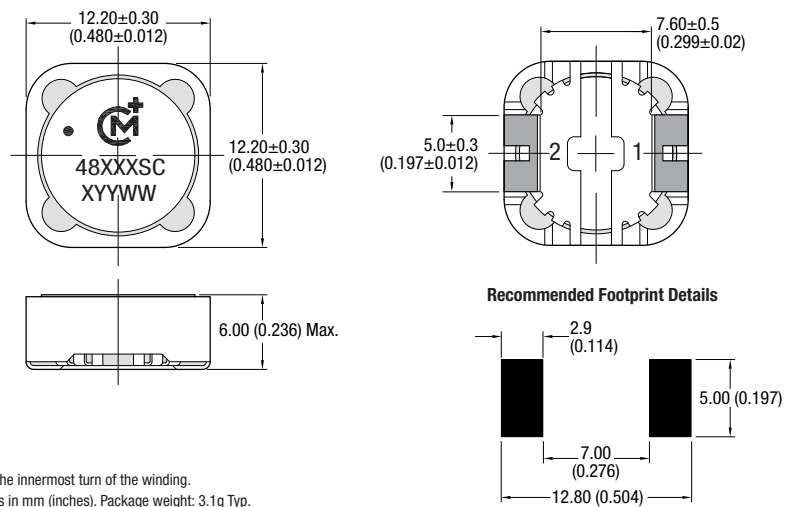

ABSOLUTE MAXIMUM RATINGS

Operating free air temperature range	-40°C to 85°C
Storage temperature range	-40°C to 125°C

SOLDERING INFORMATION²

Peak reflow solder temperature	245°C
Pin finish	Tin

Specifications typical at T_a = 25°C

- 1 Maximum DC current occurs when either the inductance falls to 75% of its nominal value or when its temperature rise reaches 40°C, whichever is sooner.
- 2 For further information, please visit www.murata-ps.com/rohs



For full details go to
www.murata-ps.com/rohs

INDUCTANCE Vs CURRENT

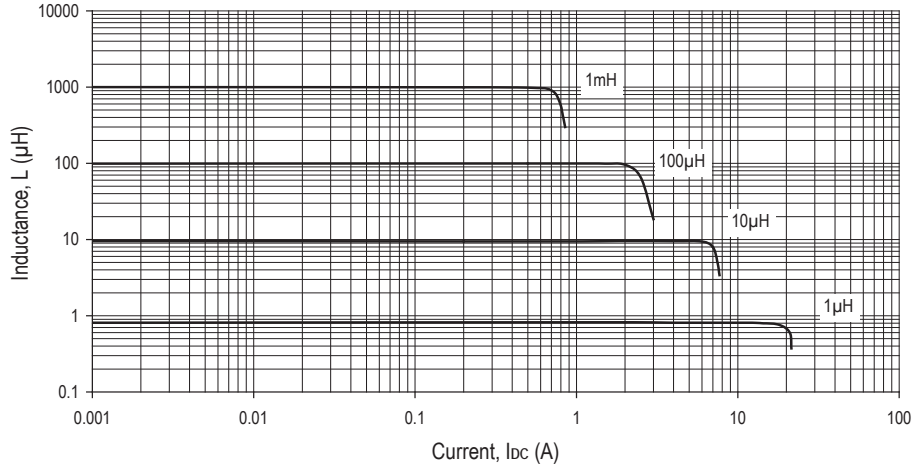

TEMPERATURE Vs CURRENT

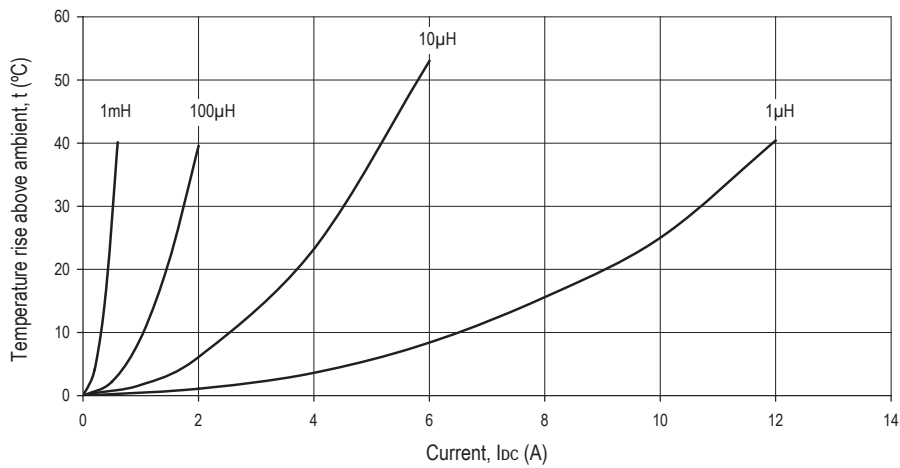

INDUCTANCE Vs FREQUENCY

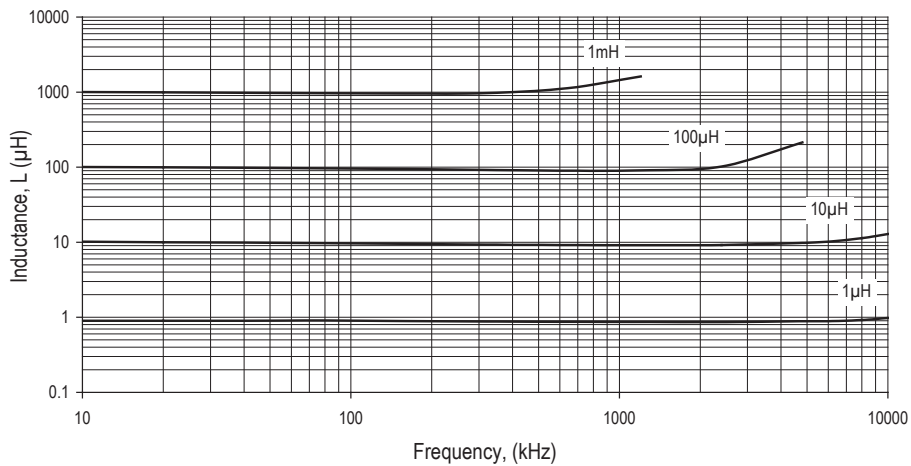

TAPE & REEL SPECIFICATIONS

REEL OUTLINE DIMENSIONS

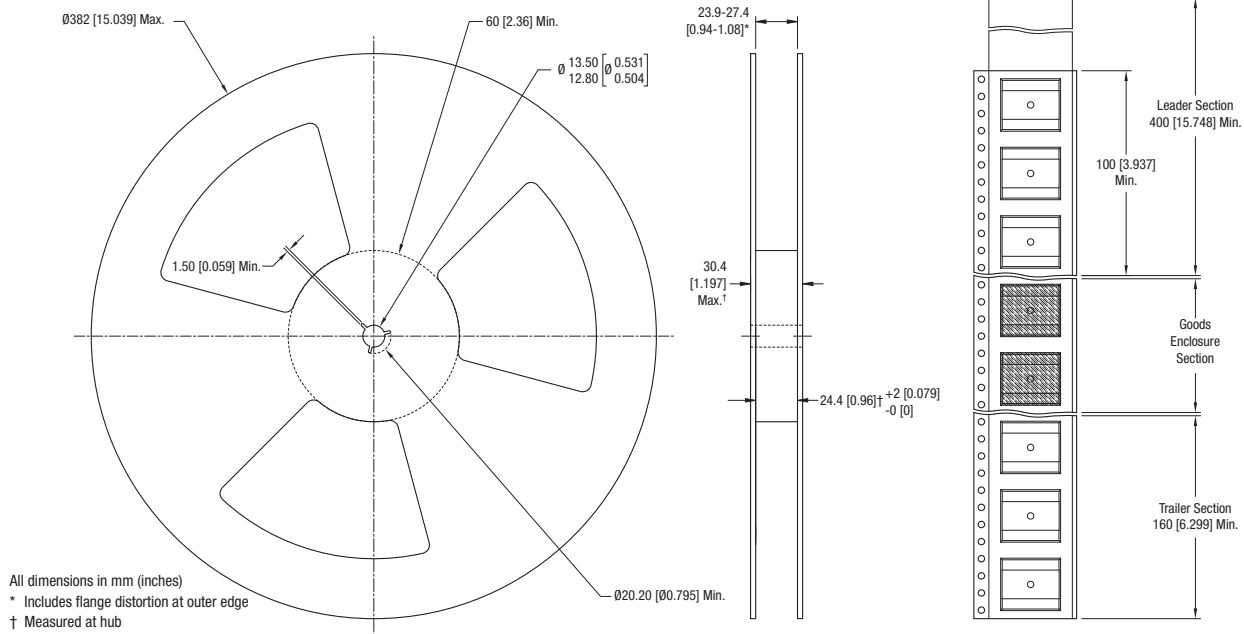

TAPE OUTLINE DIMENSIONS

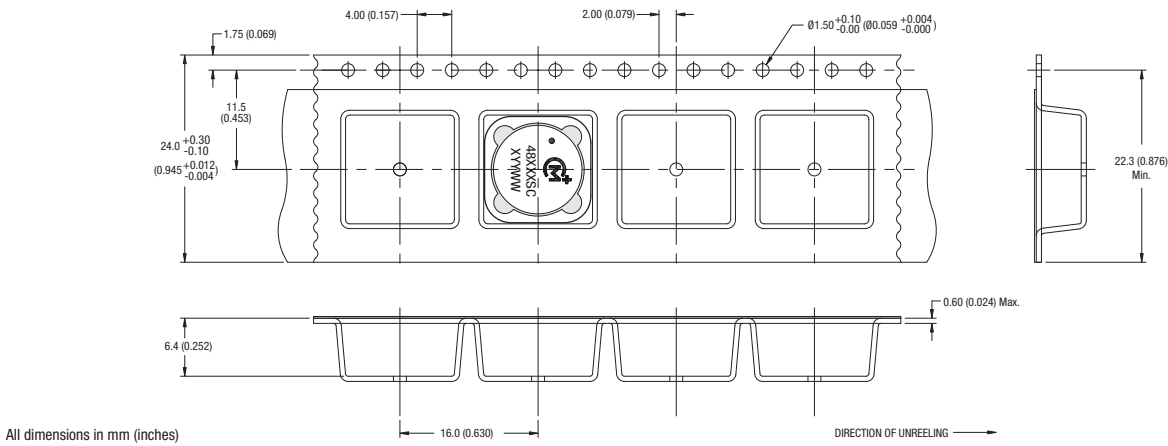

This product is subject to the following **operating requirements** and the **Life and Safety Critical Application Sales Policy**:

Refer to: <http://www.murata-ps.com/requirements/>

Murata Power Solutions, Inc. makes no representation that the use of its products in the circuits described herein, or the use of other technical information contained herein, will not infringe upon existing or future patent rights. The descriptions contained herein do not imply the granting of licenses to make, use, or sell equipment constructed in accordance therewith. Specifications are subject to change without notice. © 2018 Murata Power Solutions, Inc.