

## Description

Very cost effective design to meet international requirements. No exposed metal parts which are, or could become, current-carrying except for terminals. R-type TO CBE to EN 60934.

- Manual reset, cycling trip free mechanism
- Extremely small and lightweight
- UL, CSA, VDE and EN 60934 (IEC 60934) approved

## Typical applications

Battery chargers, consumer products, power supplies, motors.

## Ordering information

### Type No.

1658 single pole thermal circuit breaker

#### Threadneck design

**G21** manual reset type, 3/8"-27 threadneck

**A00** auto reset type, without threadneck

#### Hardware

**00** no hardware

**01** one PAL nut Y306 671 01, bulk

**02** one PAL nut Y306 671 01,  
one knurled nut Y307 117 02, bulk

#### Terminals

**P10** blade terminals A6.3-0.8 (QC .250)

**P13** blade terminals A6.3-0.8 (QC .250), 90°

#### Current ratings

**5 ...30 A**

1658 - G21 - 02 - P10 - 5 A Ordering example

\* Screws and lock washers bulk shipped

Packaging unit: minimum order 250 pieces

## Preferred types

Preferred types	Standard current ratings (A)											
	5	6	7	8	9	10	12	15	16	20	25	30
1658-G21-02-P10-	x	x	x	x	x	x	x	x	x	x	x	x
1658-G21-02-P13-	x	x	x	x	x	x	x	x	x			
1658-A00-00-P10-	x	x	x	x	x	x	x	x	x			

## Standard current ratings and typical voltage drop values

Current rating (A)	voltage drop values (mV)	Current rating (A)	voltage drop values (mV)
5	≤ 250	12	≤ 250
6	≤ 250	15	≤ 250
7	≤ 250	16	≤ 250
8	≤ 250	20	≤ 250
9	≤ 250	25	≤ 250
10	≤ 250	30	≤ 250



1658-...

## Technical data

For further details please see chapter: Technical Information

Voltage rating	AC 240 V; DC 28 V		
Current ratings	5...30 A		
Typical life	AC + DC 5...16 A 1,000 operations at $2 \times I_N$ , inductive 17...25 A 1,000 operations at $2 \times I_N$ , resistive		
Behaviour at rated switching capacity (EN 60934; test sequence D)	operat.	$I_N$	$U_N$
	40	5...16 A	AC 240 V 6 x $I_N$ ind
	40	5...16 A	DC 28 V 4 x $I_N$ ind
	40	17...25 A	AC 240 V 120 A resistive
	40	17...25 A	DC 28 V 120 A resistive
Ambient temperature	-20...+60 °C (-4...+140 °F), ≤ 7 A max. +40 °C (+104 °F)		
Insulation co-ordination (IEC 60664 and 60664 A)	rated impulse withstand voltage	pollution degree	2
	2.5 kV	reinforced insulation in operating area	
Dielectric strength (IEC 60664 and 60664A)	test voltage	operating area AC 3,000 V	
Insulation resistance	> 100 MΩ (DC 500 V)		
Interrupting capacity $I_{cn}$	5...7 A	180 A	
	8...30 A	200 A	
Interrupting capacity (UL 1077/EN 60934 PC1)	$I_N$	$U_N$	
	5...16 A	AC 240 V	2,000 A
	5...30 A	AC 120 V	2,000 A
	5...30 A	DC 32 V	2,500 A
	5...30 A	DC 28 V	2,000 A (1658-A..)
Degree of protection (IEC 60529/DIN 40050)	operating area IP40 terminal area IP00		
Vibration	8 g (57-500 Hz) ± 0.61 mm (10-57 Hz), to IEC 60068-2-6, test Fc, 10 frequency cycles/axis		
Shock	30 g (11 ms) to IEC 60068-2-27, test Ea		
Corrosion	96 hours at 5 % salt mist, to IEC 60068-2-11, test Ka		
Humidity	240 hours at 95 % RH to IEC 60068-2-78, test Cab		
Mass	approx. 16 g		

## Dimensions

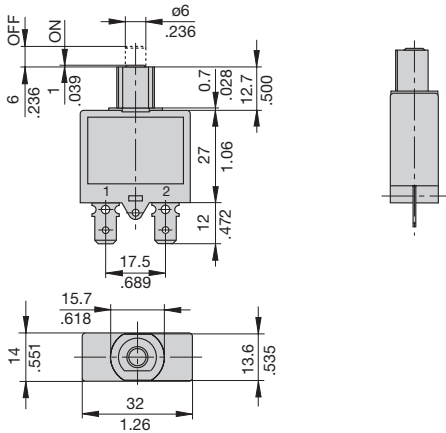

**A00**



**G21** tightening torque max. 0.8 Nm  
3/8-27UNS-2A

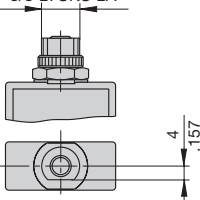

See ordering information for mounting hardware.

## Terminal design

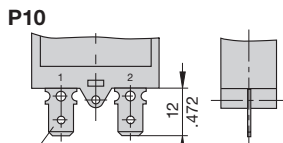

blade terminals DIN 46244-A6.3-0.8  
(QC .250)

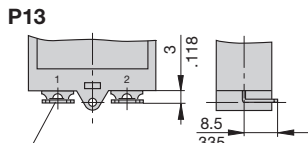

blade terminals DIN 46244-A6.3-0.8 (QC .250)  
angled 90°

## Installation drawing

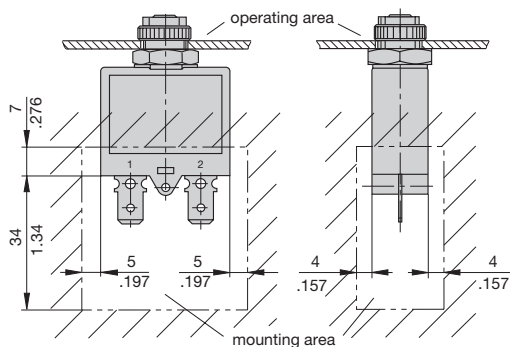

## Internal connection diagram

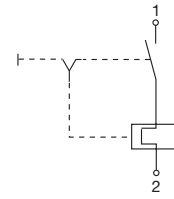

## Typical time/current characteristics

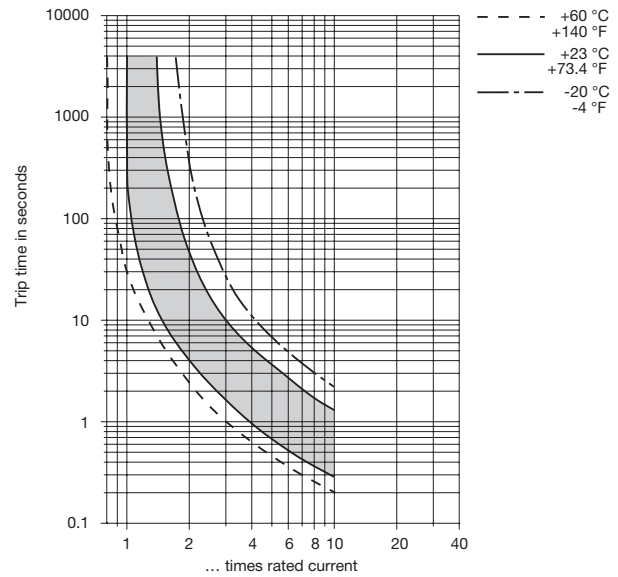

The time/current characteristic curve depends on the ambient temperature prevailing. In order to eliminate nuisance tripping, please multiply the circuit breaker current ratings by the derating factor shown below. See also section Technical information.

Ambient temp. °F	-4	+14	+32	+73.4	+104	+122	+140
Ambient temp. °C	-20	-10	0	+23	+40	+50	+60
Derating factor $I_N > 7A$	0.83	0.85	0.9	1	1.1	1.18	1.25
Derating factor $I_N < 7A$	0.74	0.76	0.82	1	1.23	-	-

This is a metric design and millimeter dimensions take precedence ( $\frac{\text{mm}}{\text{inch}}$ )

**Accessories**

**PAL nut 3/8", 27-thread**  
Y 306 671 01

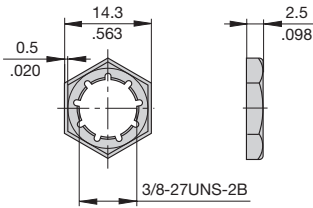

**Knurled nut 3/8", 27-thread plastic (standard)**  
Y 307 117 02

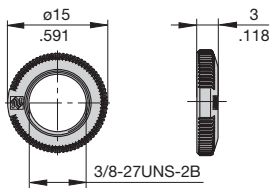

**Knurled nut 3/8", 27-thread nickel-plated brass**  
Y 300 190 03

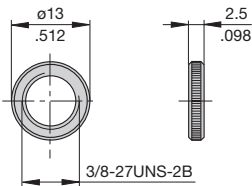

**Hex nut 3/8", 27-thread nickel-plated brass**  
Y 300 192 01

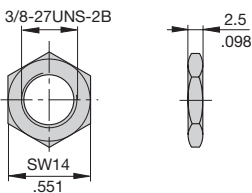

**Press to Reset Plate for 3/8" thread, aluminium**  
Y 301 059 02

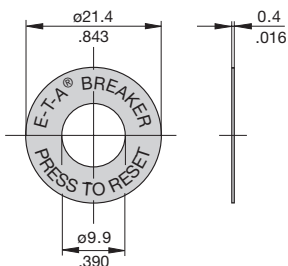

**Reset button seal for 3/8", 27-thread, short**  
X 201 285 01 (IP64)

**long**  
X 200 799 01 (IP64)

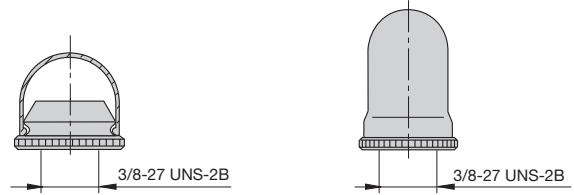

**Panel cut out**

**1658-3/8-27 UNS-2A**

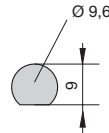

**Approvals**

Authority	Voltage ratings	Current ratings
VDE (EN 60934)	AC 240 V; DC 28 V	5...25 A
UL	AC 240 V AC 120 V AC 120 V DC 32 V DC 28 V	5...16 A 1658-G.. 18...30 A 1658-G.. 5...30 A 1658-A.. 5...30 A 1658-G.. 5...30 A 1658-A..

This is a metric design and millimeter dimensions take precedence ( $\frac{mm}{inch}$ )

All dimensions without tolerances are for reference only. In the interest of improved design, performance and cost effectiveness the right to make changes in these specifications without notice is reserved. Product markings may not be exactly as the ordering codes. Errors and omissions excepted.

