

## Long distance proximity sensor

### ■ Features

- Long sensing distance  
(1.5 to 2 times longer sensing distance guaranteed compared to existing models)
- Improved the noise resistance with dedicated IC
- Built-in surge protection, reverse polarity protection, overcurrent protection circuit
- Long life cycle and high reliability
- Red LED status indication
- Protection structure IP67(IEC standard)
- Replaceable for micro switches and limit switches
- Improved cable strain relief : More reliable flexural strength of sensor/cable connecting part



⚠ Please read "Caution for your safety" in operation manual before using.



### ■ Specifications

#### ● DC 2-wire type

Model	PRDT12-4 □ O PRDT12-4 □ C PRDT12-4 □ O-V PRDT12-4 □ C-V PRDLT12-4 □ O PRDLT12-4 □ C PRDLT12-4 □ O-V PRDLT12-4 □ C-V PRDWT12-4 □ O PRDWT12-4 □ C PRDWT12-4 □ O-I PRDWT12-4 □ C-I PRDWT12-4 □ O-IV PRDWT12-4 □ C-IV	PRDT12-8 □ O PRDT12-8 □ C PRDT12-8 □ O-V PRDT12-8 □ C-V PRDLT12-8 □ O PRDLT12-8 □ C PRDLT12-8 □ O-V PRDLT12-8 □ C-V PRDWT12-8 □ O PRDWT12-8 □ C PRDWT12-8 □ O-I PRDWT12-8 □ C-I PRDWT12-8 □ O-IV PRDWT12-8 □ C-IV	PRDT18-7 □ O PRDT18-7 □ C PRDT18-7 □ O-V PRDT18-7 □ C-V PRDLT18-7 □ O PRDLT18-7 □ C PRDLT18-7 □ O-V PRDLT18-7 □ C-V PRDWT18-7 □ O PRDWT18-7 □ C PRDWT18-7 □ O-I PRDWT18-7 □ C-I PRDWT18-7 □ O-IV PRDWT18-7 □ C-IV PRDWLT18-7 □ O-IV PRDWLT18-7 □ C-IV	PRDT18-14 □ O PRDT18-14 □ C PRDT18-14 □ O-V PRDT18-14 □ C-V PRDLT18-14 □ O PRDLT18-14 □ C PRDLT18-14 □ O-V PRDLT18-14 □ C-V PRDWT18-14 □ O PRDWT18-14 □ C PRDWT18-14 □ O-I PRDWT18-14 □ C-I PRDWT18-14 □ O-IV PRDWT18-14 □ C-IV PRDWLT18-14 □ O-IV PRDWLT18-14 □ C-IV	PRDT30-15 □ O PRDT30-15 □ C PRDT30-15 □ O-V PRDT30-15 □ C-V PRDLT30-15 □ O PRDLT30-15 □ C PRDLT30-15 □ O-V PRDLT30-15 □ C-V PRDWT30-15 □ O PRDWT30-15 □ C PRDWT30-15 □ O-I PRDWT30-15 □ C-I PRDWT30-15 □ O-IV PRDWT30-15 □ C-IV	PRDT30-25 □ O PRDT30-25 □ C PRDT30-25 □ O-V PRDT30-25 □ C-V PRDLT30-25 □ O PRDLT30-25 □ C PRDLT30-25 □ O-V PRDLT30-25 □ C-V PRDWT30-25 □ O PRDWT30-25 □ C PRDWT30-25 □ O-I PRDWT30-25 □ C-I PRDWT30-25 □ O-IV PRDWT30-25 □ C-IV
Sensing distance	4mm	8mm	7mm	14mm	15mm	25mm
Hysteresis	Max. 10% of sensing distance					
Standard sensing target	12×12×1mm(Iron)	25×25×1mm (Iron)	20×20×1mm (Iron)	40×40×1mm (Iron)	45×45×1mm (Iron)	75×75×1mm (Iron)
Sensing distance	0 to 2.8mm	0 to 5.6mm	0 to 4.9mm	0 to 9.8mm	0 to 10.5mm	0 to 17.5mm
Power supply (Operating voltage)	12-24VDC (10-30VDC)					
Leakage current	Max. 0.6mA					
Response frequency <sup>*1</sup>	450Hz	400Hz	250Hz	200Hz	100Hz	
Residual voltage <sup>*2</sup>	Max. 3.5V(for non-polarity type, max. 5V)					
Affection by Temp.	Max. ±10% for sensing distance at ambient temperature 20°C					
Control output	2 to 100mA					
Insulation resistance	Min. 50MΩ(at 500VDC megger)					
Dielectric strength	1500VAC 50/60Hz for 1minute					
Vibration	1mm amplitude at frequency of 10 to 55Hz(for 1 min.) in each of X, Y, Z directions for 2 hours					
Shock	500m/s <sup>2</sup> (approx. 50G) X, Y, Z directions for 3 times					
Indicator	Operation indicator(red LED)					
Environment	Ambient temperature: -25 to 70°C, Storage: -30 to 80°C Ambient humidity: 35 to 95%RH, Storage: 35 to 95%RH					
Protection circuit	Surge protection circuit, Reverse polarity protection circuit, Overcurrent protection circuit					
Material	Case/Nut: Nickel plated Brass, Washer: Nickel plated Iron, Sensing surface: Heat-resistant ABS, Standard cable(Black): Polyvinyl chloride(PVC), Oil resistant cable(Gray): Oil resistant Polyvinyl chloride(PVC)					
Cable	ø4, 2-wire, 2m (For cable type, 300mm, M12 connector), (AWG22, Core diameter: 0.08mm, Number of cores: 60, Insulator diameter: ø1.25) ø5, 2-wire, 2m					
Approval	CE					
Protection	IP67(IEC Standard)					
Unit weight	PRDT: Approx. 74g PRDLT: Approx. 94g PRDWT: Approx. 44g	PRDT: Approx. 72g PRDLT: Approx. 92g PRDWT: Approx. 42g	PRDT: Approx. 115g PRDLT: Approx. 145g PRDWT: Approx. 80g PRDWLT: Approx. 42g	PRDT: Approx. 110g PRDLT: Approx. 140g PRDWT: Approx. 75g PRDWLT: Approx. 105g	PRDT: Approx. 175g PRDLT: Approx. 215g PRDWT: Approx. 140g	PRDT: Approx. 180g PRDLT: Approx. 220g PRDWT: Approx. 145g

\*1: The response frequency is the average value. The standard sensing target is used and the width is set as 2 times of the standard sensing target, 1/2 of the sensing distance for the distance.

\*2: Before using non-polarity type, check the condition of connected device because residual voltage is 5V.

※ The '□' of model name is for power type. 'D' is 12-24VDC, 'X' is non-polarity 12-24VDC.

※ The last 'V' of model name is for the model with oil-resistance reinforced cable.

※ Environment resistance is rated at no freezing or condensation.

(A)	Photo electric sensor
(B)	Fiber optic sensor
(C)	Door/Area sensor
(D)	Proximity sensor
(E)	Pressure sensor
(F)	Rotary encoder
(G)	Connector/Socket
(H)	Temp. controller
(I)	SSR/Power controller
(J)	Counter
(K)	Timer
(L)	Panel meter
(M)	Tacho/Speed/Pulse meter
(N)	Display unit
(O)	Sensor controller
(P)	Switching mode power supply
(Q)	Stepper motor& Driver&Controller
(R)	Graphic/Logic panel
(S)	Field network device
(T)	Software
(U)	Other

# PRD/PRDW Series

## ■ Specifications

### ● DC 3-wire type

Model	PRD12-4DN PRD12-4DP PRD12-4DN2 PRD12-4DP2 PRDL12-4DN PRDL12-4DP PRDL12-4DN2 PRDL12-4DP2 PRDW12-4DN PRDW12-4DP PRDW12-4DN2 PRDW12-4DP2 PRDW12-4DN-V PRDW12-4DP-V PRDWL12-4DN PRDWL12-4DP PRDWL12-4DN2 PRDWL12-4DP2	PRD12-8DN PRD12-8DP PRD12-8DN2 PRD12-8DP2 PRDL12-8DN PRDL12-8DP PRDL12-8DN2 PRDL12-8DP2 PRDW12-8DN PRDW12-8DP PRDW12-8DN2 PRDW12-8DP2 PRDW12-8DN-V PRDW12-8DP-V PRDWL12-8DN PRDWL12-8DP PRDWL12-8DN2 PRDWL12-8DP2	PRD18-7DN PRD18-7DP PRD18-7DN2 PRD18-7DP2 PRDL18-7DN PRDL18-7DP PRDL18-7DN2 PRDL18-7DP2 PRDW18-7DN PRDW18-7DP PRDW18-7DN2 PRDW18-7DP2 PRDW18-7DN-V PRDW18-7DP-V PRDWL18-7DN PRDWL18-7DP PRDWL18-7DN2 PRDWL18-7DP2	PRD18-14DN PRD18-14DP PRD18-14DN2 PRD18-14DP2 PRDL18-14DN PRDL18-14DP PRDL18-14DN2 PRDL18-14DP2 PRDW18-14DN PRDW18-14DP PRDW18-14DN2 PRDW18-14DP2 PRDW18-14DN-V PRDW18-14DP-V PRDWL18-14DN PRDWL18-14DP PRDWL18-14DN2 PRDWL18-14DP2	PRD30-15DN PRD30-15DP PRD30-15DN2 PRD30-15DP2 PRDL30-15DN PRDL30-15DP PRDL30-15DN2 PRDL30-15DP2 PRDW30-15DN PRDW30-15DP PRDW30-15DN2 PRDW30-15DP2 PRDW30-15DN-V PRDW30-15DP-V PRDWL30-15DN PRDWL30-15DP PRDWL30-15DN2 PRDWL30-15DP2	PRD30-25DN PRD30-25DP PRD30-25DN2 PRD30-25DP2 PRDL30-25DN PRDL30-25DP PRDL30-25DN2 PRDL30-25DP2 PRDW30-25DN PRDW30-25DP PRDW30-25DN2 PRDW30-25DP2 PRDW30-25DN-V PRDW30-25DP-V PRDWL30-25DN PRDWL30-25DP PRDWL30-25DN2 PRDWL30-25DP2
Sensing distance	4mm	8mm	7mm	14mm	15mm	25mm
Hysteresis	Max. 10% of sensing distance					
Standard sensing target	12×12×1mm(Iron)	25×25×1mm(Iron)	20×20×1mm (Iron)	40×40×1mm (Iron)	45×45×1mm (Iron)	75×75×1mm (Iron)
Sensing distance	0 to 2.8mm	0 to 5.6mm	0 to 4.9mm	0 to 9.8mm	0 to 10.5mm	0 to 17.5mm
Power supply (Operating voltage)	12-24VDC (10-30VDC)					
Current consumption	Max. 10mA					
Response frequency*1	500Hz	400Hz	300Hz	200Hz	100HZ	100Hz
Residual voltage	Max. 1.5V					
Affection by Temp.	Max. ±10% for sensing distance at ambient temperature 20°C					
Control output	200mA					
Insulation resistance	Min. 50MΩ(at 500VDC megger)					
Dielectric strength	1500VAC 50/60Hz for 1minute					
Vibration	1mm amplitude at frequency of 10 to 55Hz(for 1 min.) in each of X, Y, Z directions for 2 hours					
Shock	500m/s <sup>2</sup> (approx. 50G) X, Y, Z directions for 3 times					
Indicator	Operation indicator(red LED)					
Environ- ment	Ambient temperature	-25 to 70°C, Storage: -30 to 80°C				
	Ambient humidity	35 to 95%RH, Storage: 35 to 95%RH				
Protection circuit	Surge protection circuit, Reverse polarity protection circuit, Overcurrent protection circuit					
Protection	IP67(IEC Standard)					
Material	Case/Nut: Nickel plated Brass, Washer: Nickel plated Iron, Sensing surface: Heat-resistant ABS, Standard cable(Black): Polyvinyl chloride(PVC), Oil resistant cable(Gray): Oil resistant Polyvinyl chloride(PVC)					
Cable	ø4, 3-wire, 2m		ø5, 3-wire, 2m			
	(For cable type, 300mm, M12 connector), (AWG22, Core diameter: 0.08mm, Number of cores: 60, Insulator diameter: ø1.25)					
Approval	CE					
Unit weight	PRD: Approx. 74g PRDL: Approx. 94g PRDW: Approx. 44g PRDWL: Approx. 64g	PRD: Approx. 72g PRDL: Approx. 92g PRDW: Approx. 42g PRDWL: Approx. 62g	PRD: Approx. 115g PRDL: Approx. 145g PRDW: Approx. 80g PRDWL: Approx. 110g	PRD: Approx. 110g PRDL: Approx. 140g PRDW: Approx. 75g PRDWL: Approx. 105g	PRD: Approx. 175g PRDL: Approx. 215g PRDW: Approx. 140g PRDWL: Approx. 180g	PRD: Approx. 180g PRDL: Approx. 220g PRDW: Approx. 145g PRDWL: Approx. 185g

\*1: The response frequency is the average value. The standard sensing target is used and the width is set as 2 times of the standard sensing target, 1/2 of the sensing distance for the distance.

※The last 'V' of model name is for the model with oil-resistance reinforced cable.

※Environment resistance is rated at no freezing or condensation.

## ■ Dimensions

(unit: mm)

### ● PRD(T)12-4D□

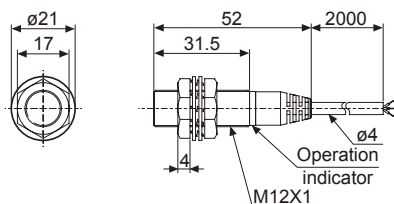

### ● PRD(T)12-8D□

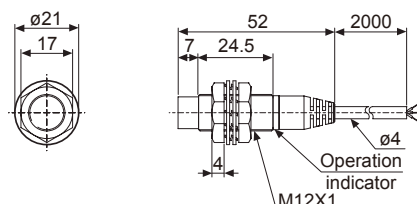

# Long Distance Type

## ■ Dimensions

(unit: mm)

### ● PRDL(T)12-4D

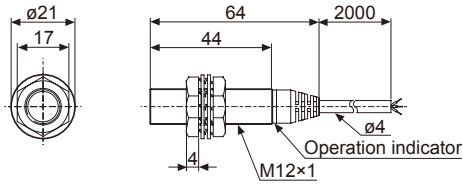

### ● PRDL(T)12-8D

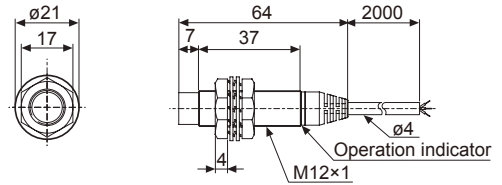

### ● PRD(T)18-7D

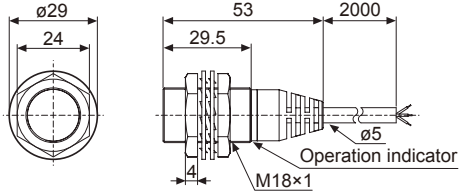

### ● PRD(T)18-14D

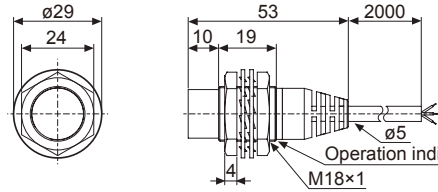

### ● PRDL(T)18-7D

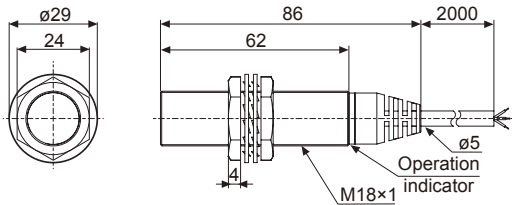

### ● PRDL(T)18-14D

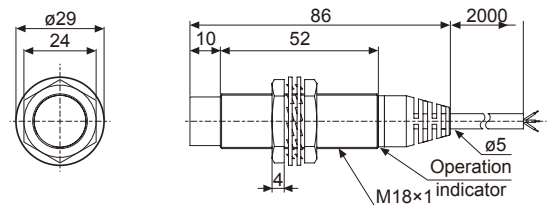

### ● PRD(T)30-15D

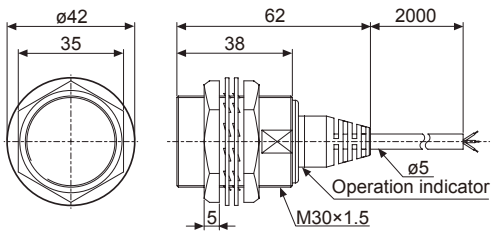

### ● PRD(T)30-25D

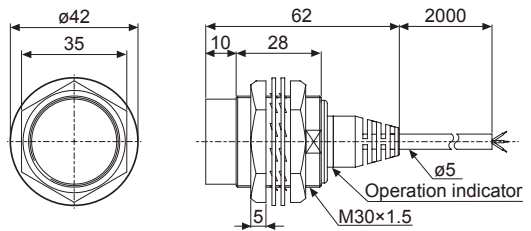

### ● PRDL(T)30-15D

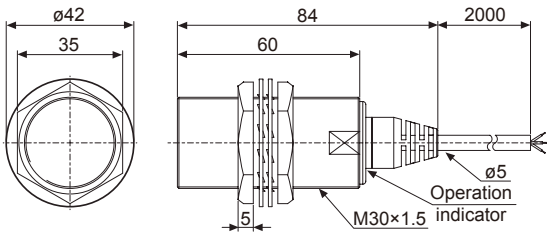

### ● PRDL(T)30-25D

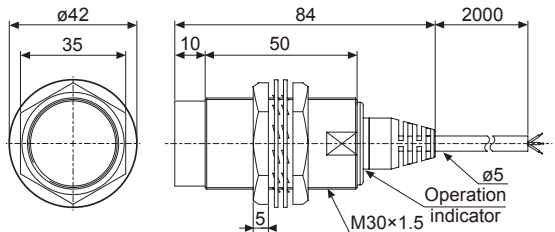

### ● PRDW(T)12-4D

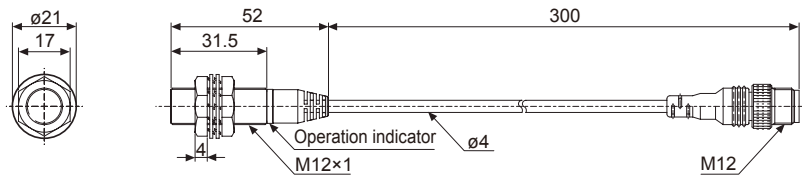

### ● PRDW(T)12-8D

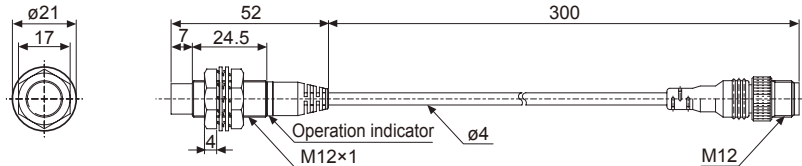

(A) Photo electric sensor

(B) Fiber optic sensor

(C) Door/Area sensor

(D) Proximity sensor

(E) Pressure sensor

(F) Rotary encoder

(G) Connector/Socket

(H) Temp. controller

(I) SSR/ Power controller

(J) Counter

(K) Timer

(L) Panel meter

(M) Tacho/ Speed/ Pulse meter

(N) Display unit

(O) Sensor controller

(P) Switching mode power supply

(Q) Stepper motor & Driver&Controller

(R) Graphic/ Logic panel

(S) Field network device

(T) Software

(U) Other

# PRD/PRDW Series

## ■ Dimensions

(unit: mm)

### ● PRDWL12-4D

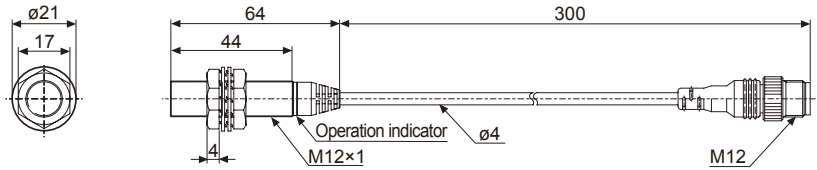

### ● PRDWL12-8D

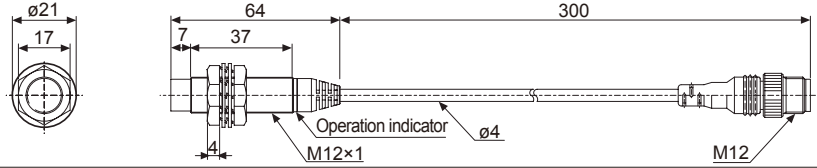

### ● PRDW(T)18-7D

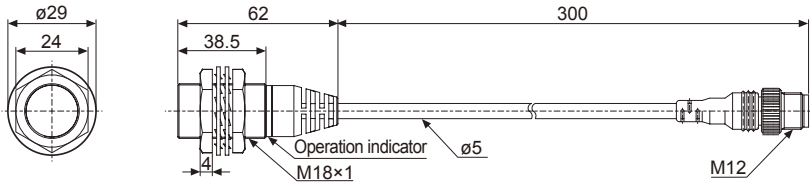

### ● PRDW(T)18-14D

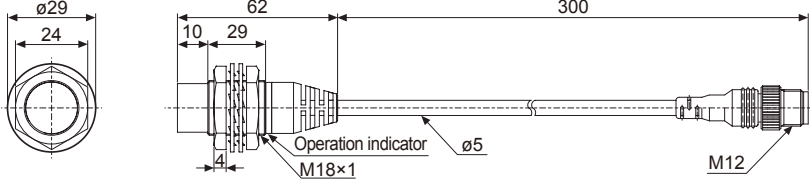

### ● PRDWL(T)18-7D

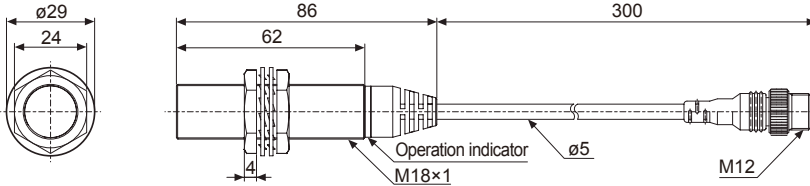

### ● PRDWL(T)18-14D

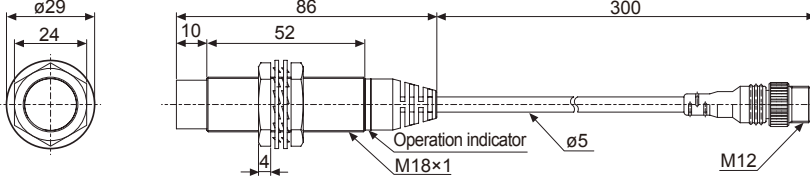

### ● PRDW(T)30-15D

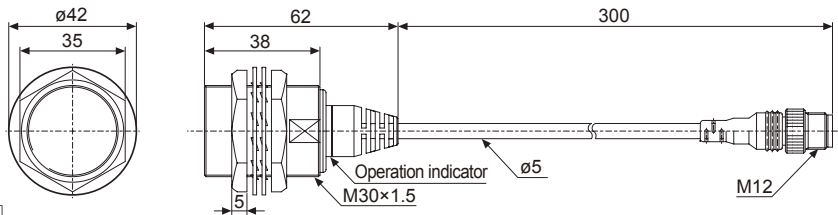

### ● PRDW(T)30-25D

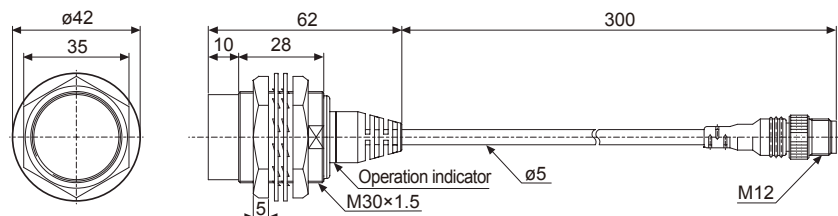

# Long Distance Type

## Dimensions

(unit: mm)

### PRDWL(T)30-15D

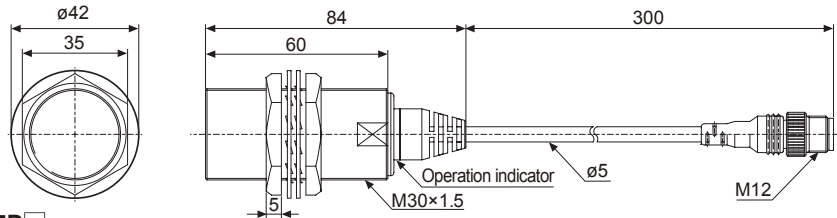

### PRDWL(T)30-25D

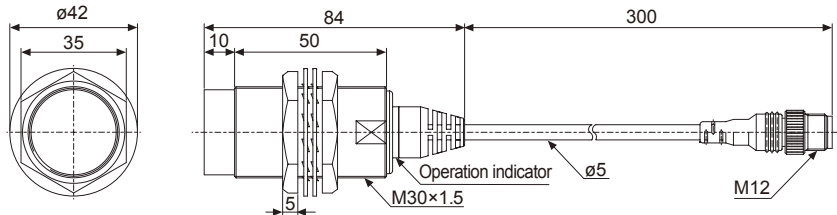

## Control output diagram

### DC 2-wire type

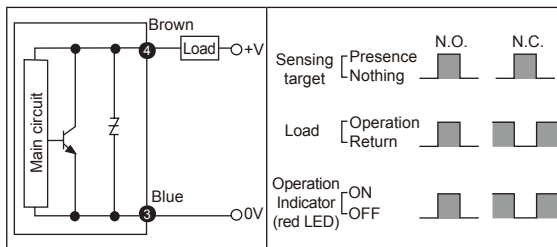

※ The number in a circle is pin no. of connector.

### DC 3-wire type

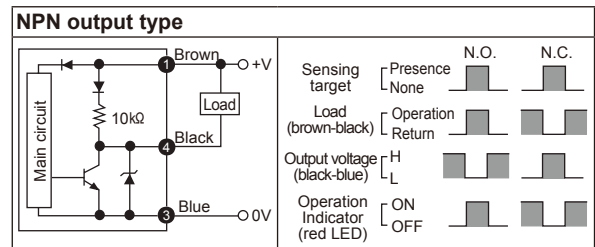

### PNP output type

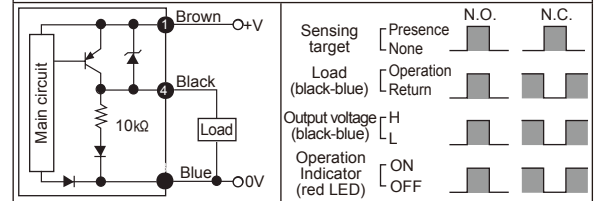

## Connections

### DC 2-wire type

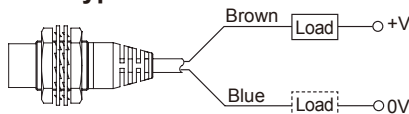

※ The load can be connected to either wire.

### DC 3-wire type

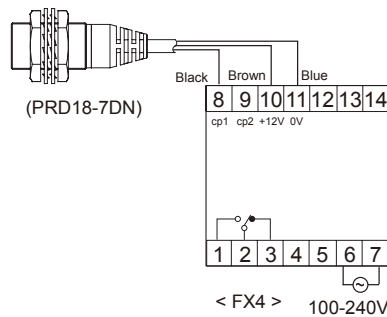
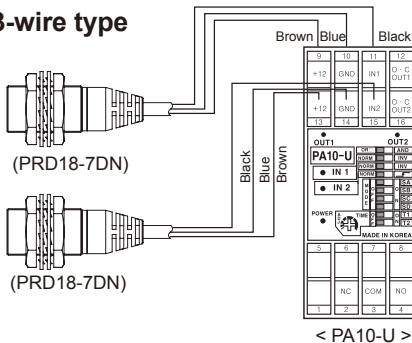

(A) Photo electric sensor

(B) Fiber optic sensor

(C) Door/Area sensor

(D) Proximity sensor

(E) Pressure sensor

(F) Rotary encoder

(G) Connector/Socket

(H) Temp. controller

(I) SSR/ Power controller

(J) Counter

(K) Timer

(L) Panel meter

(M) Tacho/ Speed/ Pulse meter

(N) Display unit

(O) Sensor controller

(P) Switching mode power supply

(Q) Stepper motor& Driver&Controller

(R) Graphic/ Logic panel

(S) Field network device

(T) Software

(U) Other

# PRD/PRDW Series

## ■ Wiring diagram

### ◎ DC 2-wire type(Standard type)

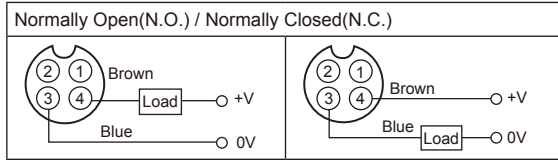

※Pin ①, ② are not used terminals.

※For DC 3-wire type connector cable, it is available to use with black wire(12-24VDC) and blue wire(0V).

### ◎ DC 2-wire type(IEC standard type)

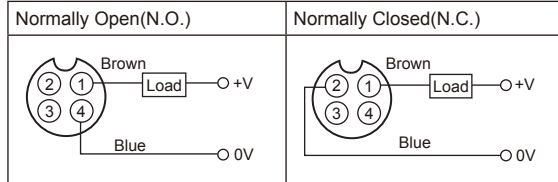

※②, ③ of N.O. type and ③, ④ of N.C. type are not used terminals.

※The pin arrangement of connector applying IEC standard is being developed.

※Please attach "I" at the end of the name of standard type for purchasing the IEC standard product. Ex)PRDWT12-4DO-I

※The connector cable for IEC standard is being developed. Please attach "I" at the end of the name of standard type.

Ex)CID2-2-I, CLD2-5-I

## ■ Proper usage

### ◎ Load connections

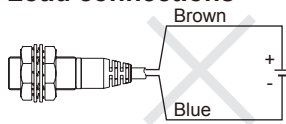

< DC 2-wire type >

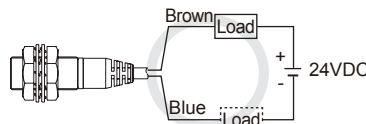

< DC 2-wire type >

### ◎ In case of the load current is small

#### ● DC 2-wire type

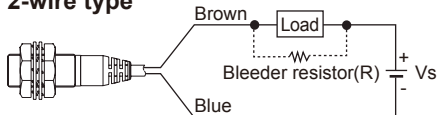

Please make the current on proximity sensor smaller than the return current of load by connecting a bleeder resistor in parallel.

※W value of Bleeder resistor should be bigger for proper heat dissipation.

$$R = \frac{V_s}{I_o - I_{off}} (\Omega) \quad P = \frac{V_s^2}{R} (W)$$

[  $V_s$  : Power supply,  $I_o$  : Min. action current of proximity sensor  
 $I_{off}$  : Return current of load, P : Number of Bleeder resistance watt ]

### ◎ Mutual-interference

When several proximity sensors are mounted close to one another a malfunction of the sensor may be caused due to mutual interference. Therefore, be sure to provide a minimum distance between the two sensors as below chart indicates.

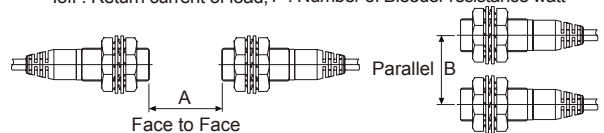

### ◎ Influence by surrounding metals

When sensors are mounted on metallic panel, you must prevent the sensors from being affected by any metallic object except target. Therefore, be sure to provide a minimum distance as below chart indicates.

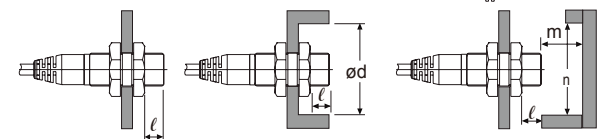

(unit: mm)

Model	PRDT12-4□□	PRDT12-8□□	PRDT18-7□□	PRDT18-14□□	PRDT30-15□□	PRDT30-25□□
Item	PRDWT12-4□□ PRDLT12-4□□	PRDWT12-8□□ PRDLT12-8□□	PRDWT18-7□□ PRDLT18-7□□ PRDWLT18-7□□	PRDWT18-14□□ PRDLT18-14□□ PRDWLT18-14□□	PRDWT30-15□□ PRDLT30-15□□	PRDWT30-25□□ PRDLT30-25□□
A	24	48	42	84	90	150
B	24	36	36	54	60	90
ℓ	0	11	0	14	0	15
ød	12	36	18	54	30	90
m	12	24	21	42	45	75
n	18	36	27	54	45	90